



Manufacturers & Suppliers of Standard and Customized Dental Instruments

Stellar[®]
Instruments Co.

ISO 9001:2008 CERTIFIED
CE-MARK





Stellar[®]
Instruments Co.

www.sialkotsurgical.com

Table Of Contents

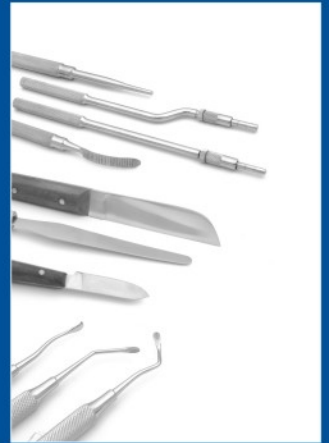





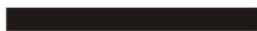









Table of Contents

| | | | |
|-----------|--|---------|--|
| 01 | Tooth Extracting Forceps | 01-49 | |
| 02 | Root Elevators | 50-70 | |
| 03 | Scalpel Handles, Handles, Mouth Mirrors Scalers, Explorer / Probes | 71-85 | |
| 04 | Endodontic Condensers, Obturation Instruments Excavators, Explorer / Probes, Curette Sets | 86-96 | |
| 05 | Amalgam Pluggers / Condensers, Burnishers | 97-100 | |
| 06 | Wax Carvers, Carvers, Chisels | 101-103 | |
| 07 | Compsite Placement, Plastic Filling Instruments | 104-107 | |
| 08 | Curettes, Gracey Curettes, Dental Products, Knives | 108-117 | |
| 09 | Wax Porcelain & Cement Instruments Wax & Modeling Instruments | 118-121 | |
| 10 | Spatulas, Cement Spatulas | 122-124 | |
| 11 | Files, Hoes, Knives, Wax & Plaster Knives, Crane Kaplan | 125-128 | |
| 12 | Bone Curettes, Bone Files, Bone Chisels, Bone Mallets | 129-133 | |
| 13 | Crown Removers, Crown Instruments | 134-136 | |





Table of Contents

| | | | |
|-----------|---|------------------|---|
| 14 | Implants & Measuring Instruments, Suction Tubes, Bone Gauges | 137-144 |  |
| 15 | Amalgam Guns & Carriers, Retainers, Bands, Strip Holders, Napkin Holders | 145-146 |  |
| 16 | Rubber Dam Instruments, Rubber Dam Clamps | 147-148 |  |
| 17 | Syringes, Tweezers, Sterilizing & Lab Instruments | 149-156 |  |
| 18 | Endodontic Forceps, Tissue Forceps, Haemostatic Forceps, Towel Clamps | 157-159 |  |
| 19 | Retractors, Lip & Cheek Retractors, Hooks, Depressors & Mouth Gags, Sterilizing Forceps | 160-164 |  |
| 20 | Orthodontic Pliers & Cutters, Rongeurs | 165-179 |  |
| 21 | Needle Holders, Scissors, Micro Surgery Set | 180-186 |  |
| 22 | Impression Trays | 187-193 |  |
| 23 | Articulators, Hollow Wares | 194-200 |  |
| 24 | Scissors, Dissecting Forceps, Needle Holders, Wire Cutting Pliers With Tungsten Carbide Inserts | 201-213 |  |
| 25 | Dental Implants Instruments | 214-216 |  |
| 26 | Dental Instruments Sets | 217 |  |





🦷 Extracting Forceps

🦷 Root Elevators



01
SECTION



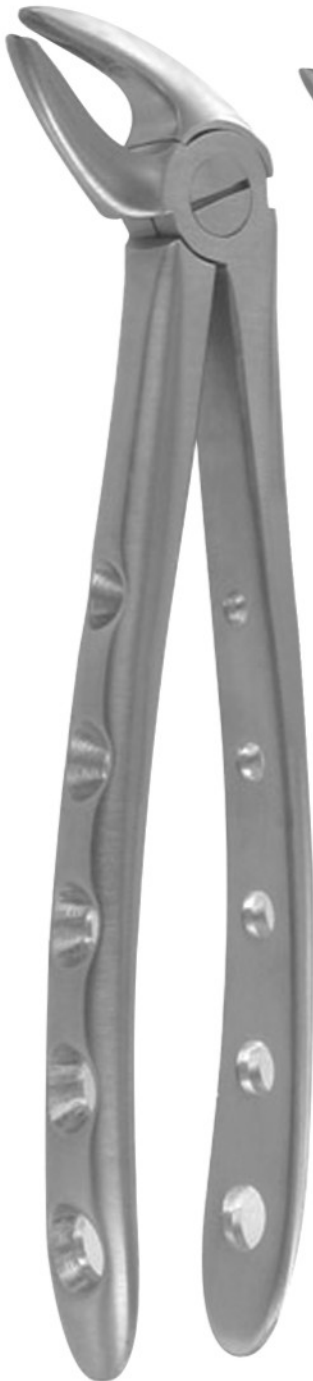

1001
Fig. 4
lower incisor



1001
Fig. 4
lower incisor



1002
Fig. 8
lower premolar



1002
Fig. 8
lower premolars



1003
Fig. 1
upper centrals & canines

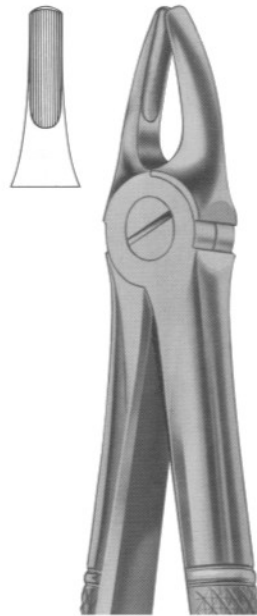

1004
Fig. 2
upper laterals & canines



1005
Fig. 3
upper incisors & canines



1006
Fig. 4
upper incisors & canines

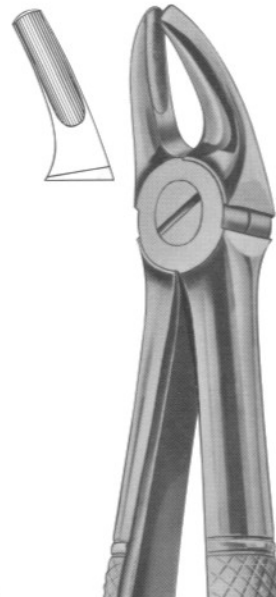

1007
Fig. 7
upper premolars

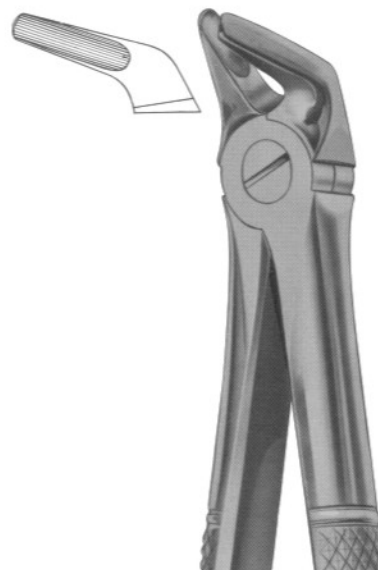

1008
Fig. 8
lower premolars

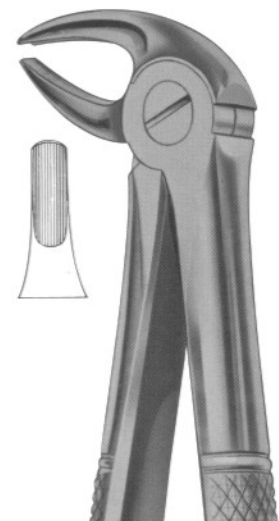

1009
Fig. 13
lower premolars



1010
Fig. 13S
lower premolars
for children.

1011
Fig. 17
upper molars, right

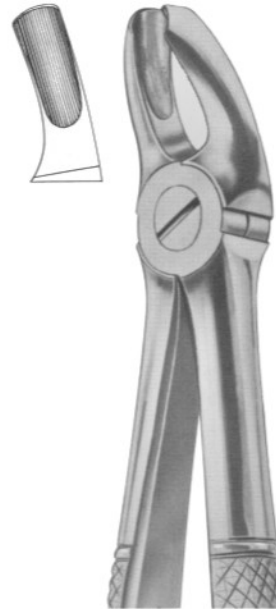

1012
Fig. 18
upper molars, left

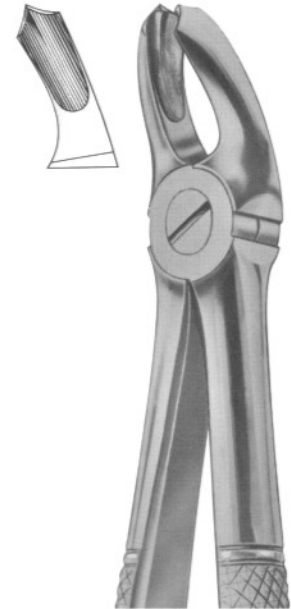

1013
Fig. 18A
upper molars

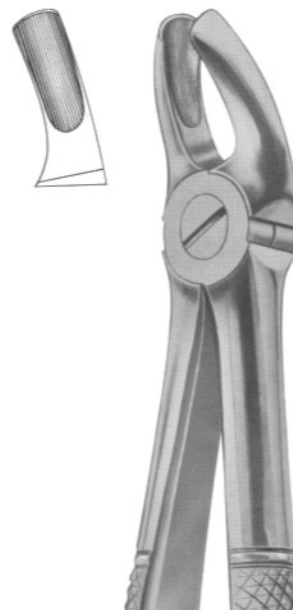

1014
Fig. 18B
upper molars

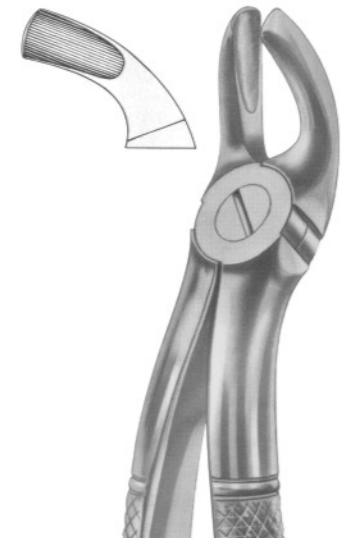

1015
Fig. 19
upper third molars



1016
Fig. 20
upper third molars

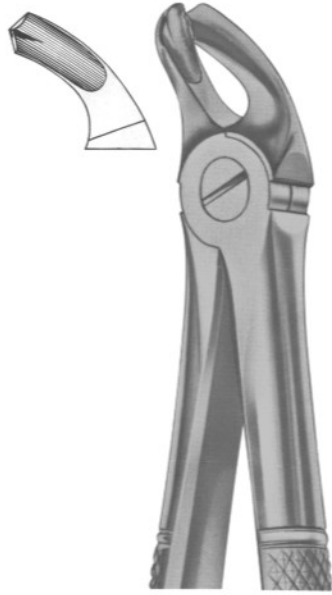

1017
Fig. 21
lower molars

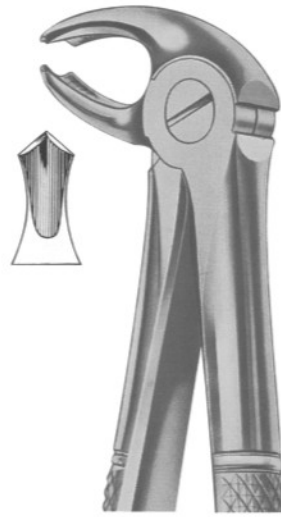

1018
Fig. 22
lower molars

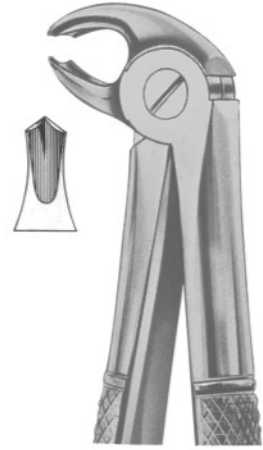

1019
Fig. 22S
lower molars
for children

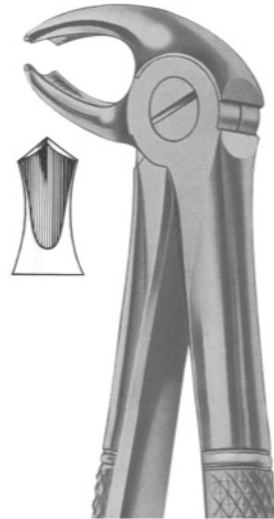

1020
Fig. 22G
lower molars

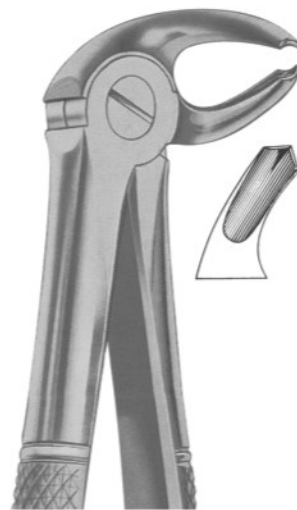

1021
Fig. 23
lower molars right

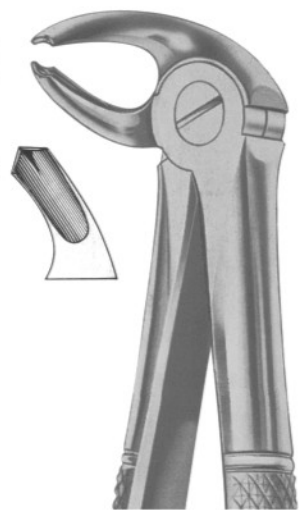

1022
Fig. 24
lower molars left



1023
Fig. 29
upper roots



1024
Fig. 29S
upper roots for children



1025
Fig. 30
upper roots

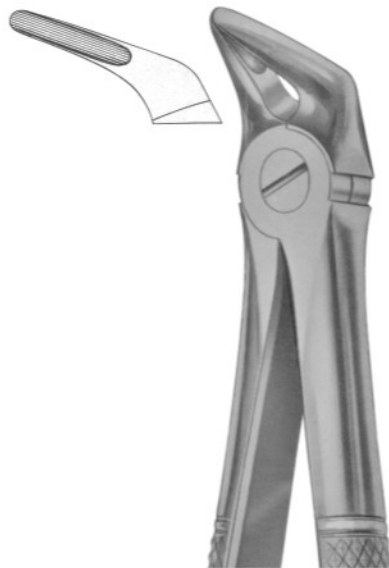

1026
Fig. 31
lower roots



1027
Fig. 32
lower molars



1028
Fig. 30S
upper roots for children



1029
Fig. 33
lower roots

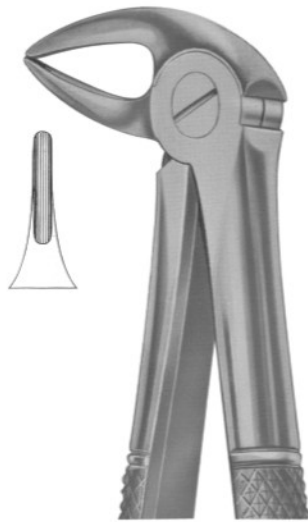

1030
Fig. 33A
lower roots

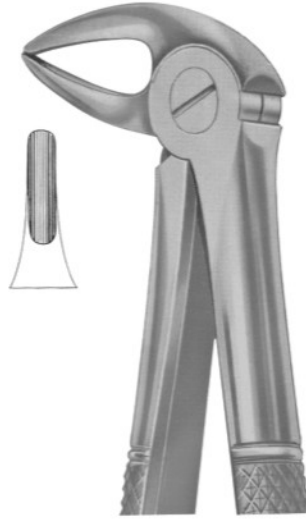

1031
Fig. 33B
lower roots

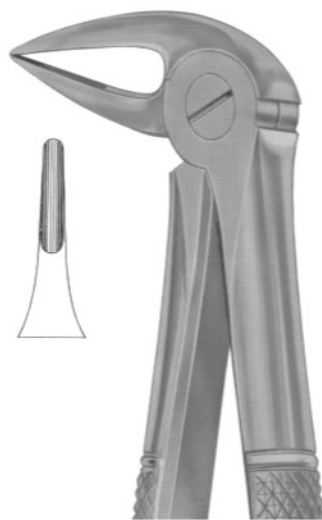

1032
Fig. 33L
lower roots



1033
Fig. 37
upper incisors
for children

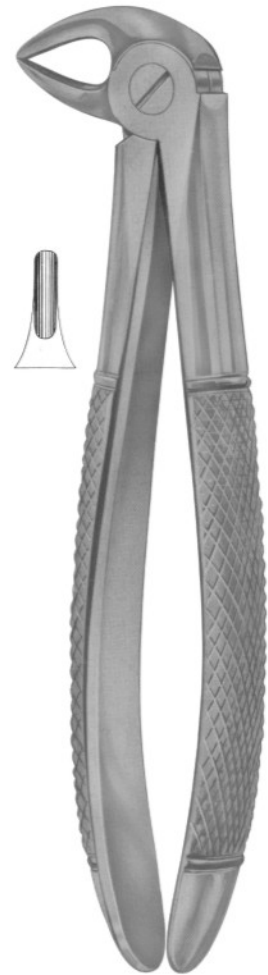

1034
Fig. 33S
lower roots
for children



1035
Fig. 38
lower incisors &
canines for children



1036
Fig. 39
upper molars
for children

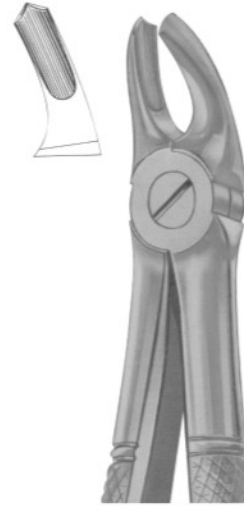

1037
Fig. 39R
upper molars right
for children



1040
Fig. 39L
upper molars left
for children



1038
Fig. 39A
upper molars
for children



1039
Fig. 40
lower molars
for children



1041
Fig. 41
upper roots

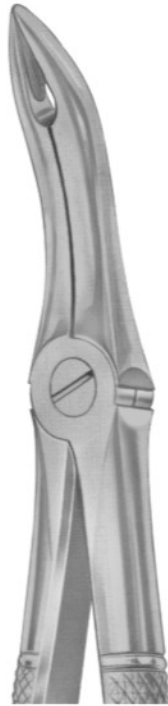

1042
Fig. 44
upper roots



1043
Fig. 45
lower roots



1046
Fig. 50
upper roots

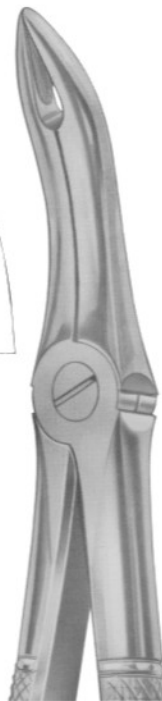

1044
Fig. 48
lower roots

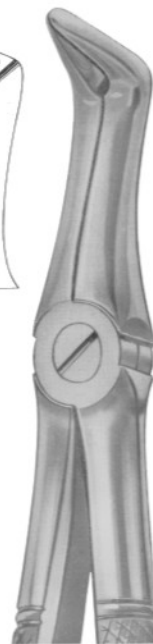

1045
Fig. 49
upper roots



1047
Fig. 51
upper roots

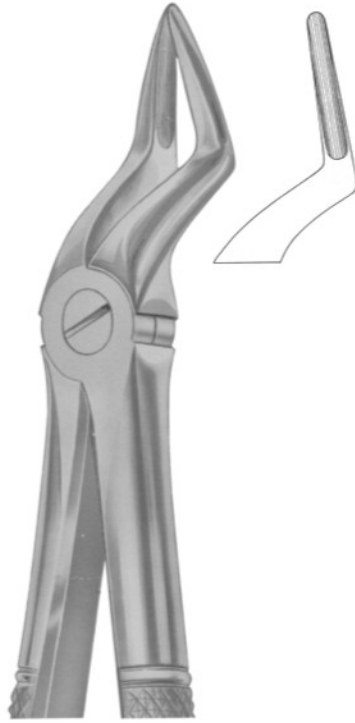

1048
Fig. 51A
upper roots

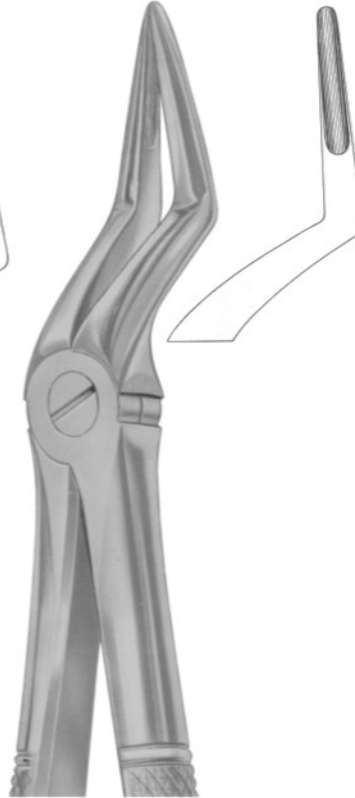

1049
Fig. 51L
upper roots

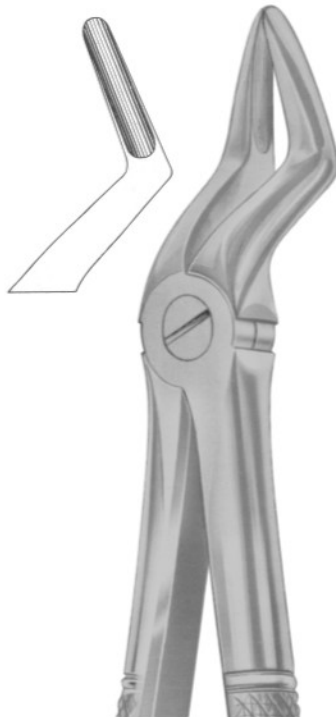

1050
Fig. 52
upper roots

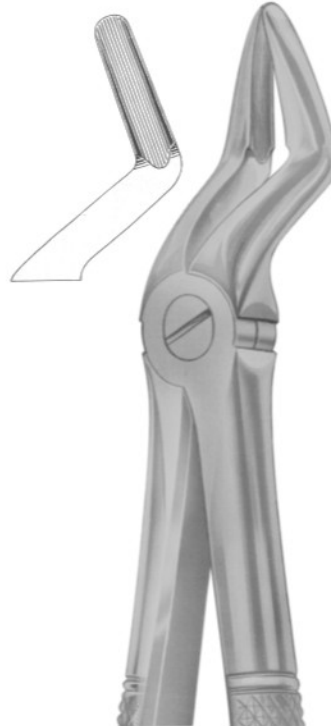

1051
Fig. 52A
upper teeth
and resection

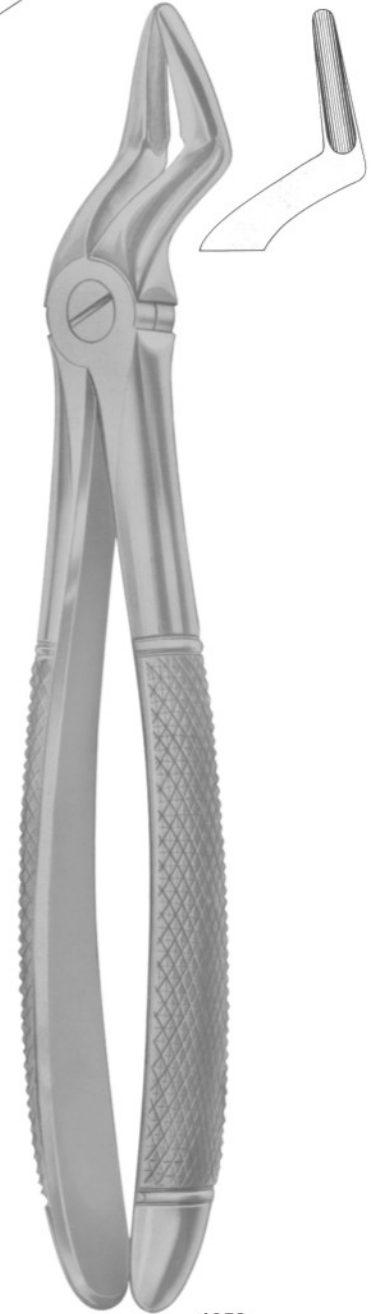

1052
Fig. 51S
upper roots
for children



1053
Fig. 54
for separating
upper molars



1054
Fig. 55
for separating
upper molars



1055
Fig. 56
for separating
lower molars

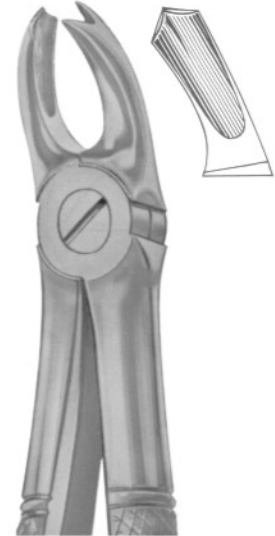

1056
Fig. 65R
upper molars
right



1057
Fig. 65L
upper molars left



1058
Fig. 67
upper third molars

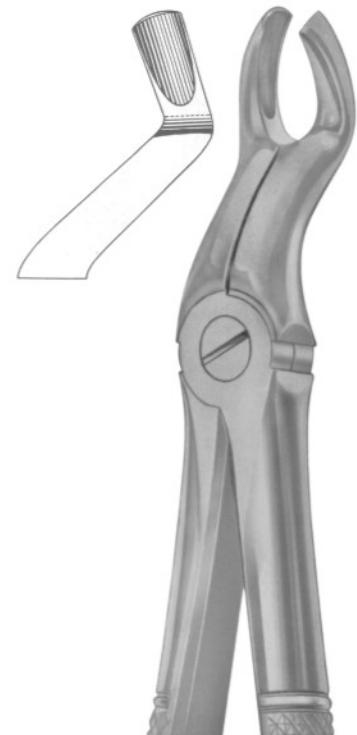

1059
Fig. 67A
upper third molars

**Extracting Forceps
"English Pattern"**



1060
Fig. 67 1/2R
upper third molars
right



1061
Fig. 67 1/2L
upper third molars
left



1062
Fig. 68
lower roots



1063
Fig. 68A
lower roots

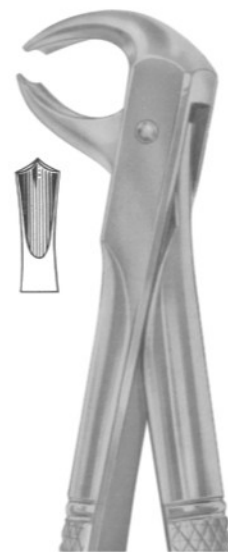

1064
Fig. 73
lower molars



1065
Fig. 73R
lower molars right

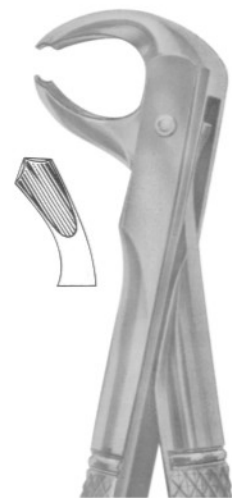

1066
Fig. 73L
lower molars left



1067
Fig. 73A
lower molars

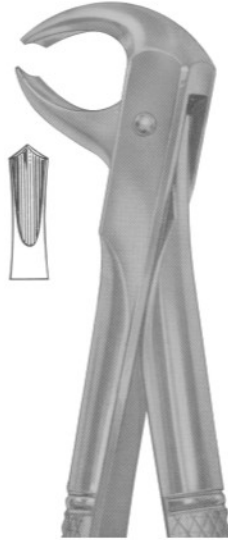

1068
Fig. 73S
lower molars

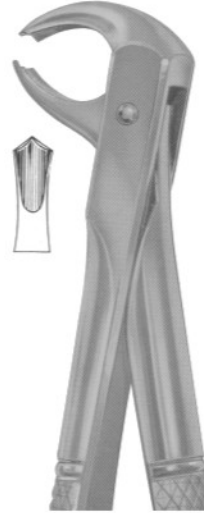

1069
Fig. 73B
lower molars for children

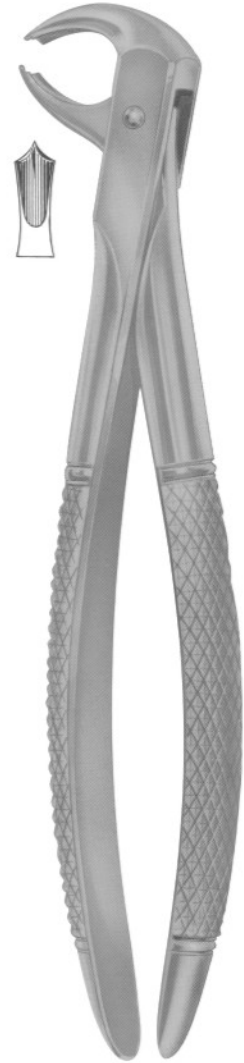

1072
Fig. 73K
lower molars
for children

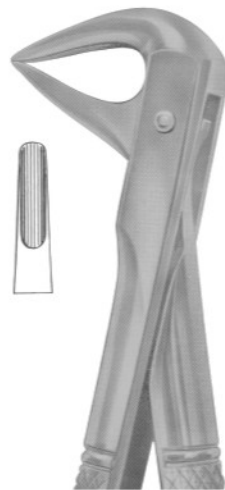

1070
Fig. 74
lower roots

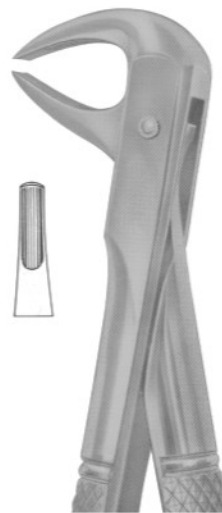

1071
Fig. 74D
lower roots



1073
Fig. 74M
lower roots

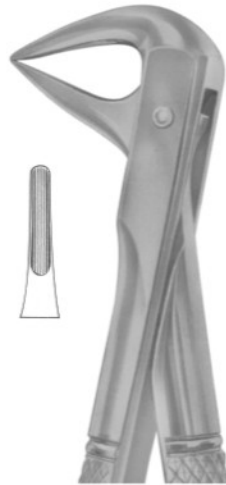

1074
Fig. 74N
lower roots

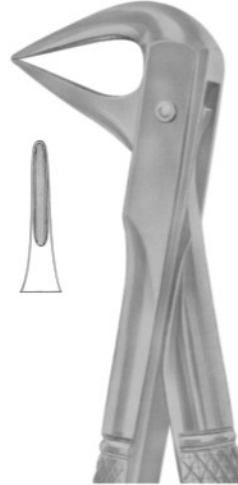

1075
Fig. 74XN
lower roots and
crowded incisors



1078
Fig. 76N
upper roots

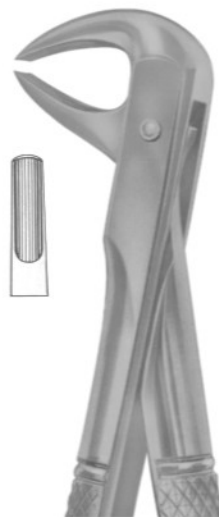

1076
Fig. 75
lower premolars



1077
Fig. 76
upper roots



1079
Fig. 76S
upper roots



1080
Fig. 79
lower third molars

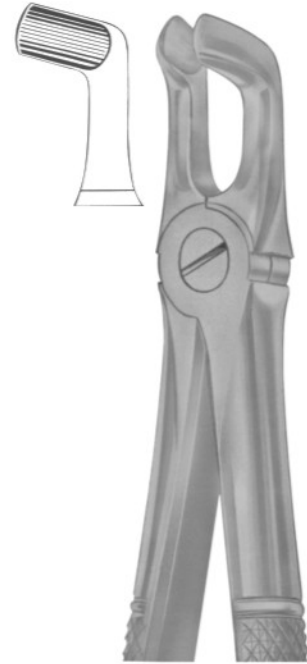

1081
Fig. 79A
lower third molars

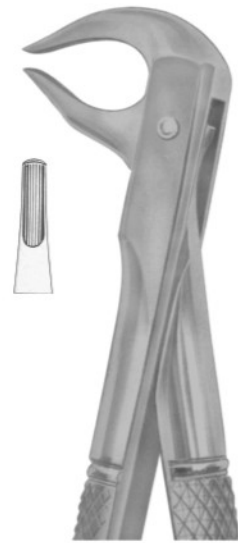

1082
Fig. 81
lower premolars
and roots



1083
Fig. 86A
lower molars



1084
Fig. 86B
lower molars



1085
Fig. 86C
lower molars



1086
Fig. 87
lower molars



1087
Fig. 91
for separating
lower molars



1088
Fig. 99
lower molars



1089
Fig. 101
upper premolars
and roots

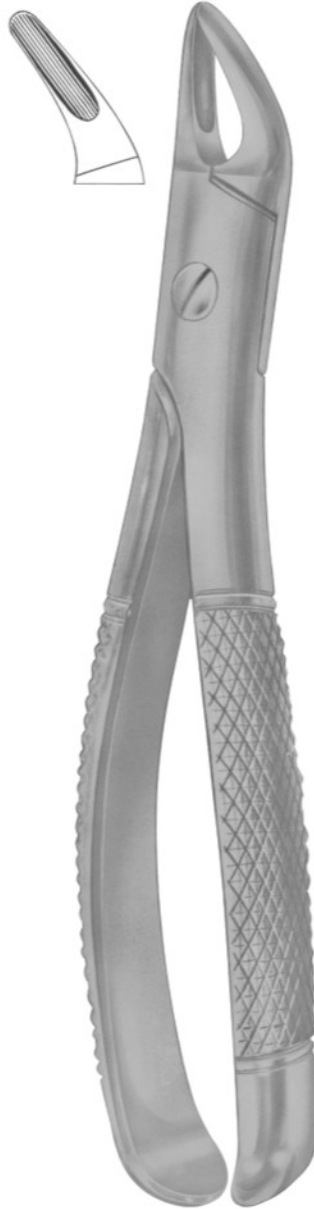

1090
Fig. 100
upper roots



1091
Fig. 99 1/4
lower molars

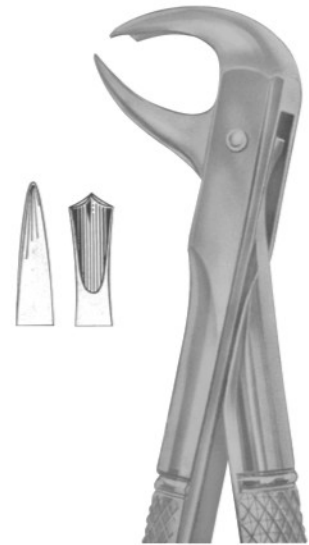

1092
Fig. 99 1/2
lower molars



Extracting Forceps "English Pattern"

Stellar
Instruments Co.

www.sialkotsurgical.com



1093
Fig. 102
upper molars right



1094
Fig. 103
upper molars left

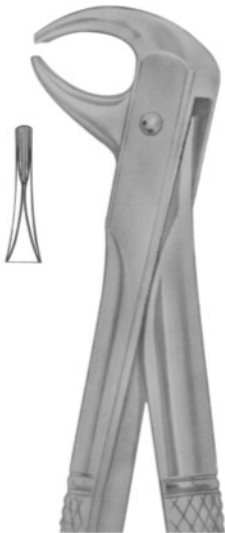

1095
Fig. 105
lower incisors

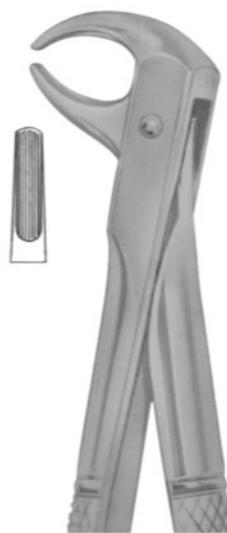

1096
Fig. 106
lower incisors



1097
Fig. 103
upper canines

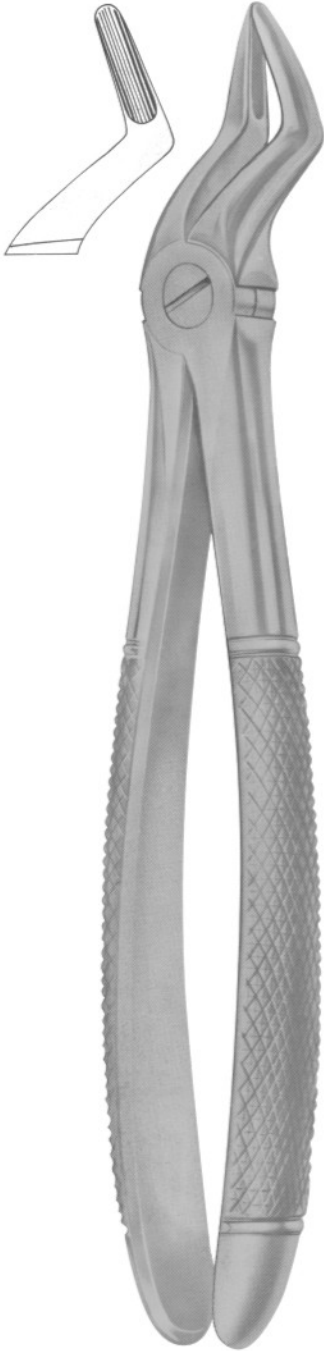

1098
Fig. 112
upper roots

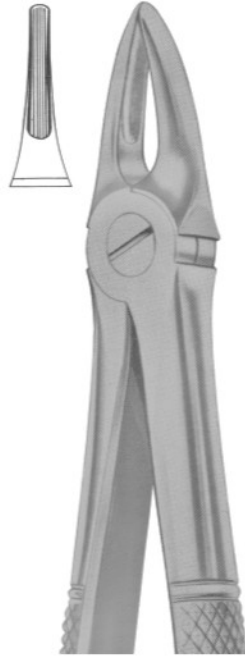

1099
Fig. 113
upper roots



1101
Fig. 136
upper premolars
and roots

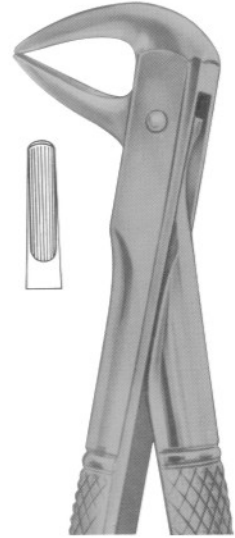

1102
Fig. 137
lower incisors
and roots

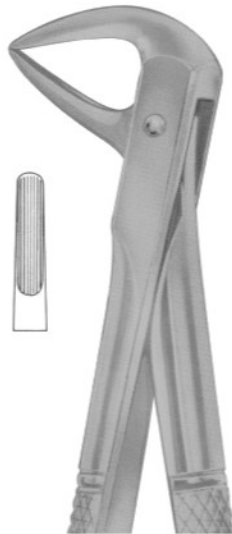

1100
Fig. 114
upper roots



1103
Fig. 143
lower roots



1104
MEAD (MD 1)
upper anteriors,
roots, incisors, canines

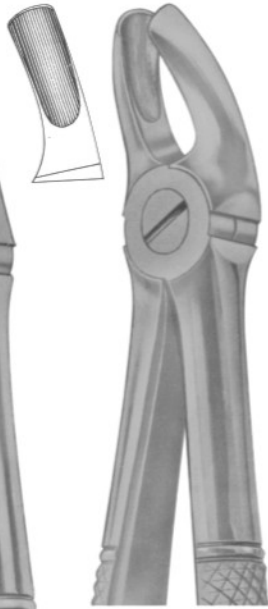

1105
MEAD (MD 2)
upper molars



1108
FELSCH (Fig. 211)
upper third molars

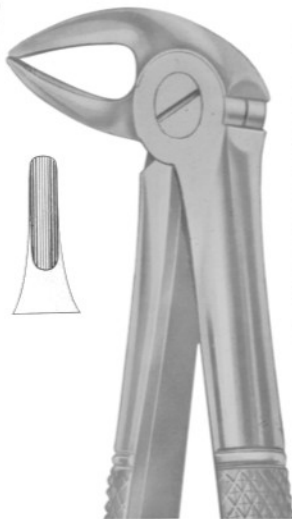

1106
MEAD (MD 3)
lower roots

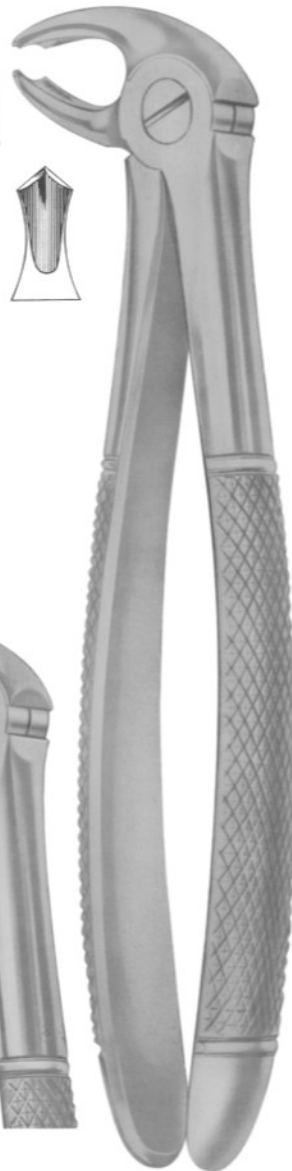

1107
MEAD (MD 4)
lower molars



1109
HERTZ (Fig. 211)
lower incisors

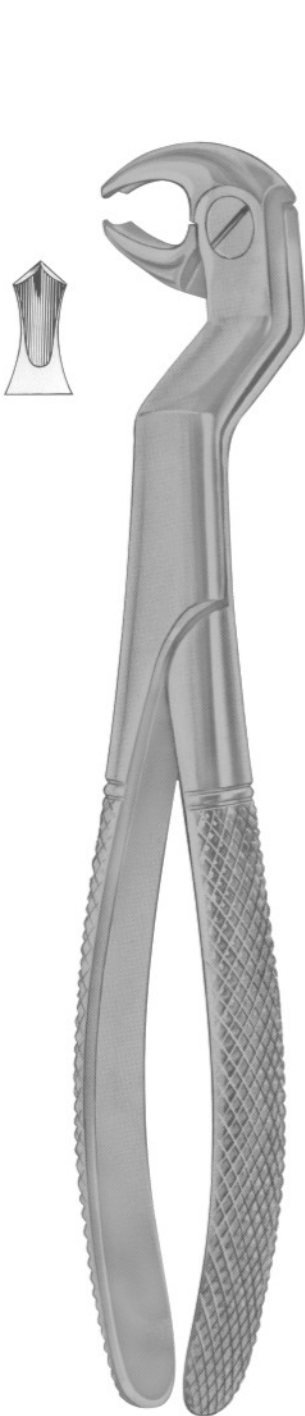

1110
ROUTURIER (Fig. 212)
(22 ½ L)
lower molars
and wisdom left

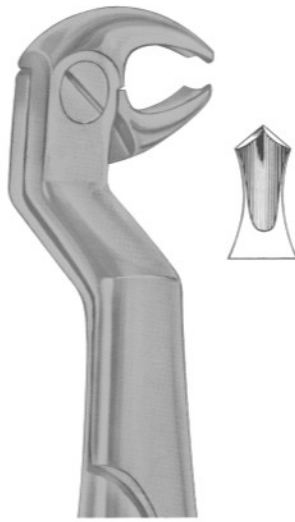

1111
ROUTURIER (Fig. 213)
(22 ½ R)
lower molars
and wisdom right

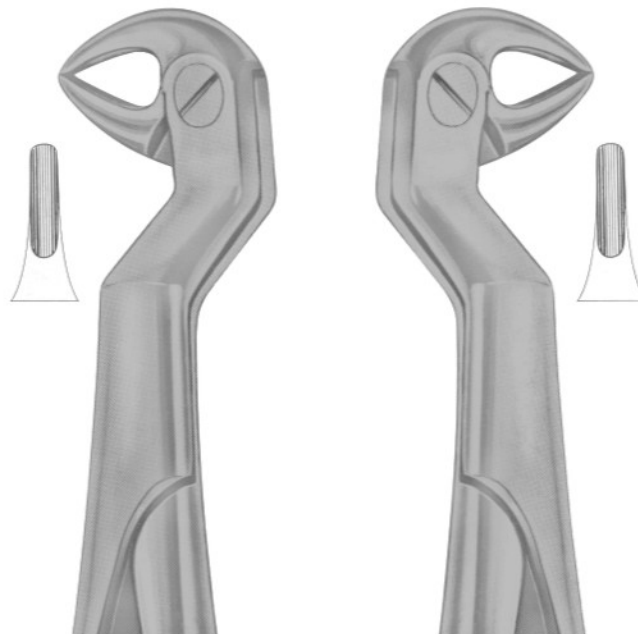

1112
ROUTURIER (Fig. 214)
(22 ½ L)
lower molars
and wisdom left

1113
ROUTURIER (Fig. 215)
(33 ½ R)
lower molars
and wisdom right

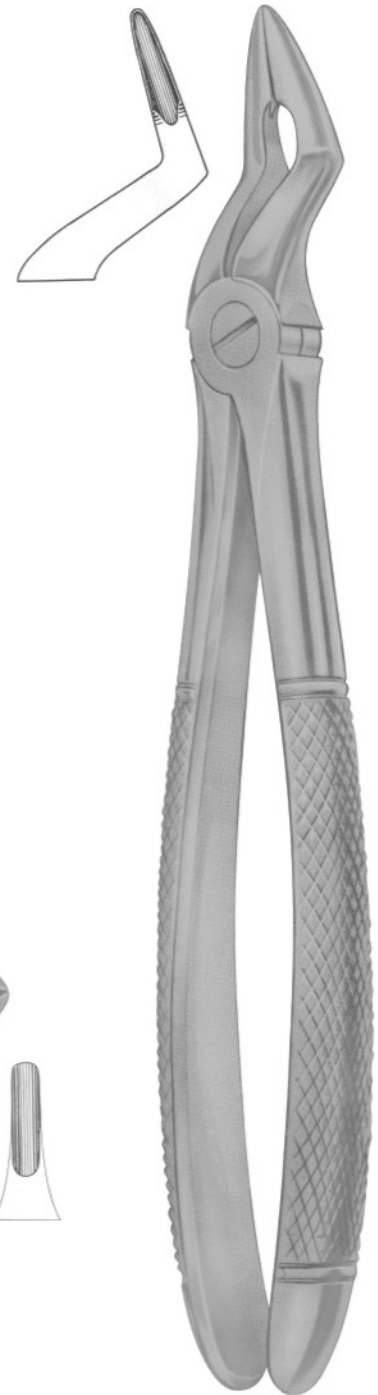

1114
RESECTION FORCEPS
(216/Witzel)
upper roots



1115
Fig. 5



1116
Fig. 6



1117
Fig. 9



1118
Fig. 10



1119
Fig. 11



1120
Fig. 12



1121
Fig. 14



1122
Fig. 15



1123
Fig. 25



1124
Fig. 26



1125
Fig. 27



1126
Fig. 28



1127
Fig. 34



1128
Fig. 35

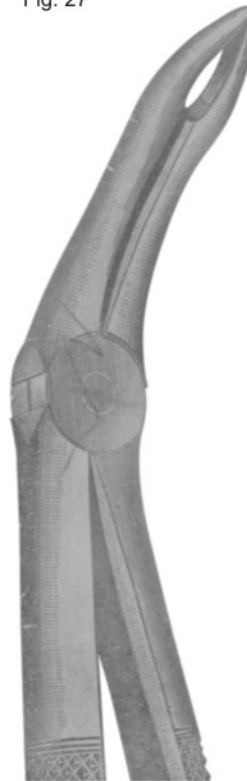

1129
Fig. 42



1130
Fig. 43



1131
Fig. 44A

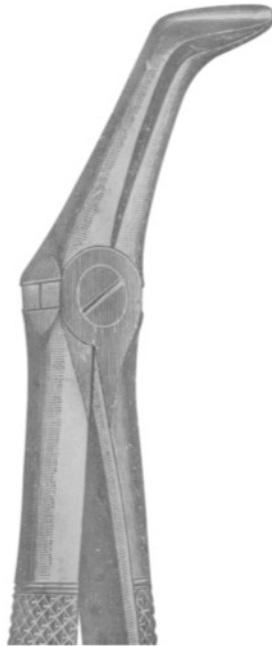

1132
Fig. 46



1133
Fig. 47



1134
Fig. 50A



1135
Fig. 74R



1136
Fig. 74L



1137
Fig. 75R



1138
Fig. 75L

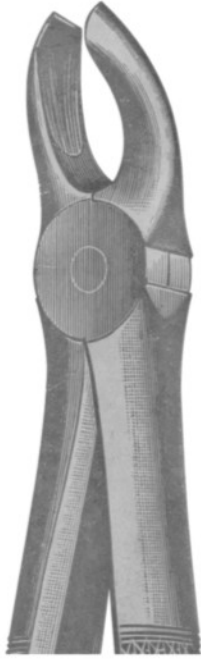

1139
Fig. 94



1140
Fig. 95



1141
Fig. 98



1142
Fig. 105



1143
Fig. 106



1144
Fig. 2002



1145
Fig. 1
upper laterals
and canines

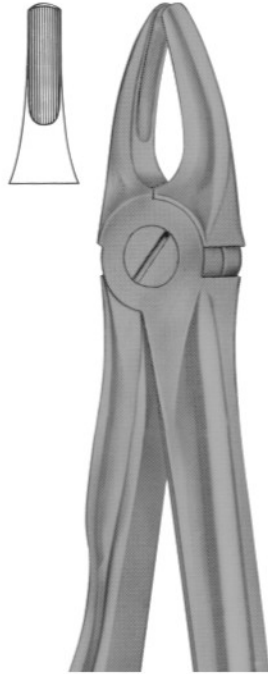

1146
Fig. 2
upper laterals
and canines

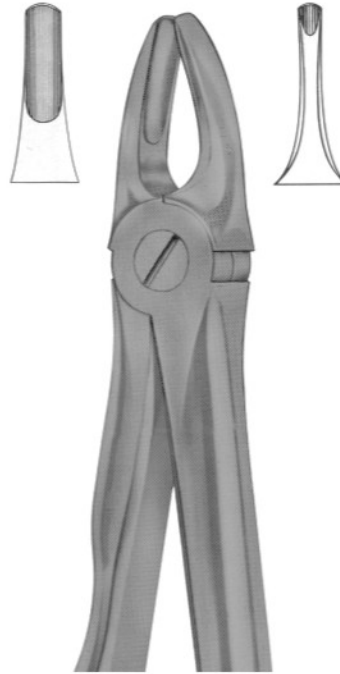

1147
Fig. 3
upper incisors
and canines

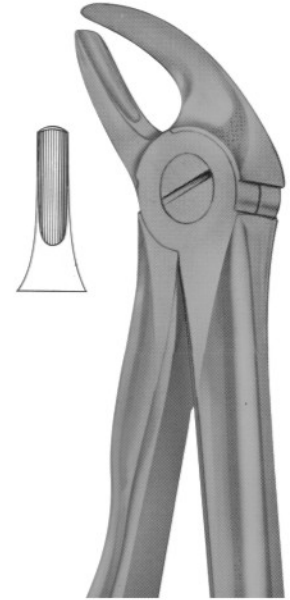

1148
Fig. 4
lower incisors
and canines

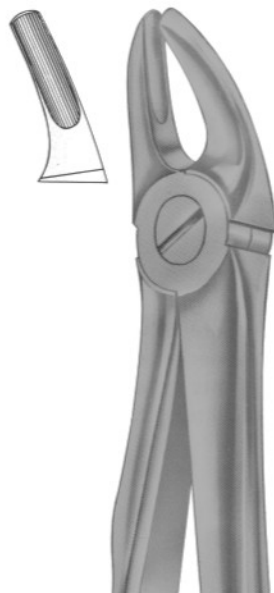

1149
Fig. 7
upper premolars

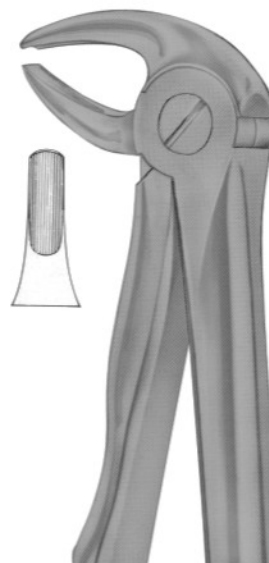

1150
Fig. 13
lower premolars



1151
Fig. 13S
lower premolars
for children



1152
Fig. 17
upper molars right

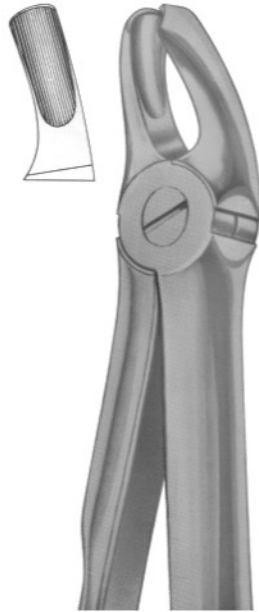

1153
Fig. 18
upper molars left

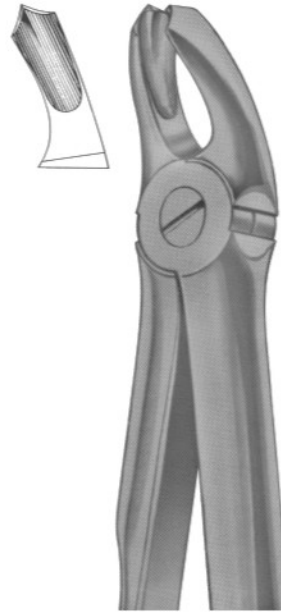

1154
Fig. 18A
upper molars

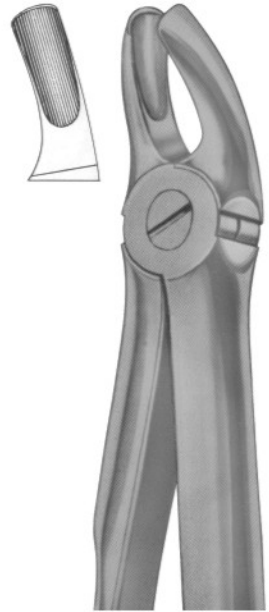

1155
Fig. 18B
upper molars

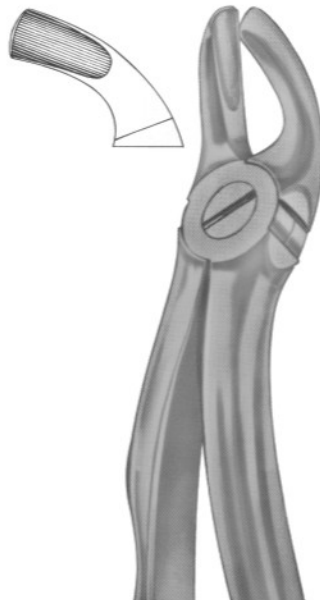

1156
Fig. 19
upper third molars

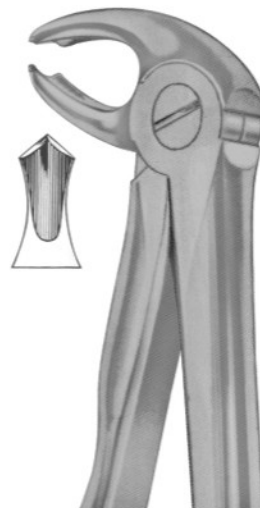

1157
Fig. 22
lower molars

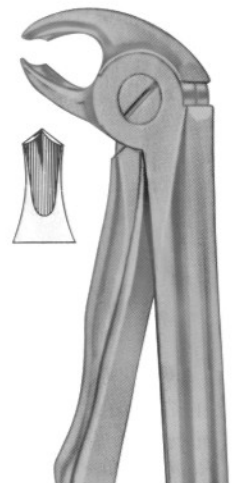

1158
Fig. 22S
lower molars
for children



1159
Fig. 29
upper roots

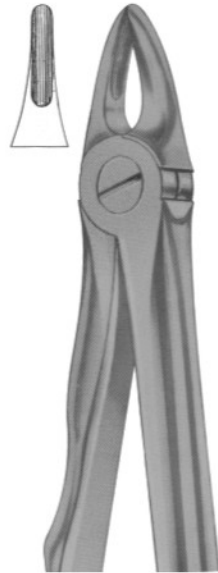

1160
Fig. 29S
upper roots
for children

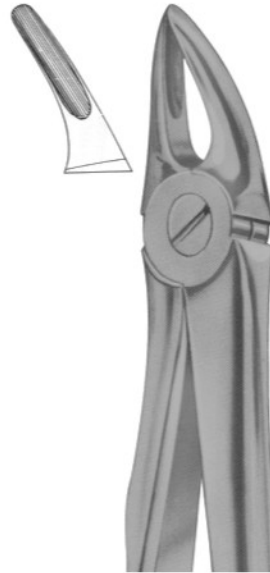

1161
Fig. 30
upper roots

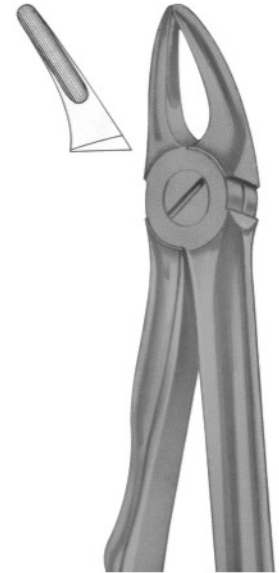

1162
Fig. 30S
upper roots
for children

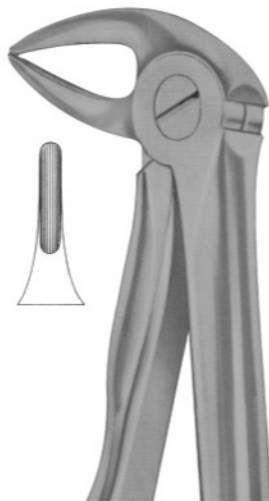

1163
Fig. 33
lower roots

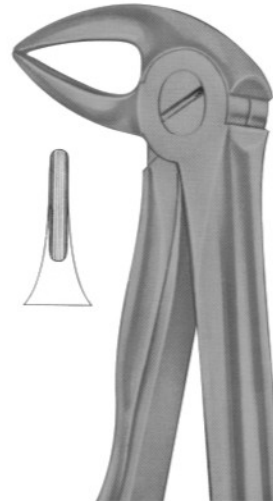

1164
Fig. 33A
lower roots

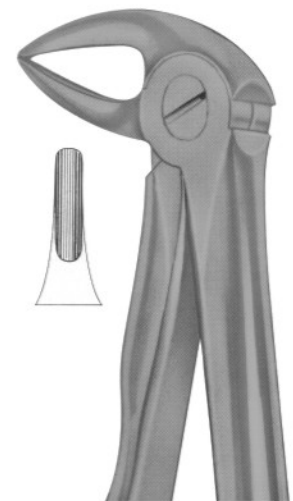

1165
Fig. 33B
lower roots



1166
Fig. 33L
lower roots

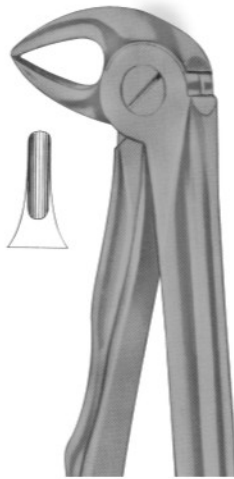

1167
Fig. 33S
lower roots
for children

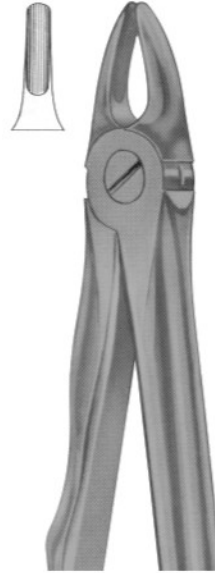

1168
Fig. 37
upper incisors
for children



1169
Fig. 39
upper incisors
for children



1170
Fig. 39A
upper molars
for children



1171
Fig. 39R
upper molars right
for children

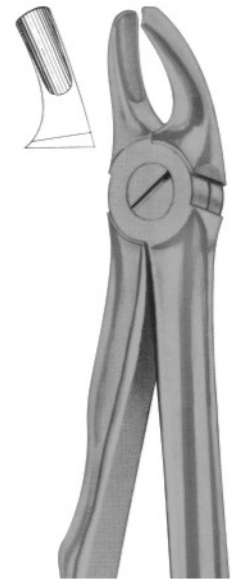

1172
Fig. 39L
upper molars left
for children

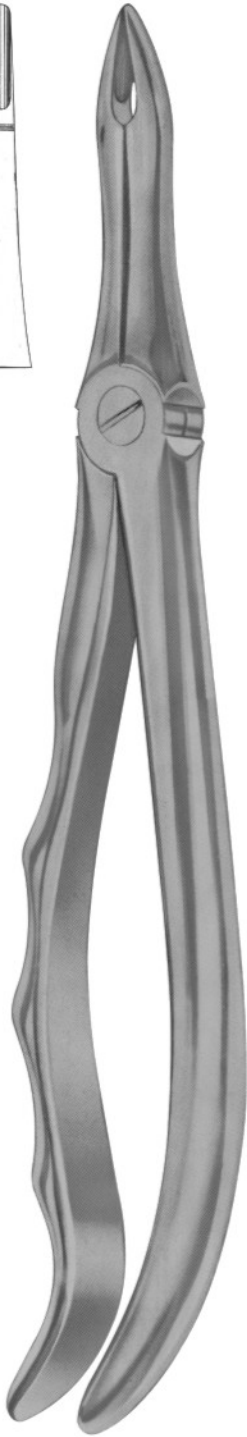

1173
Fig. 41
upper roots

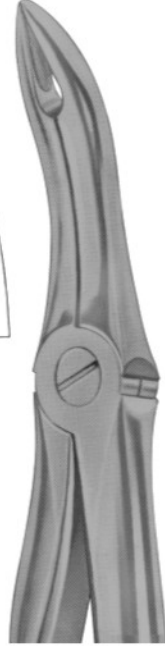

1174
Fig. 44
upper roots

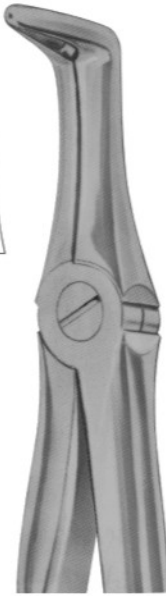

1175
Fig. 45
lower roots

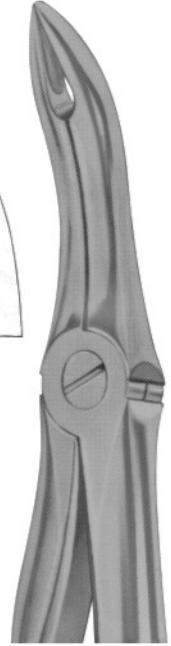

1176
Fig. 48
lower roots

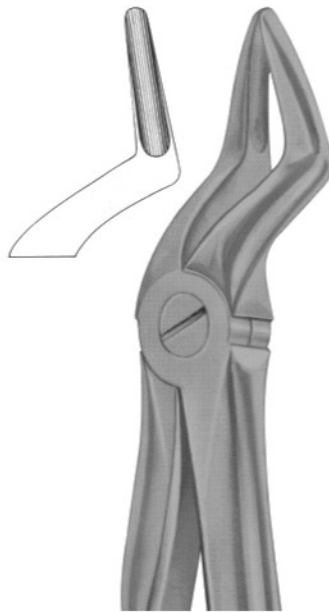

1177
Fig. 51
upper roots

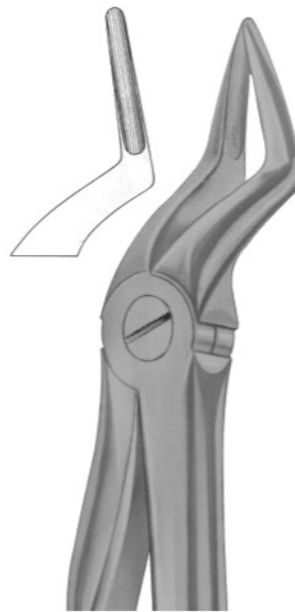

1178
Fig. 51A
upper roots

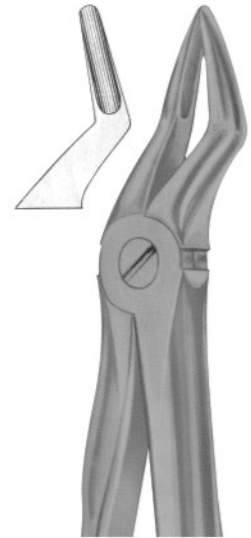

1179
Fig. 51S
upper roots
for children

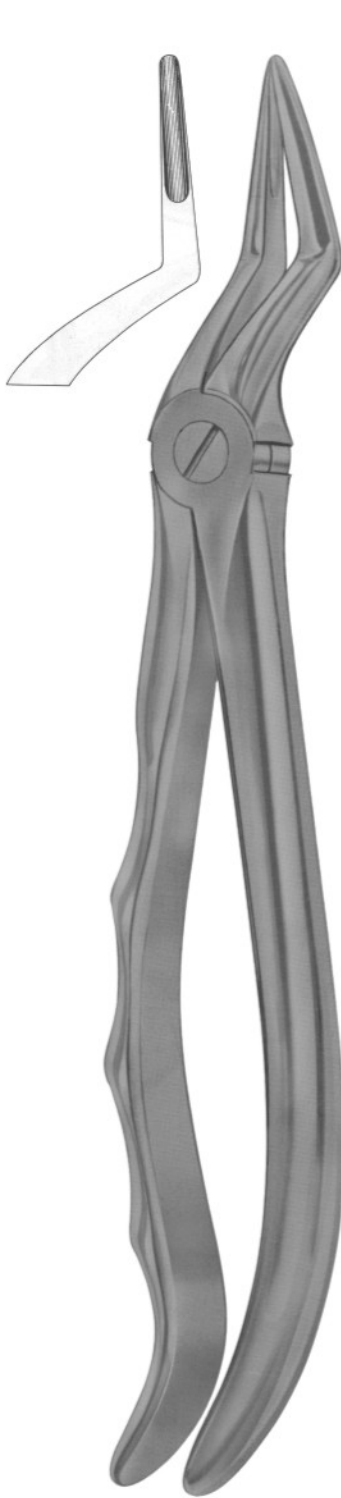

1180
Fig. 51L
upper roots

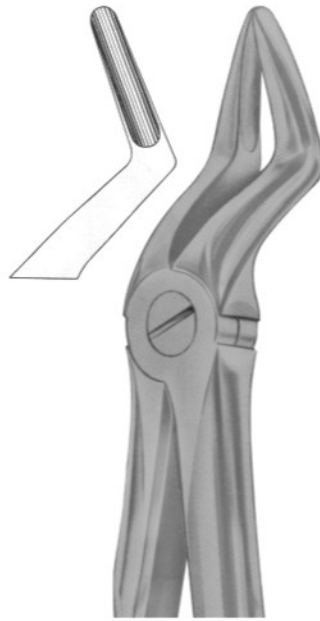

1181
Fig. 52
upper roots

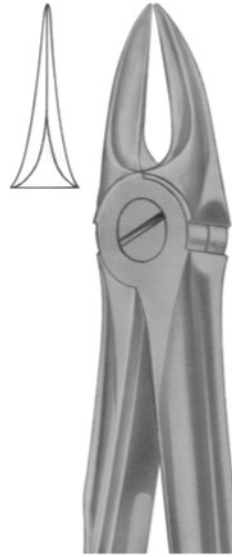

1182
Fig. 54
for separating
upper molars

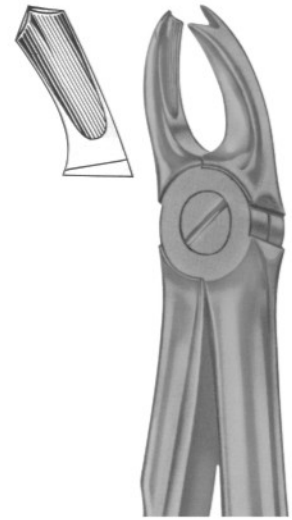

1183
Fig. 65R
upper molars right

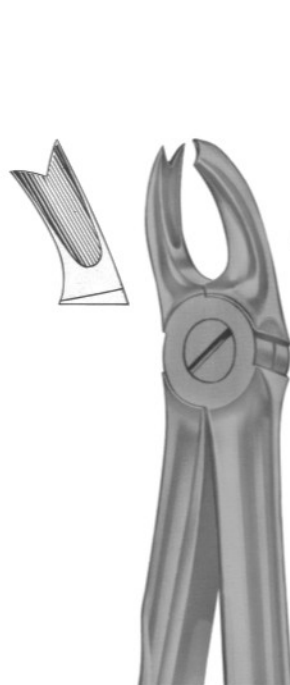

1184
Fig. 65L
upper molars left



1185
Fig. 67
upper third molars

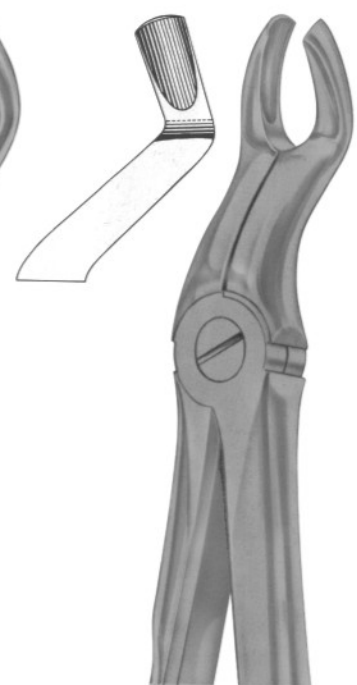

1186
Fig. 67A
upper third molars



1187
Fig. 67 ½ R
upper third molars
right

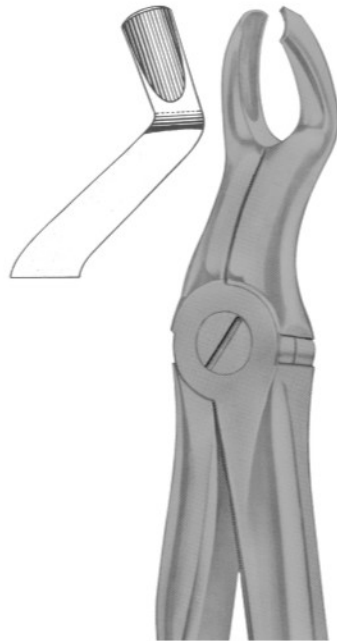

1188
Fig. 67 ½ L
upper third molars
left



1189
Fig. 73
lower molars

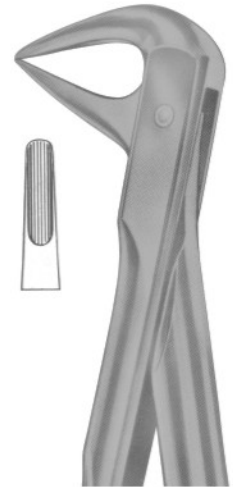

1190
Fig. 74
lower roots

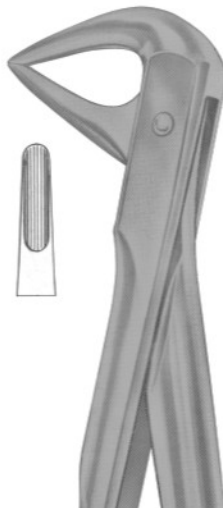

1191
Fig. 74M
lower roots



1192
Fig. 74N
lower roots



1193
Fig. 74XN
lower roots and
crowded incisors



1194
Fig. 75
lower premolars



1195
Fig. 76
upper roots



1196
Fig. 76N
upper roots

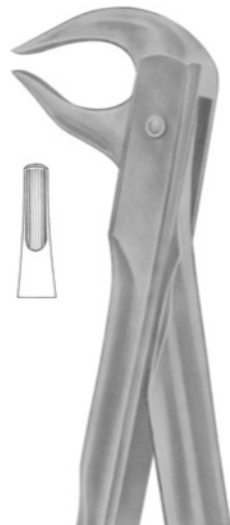

1197
Fig. 81
lower premolars
and roots



1198
Fig. 76A
lower third molars



1199
Fig. 79
lower third molars



1200
Fig. 86A
lower molars



1201
Fig. 86B
lower molars



1202
Fig. 86C
lower molars



1203
Fig. 99
lower molars



1204
Fig. 99 1/4
lower molars

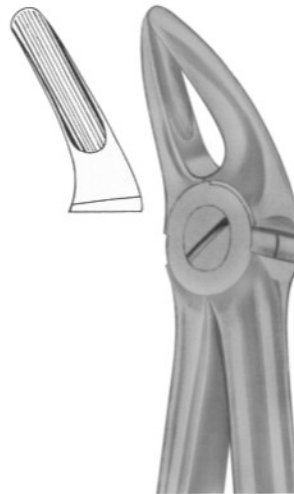

1205
Fig. 136
upper premolars
and roots



1206
Fig. 143
lower roots



1207
KLEIN (Fig. 217)
upper incisors



1208
KLEIN (Fig. 218)
upper premolars

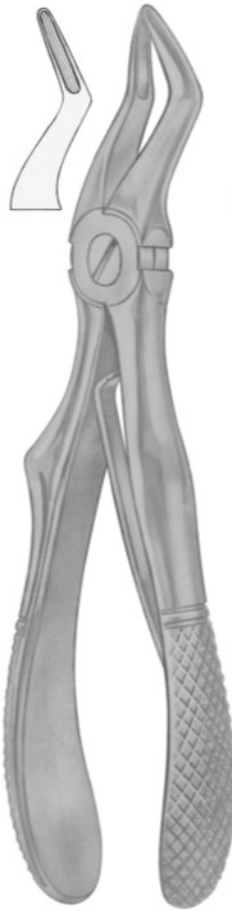

1209
KLEIN (Fig. 219)
upper roots

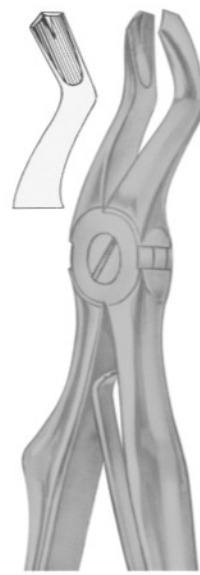

1210
KLEIN (Fig. 220)
upper molars



1214
ALBRECHT
Fig. 224
Deciduous

1215
ALBRECHT
Fig. 225
Deciduous



1211
KLEIN (Fig. 221)
lower incisors



1212
KLEIN (Fig. 222)
lower molars



1213
KLEIN (Fig. 223)
lower roots

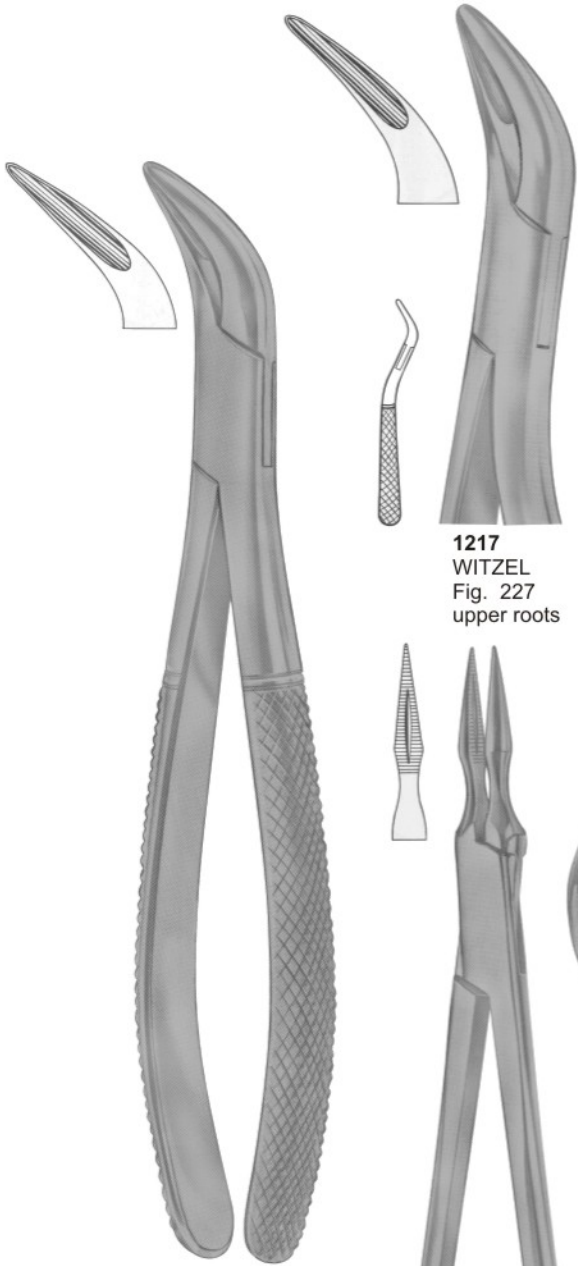

1216
WITZEL
Fig. 226
lower roots

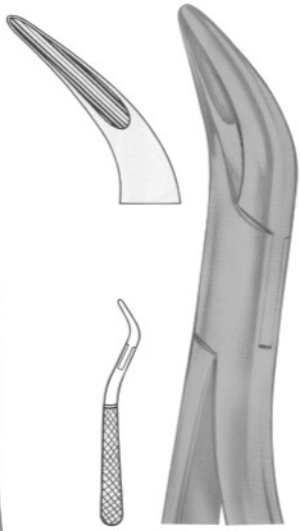

1217
WITZEL
Fig. 227
upper roots

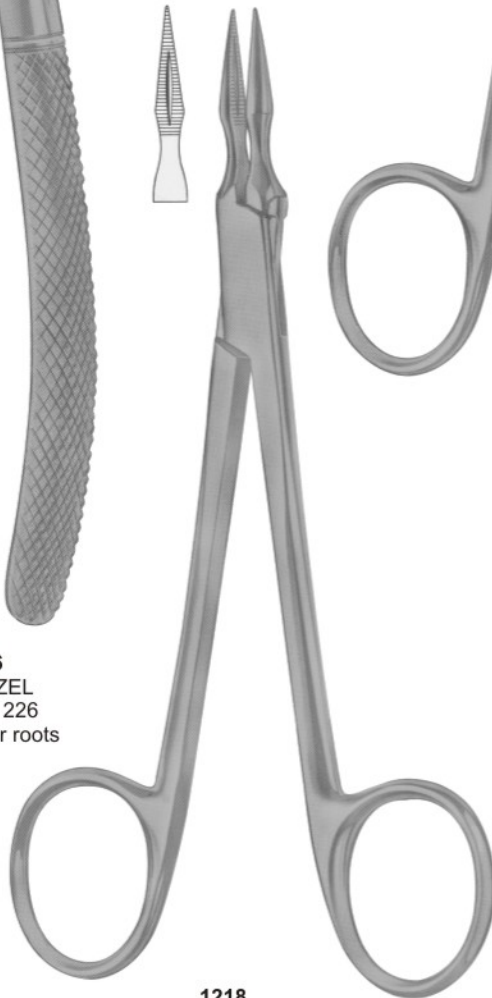

1218
ARTHUR
Fig. 228
root fragments



1219
STIEGLITZ
Fig. 229
root fragments

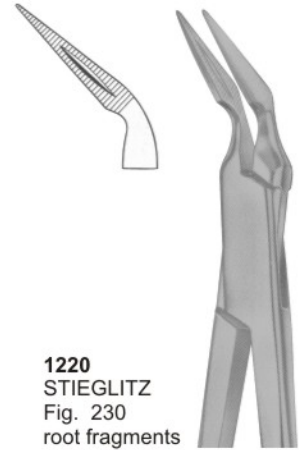

1220
STIEGLITZ
Fig. 230
root fragments



1221
RALK
Fig. 231
root fragments



1222
W1-WINTER
upper centrals
and canines

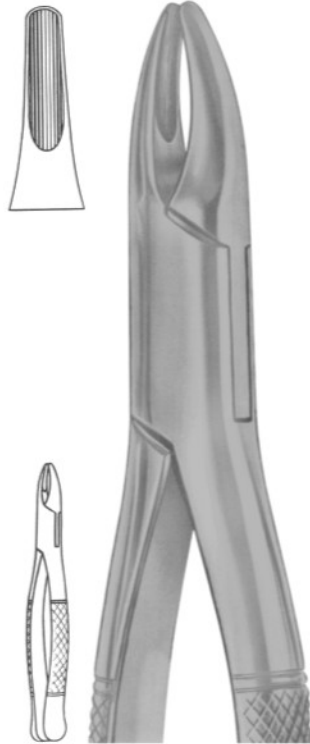

1223
Fig. 1
upper incisors and roots

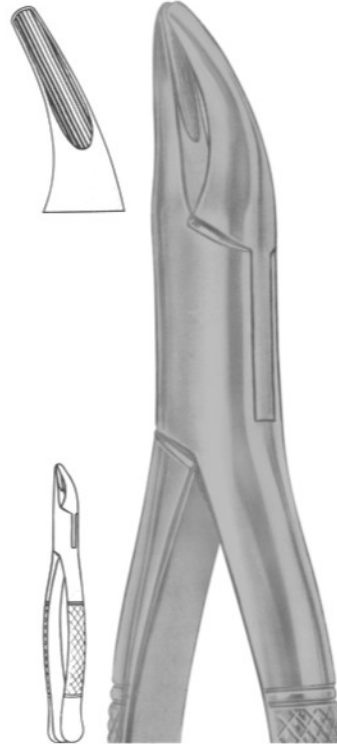

1224
Fig. 2
upper and lower roots

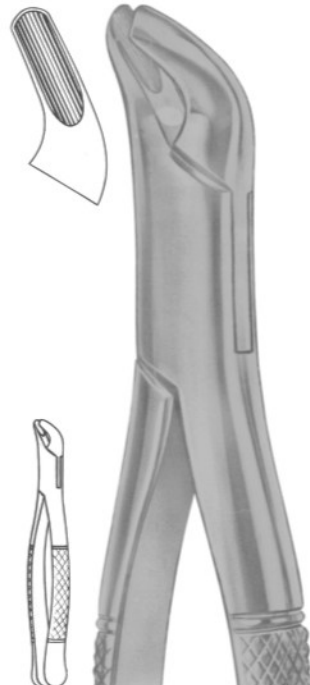

1225
Fig. 4
upper and lower premolars

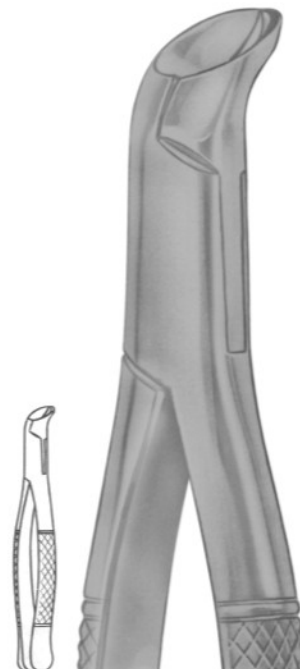

1226
PHYSICK
Fig. 5
lower third molars

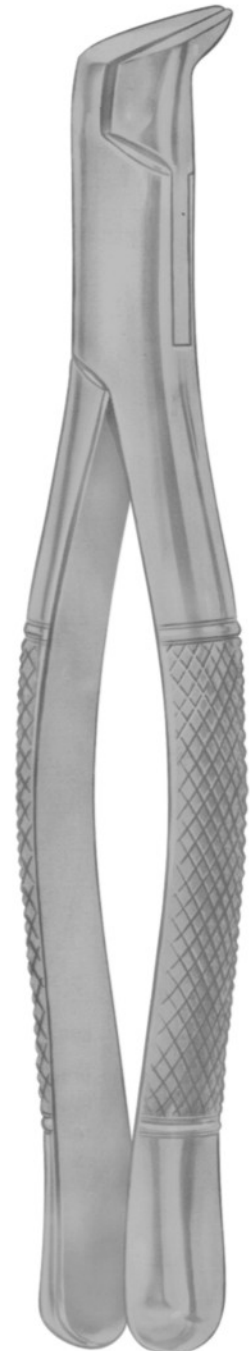

1227
Fig. 6
separating
forceps



1228
Fig. 7
upper roots

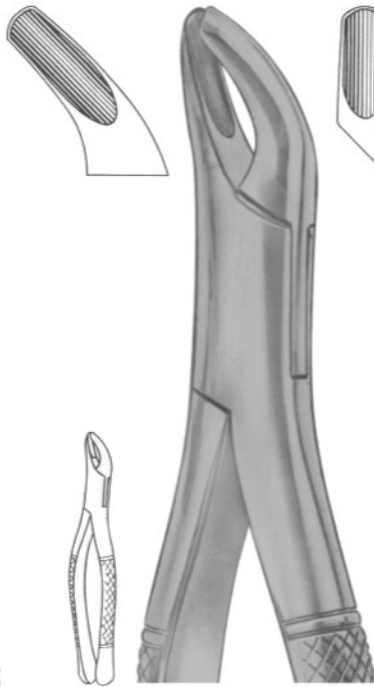

1229
Fig. 8
upper and lower
third molars



1231
Fig. 10H
upper molars

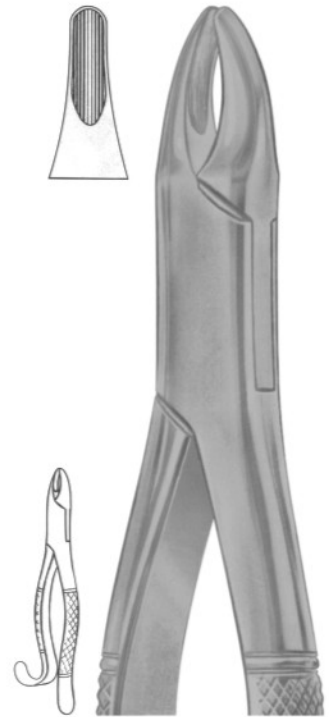

1232
Fig. 13
upper incisors

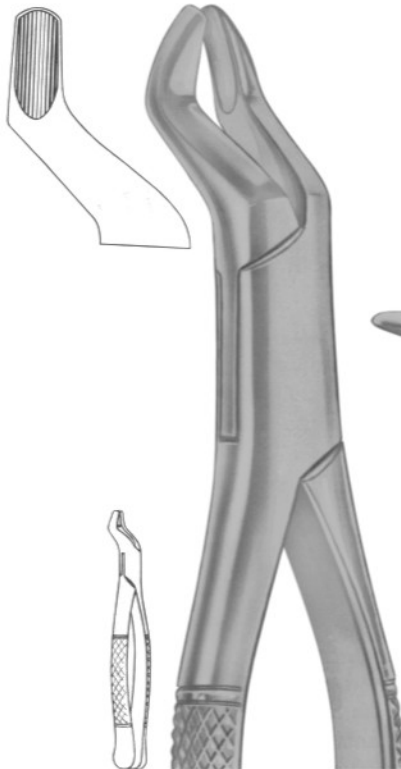

1230
Fig. 10S
upper molars

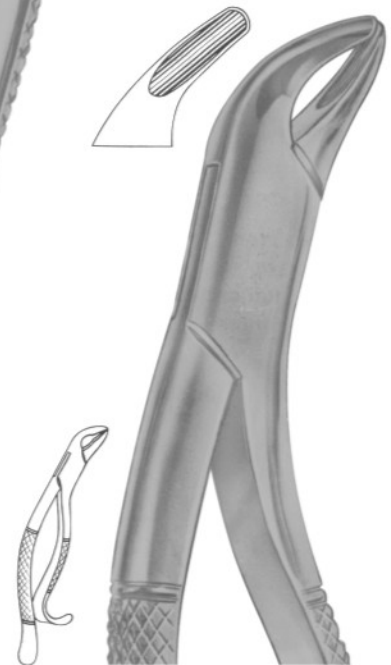

1233
Fig. 14
lower incisors

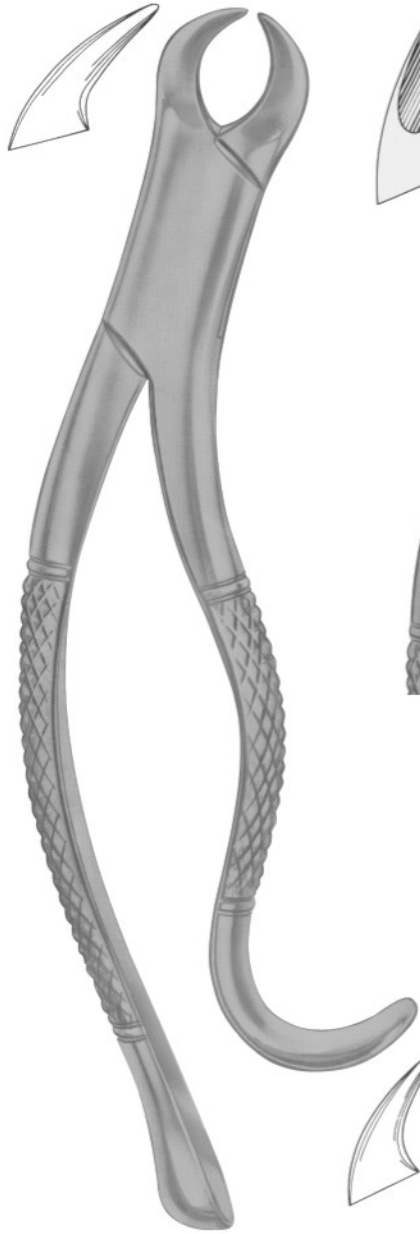

1234
Fig. 16
lower molars

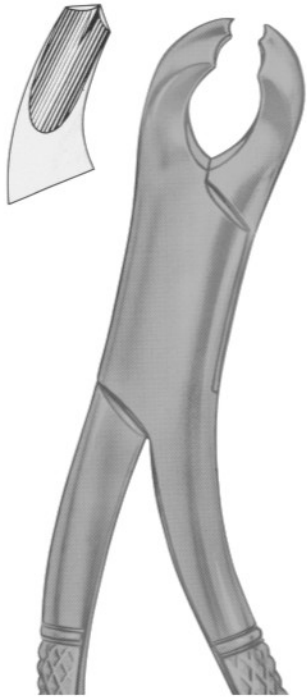

1235
HARRIS
Fig. 15
lower molars

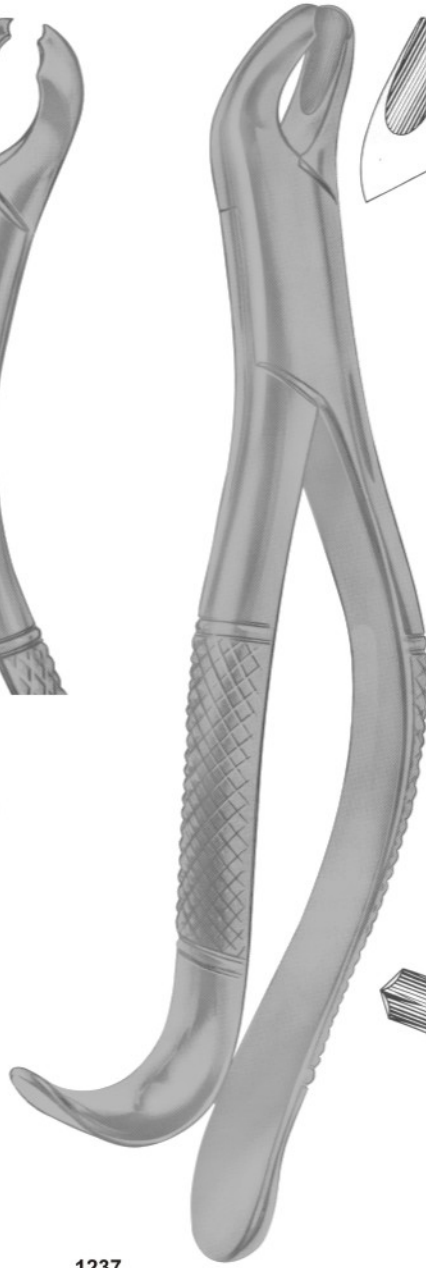

1237
HARRIS
Fig. 18R
upper molars right



1238
HARRIS
Fig. 18L
upper molars left



1236
Fig. 16S
lower molars
for children

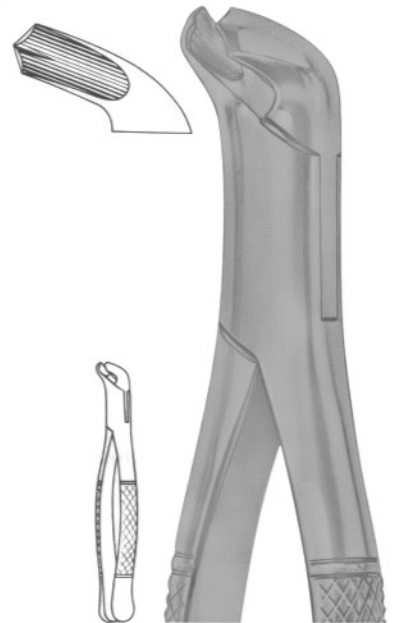

1239
Fig. 17
lower molars



1240
Fig. 20R
upper molars right



1241
Fig. 20L
upper molars left



1242
Fig. 23
lower molars



1245
Fig. 29S
lower teeth
for children

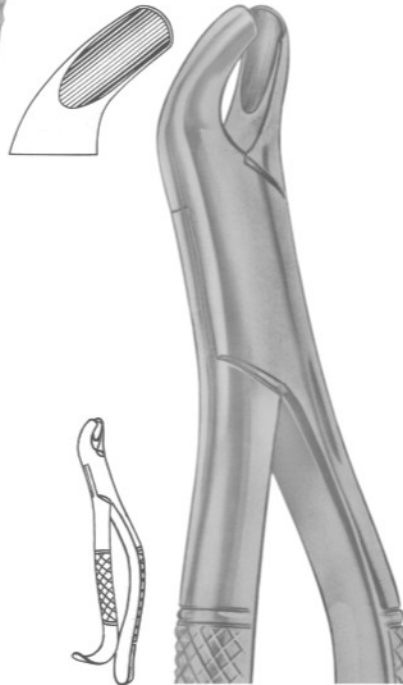

1243
Fig. 24
upper molars

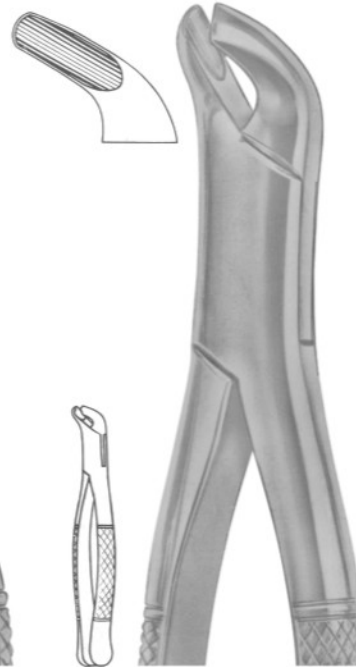

1244
Fig. 27
lower molars

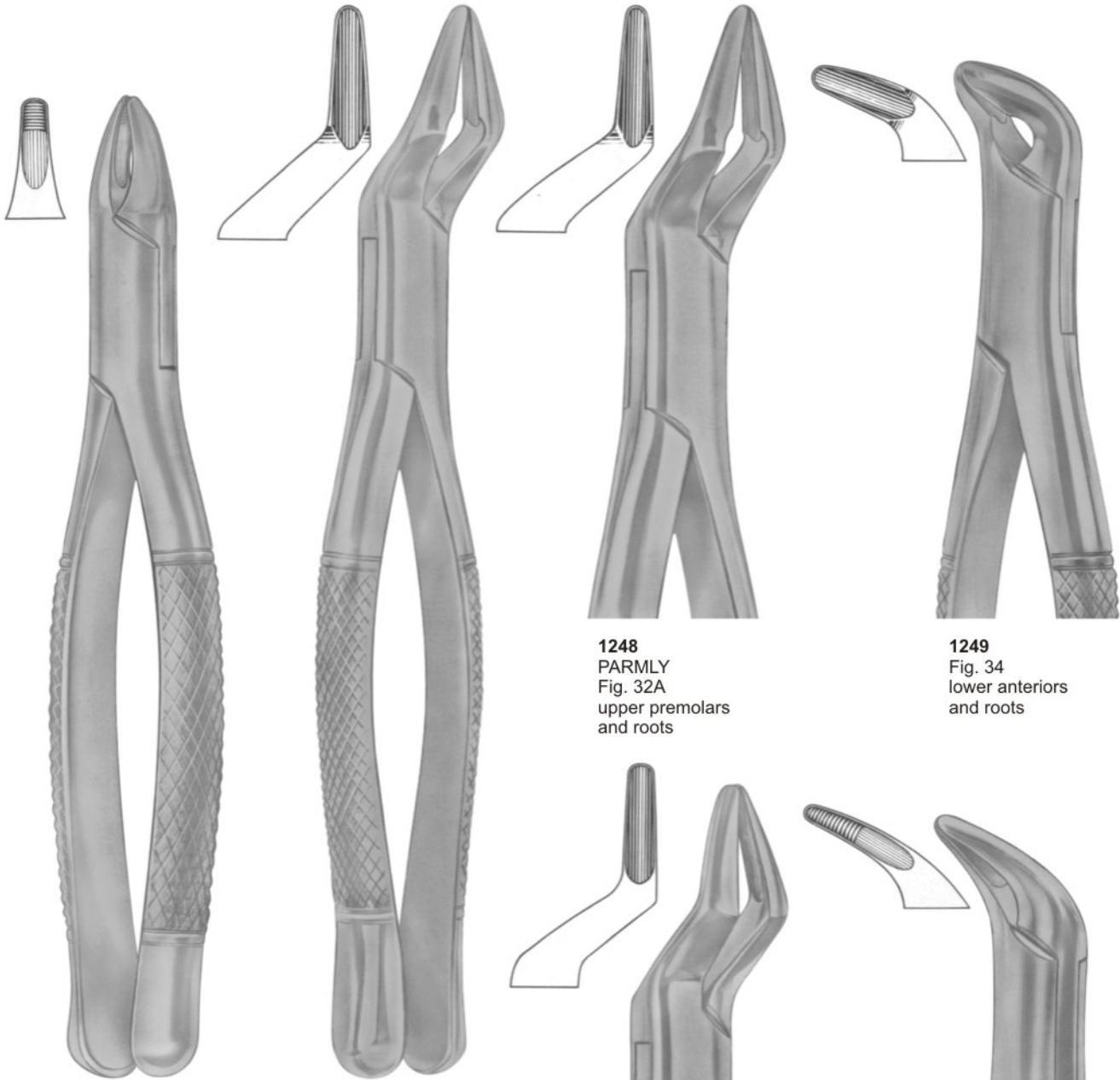

1246
Fig. 30S
upper teeth
for children

1247
PARMLY
Fig. 32
upper premolars
and molars

1248
PARMLY
Fig. 32A
upper premolars
and roots

1249
Fig. 34
lower anteriors
and roots

1250
Fig. 35
upper roots

1251
Fig. 36
lower anteriors
and roots



1252
Fig. 37
lower anteriors
and roots

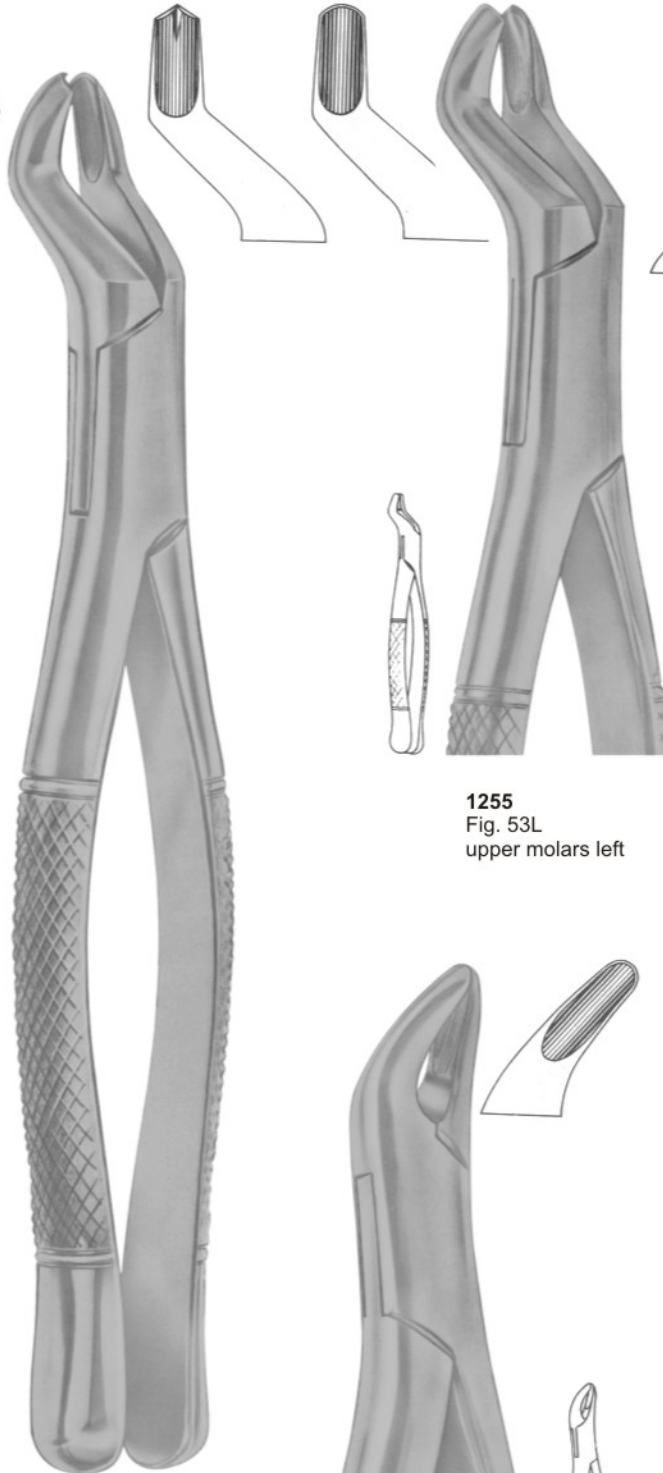

1254
Fig. 53R
upper molars right



1255
Fig. 53L
upper molars left

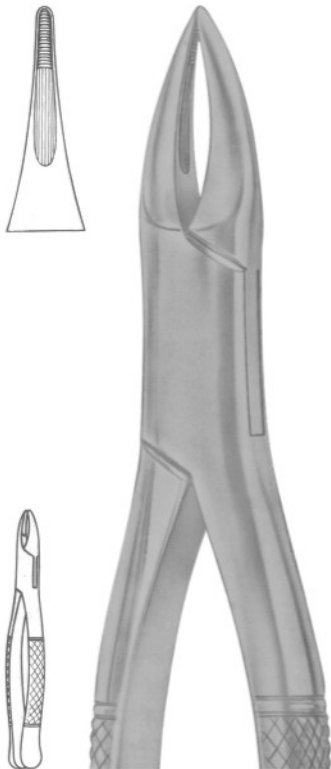

1253
Fig. 38
upper anteriors
and roots

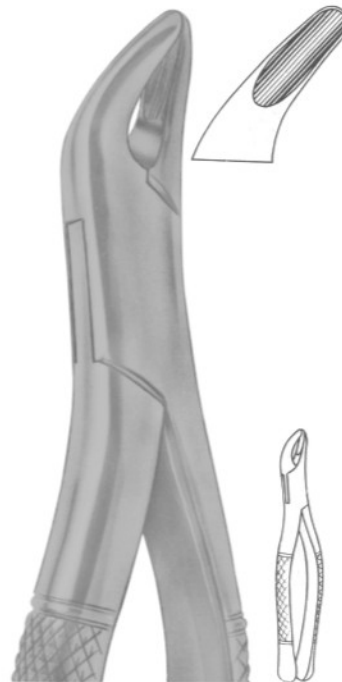

1256
Fig. 62
incisors, premolars,
deciduous teeth

1257
Fig. 65
upper incisors
and roots

Extracting Forceps "American Pattern"



1258
TOMES
Fig. 69
upper and lower roots



1259
TOMES
Fig. 85
lower canines,
premolars and molars

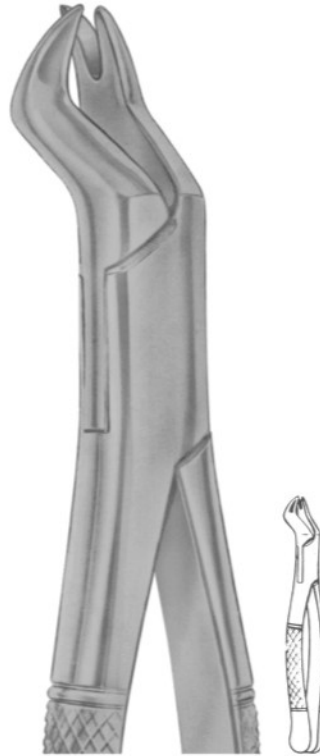

1260
NEVIUS
Fig. 88R
upper molars right

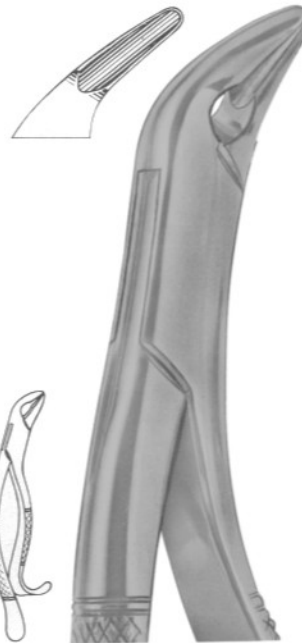

1261
THOMAS
Fig. 85A
lower canines,
premolars and molars



1262
NEVIUS
Fig. 88L
upper molars left



1263
KELLS
Fig. 99A
upper incisors,
canines, premolars

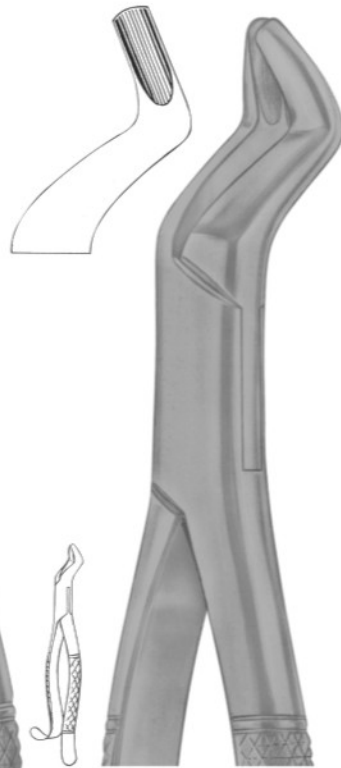

1264
Fig. 104
upper third molars



1266
HULL
Fig. 101
deciduous teeth



1267
Fig. 103
lower incisors,
premolars



1265
KELLS
Fig. 99C
upper incisors,
canines, premolars

Extracting Forceps "American Pattern"

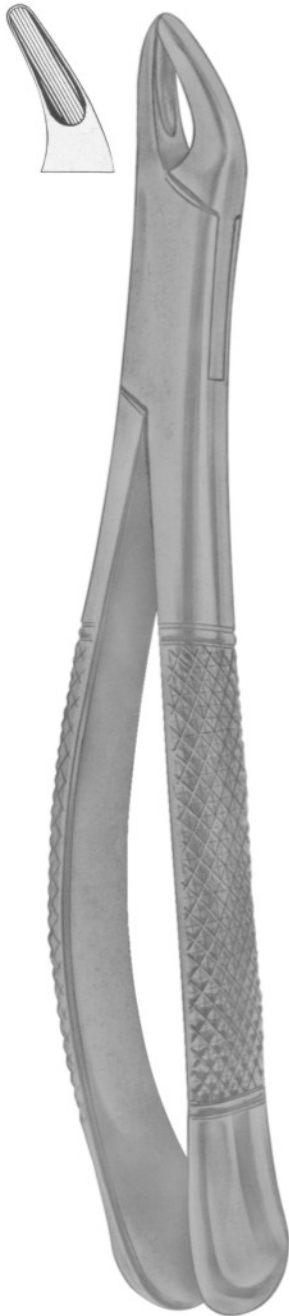

1268
CRYER
Fig. 150
lower incisors,
premolars, roots



1269
CRYER
Fig. 150A
upper incisors,
premolars, roots

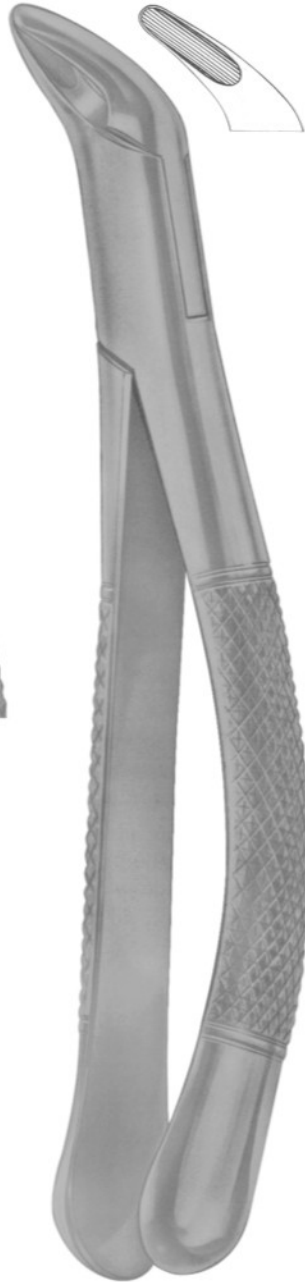

1271
CRYER
Fig. 151
lower incisors,
premolars, roots



1272
CRYER
Fig. 151A
lower incisors,
premolars, roots

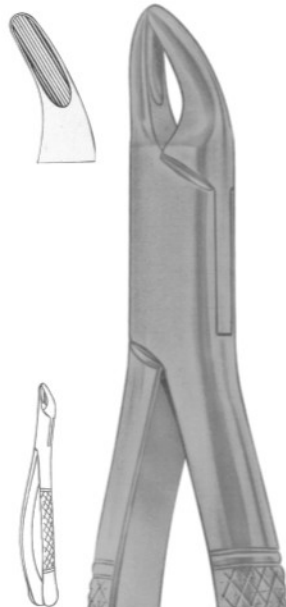

1270
CRYER
Fig. 150S
upper teeth for children

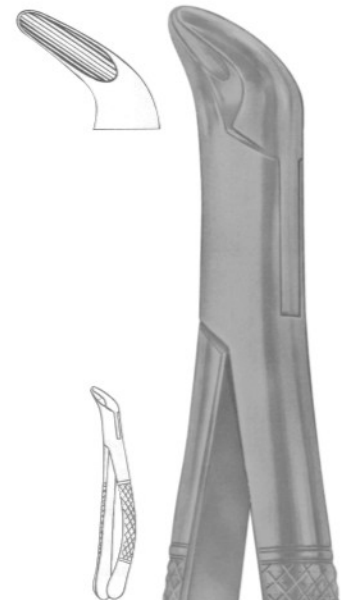

1273
CRYER
Fig. 151S
lower teeth
for children



1274
Fig. 203
lower incisors
and roots

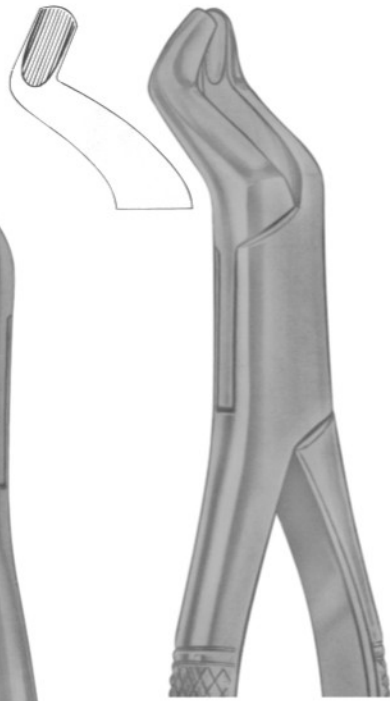

1275
Fig. 210S
upper third molars

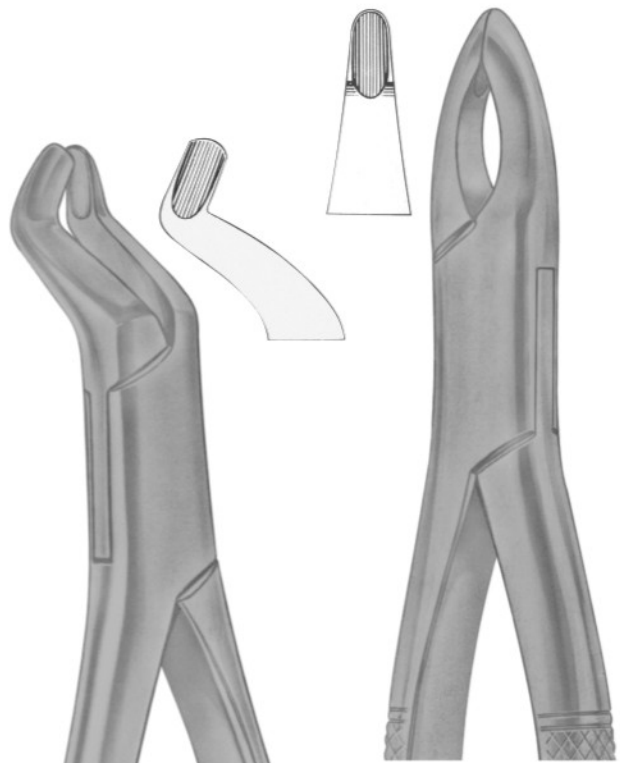

1278
Fig. 213
upper centrals and canines

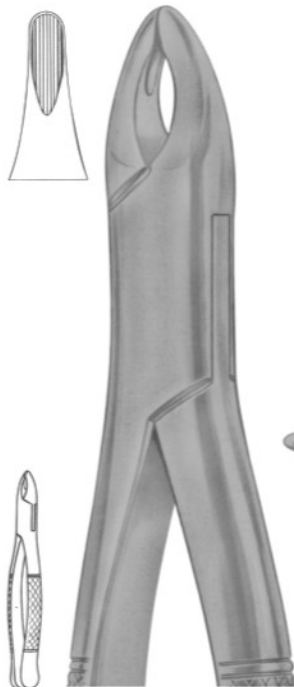

1276
Fig. 201
upper incisors,
canines, premolars



1277
Fig. 210H
upper third molars

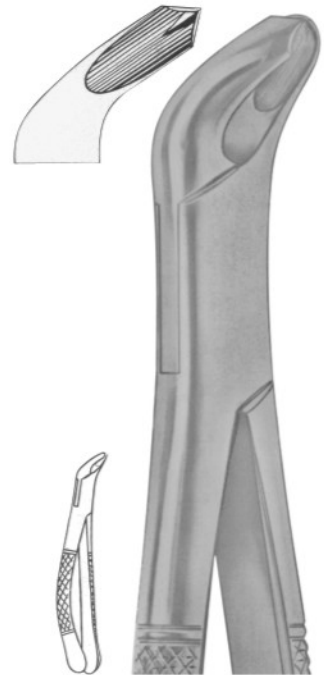

1279
Fig. 217
lower molars

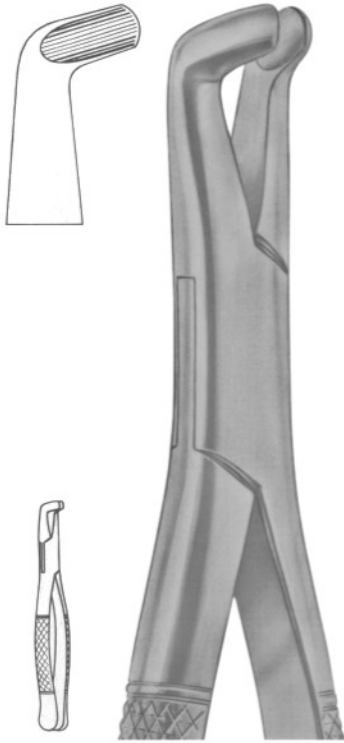

1280
Fig. 222
lower third molars



1282
Fig. 286
Swing lower molars



1283
Fig. 288
lower canines
and premolars

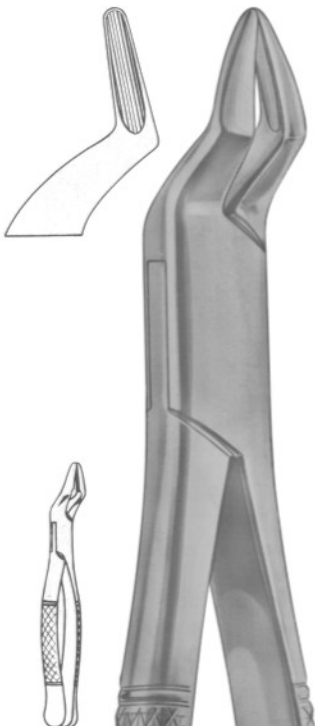

1281
Fig. 286
upper incisors and roots



1284
COHEN
Fig. 310
universal forceps

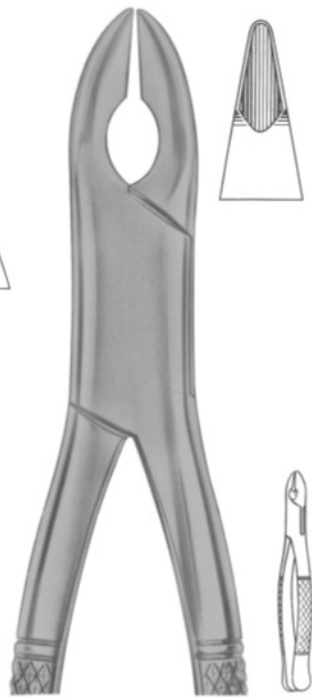

1285
NEVIUS
Fig. 320/10S
upper canines

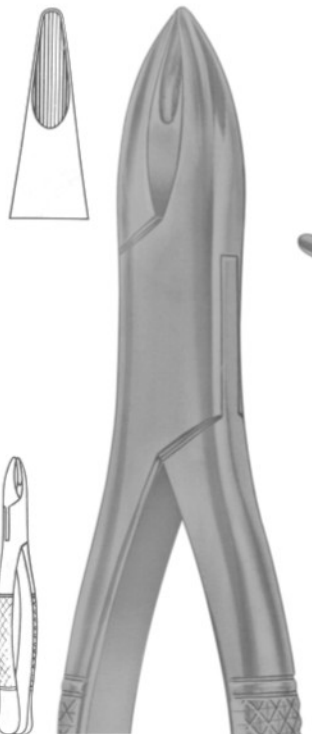

1286
HENAHAN
Fig. 315/1A
upper incisors

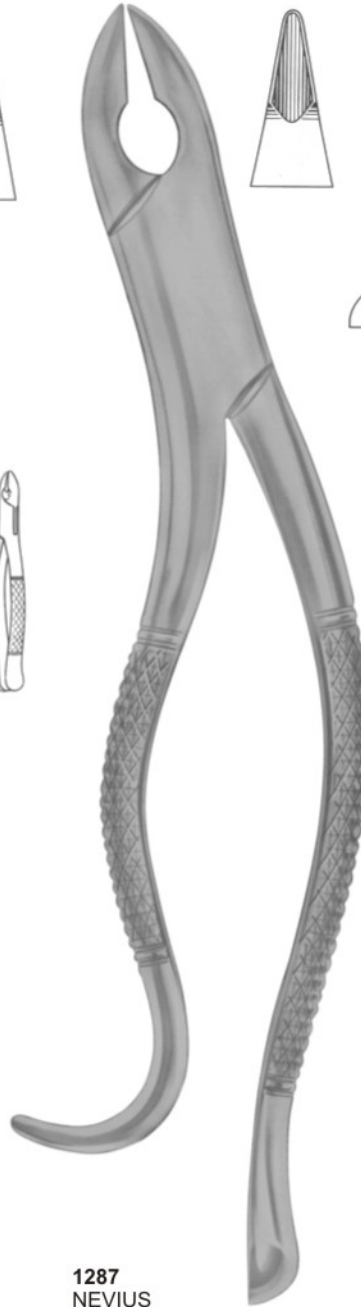

1287
NEVIUS
Fig. 325/10H
upper canines

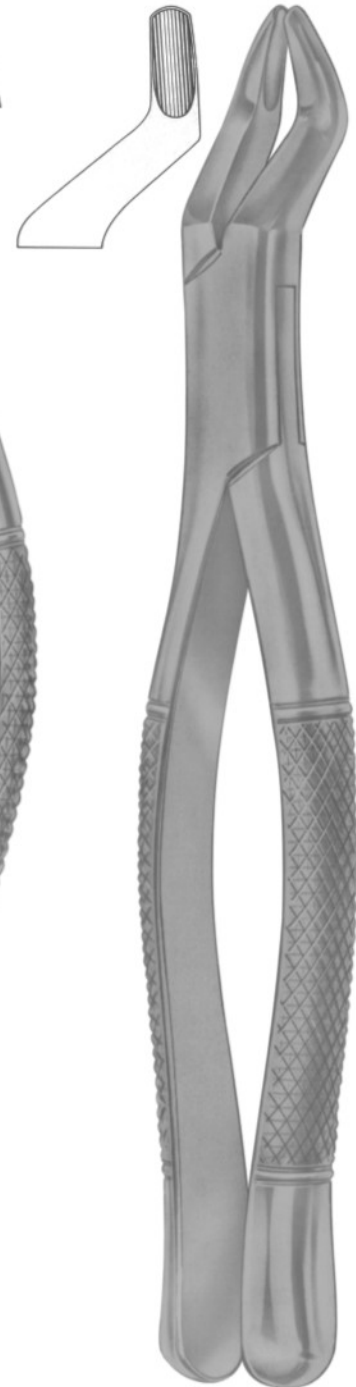

1288
STANDARD
Fig. 330/4
upper third molars



1289
WOODWARD
Fig. 335/FH
lower molars

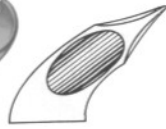

1290
Fig. 340/89
upper molars right

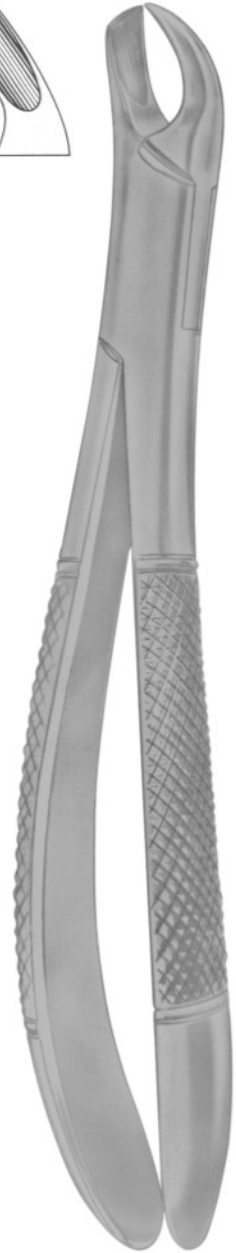

1292
Fig. 345/90
upper molars left

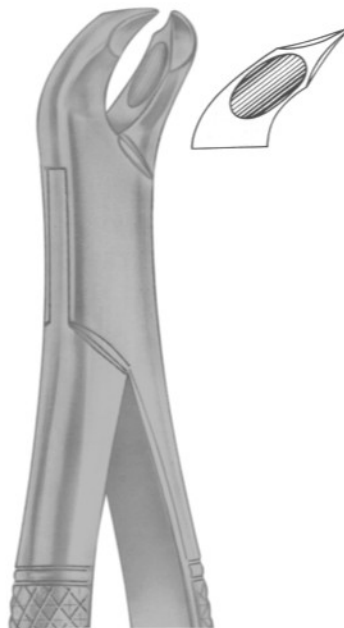

1291
WOODWARD
Fig. 335/FS
lower molars



1293
Fig. 350/23S
lower molars

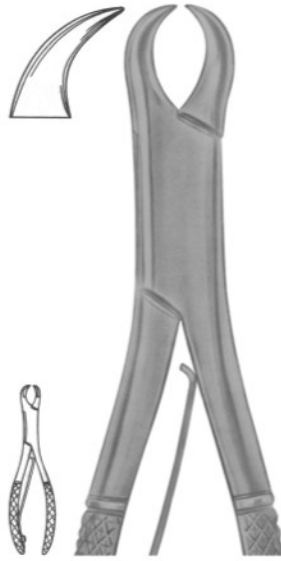

1294
Fig. 355/23SK
lower molars



1295
Forcep Fig. 301



1295-A
Forcep Fig. 300



1296
Fig. 360/17SK
lower molars



1297
Fig. 365/150SK
upper anteriors
and roots



1298
Fig. 370/151SK
lower anteriors
and roots



Peristeel Elevators



1299
Molt 9



1300
Allen 9A



1301
Prichard



1302
Seldin

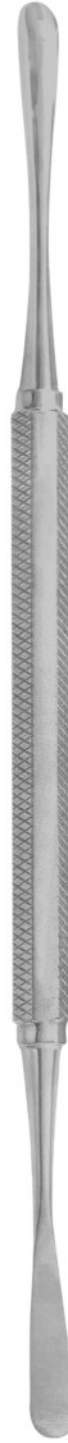

1303
Goldman- Fox 14

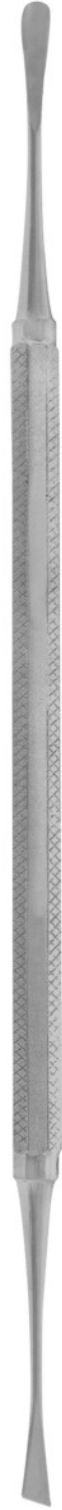

1304
West
Dell W2

Heidbrink Root - Tip Picks

Root Tip



1305
DEL 78



1306
DEL 79



1307
DEL 80



1308
DEL H1



1309
DEL H2



1310
DEL H3

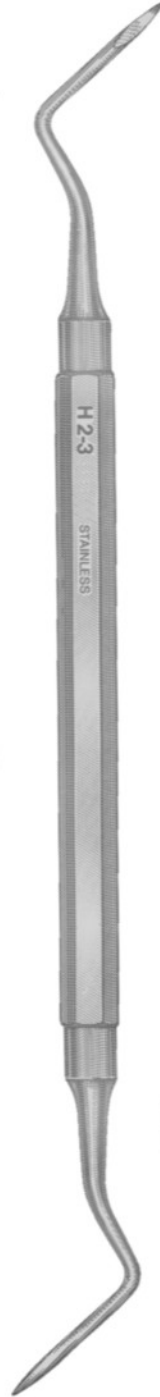

1311
DEL H2-3



1312
POTT
6X



1313
POTT
7X



1314
BUSER



1315
OHI 10



1316
HOWARD 9H



1317
FREER



1318
FREER 15



1319
FREER 16

lower jaw, left side

lower jaw, right side



1320
BEIN
Fig. 4



1331



1332

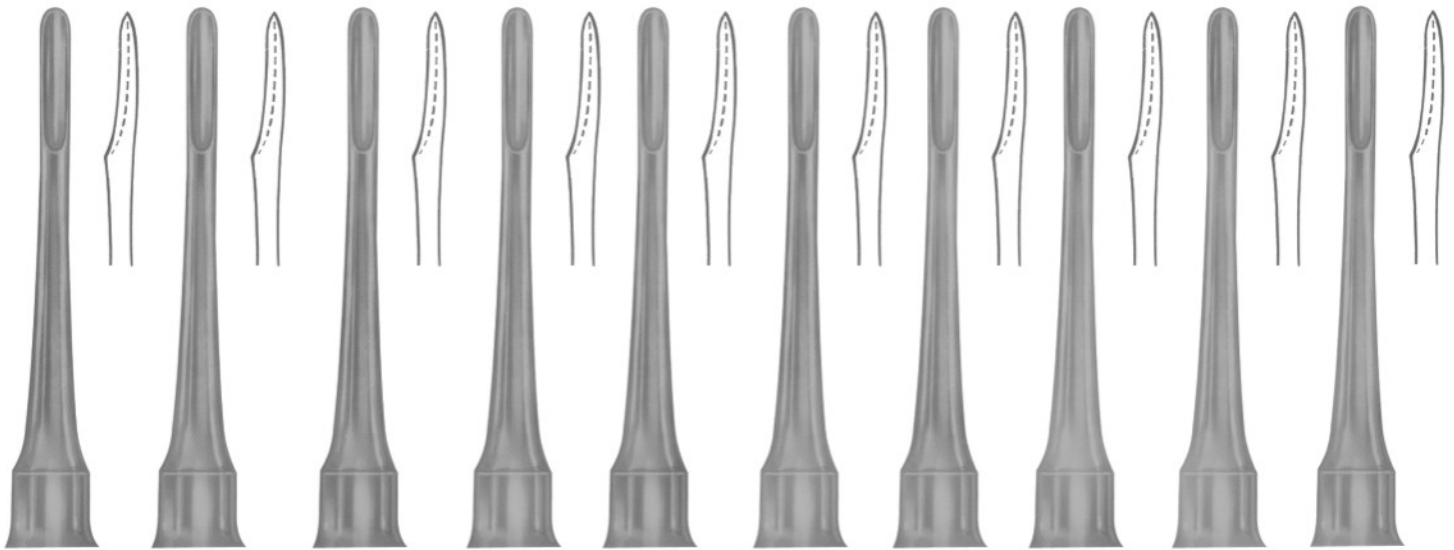

1321
BEIN
1.0 mm

1322
BEIN
1.5 mm

1323
BEIN
2.0 mm

1324
BEIN
2.5 mm

1325
BEIN
3.0 mm

1326
BEIN
3.5 mm

1327
BEIN
4.0 mm

1328
BEIN
4.5 mm

1329
BEIN
5.0 mm

1330
BEIN
5.5 mm

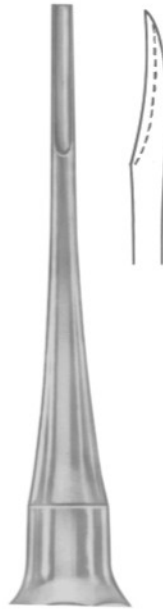

1334
BEIN
Fig. 1



1335
BEIN
Fig. 2

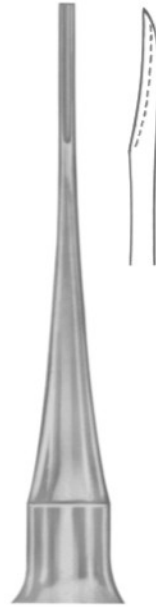

1336
BEIN
Fig. 0



1337
BEIN
Fig. 3



1333
BEIN

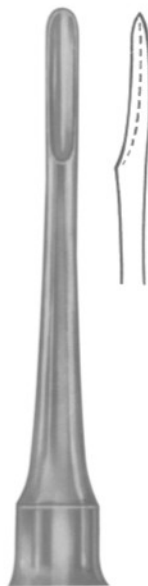

1338
BEIN
Fig. 4



1339
BEIN
Fig. 5



1340
BEIN
Fig. 6



1341
CRYER
Fig. 3



1342
CRYER
Fig. 4



1343
CRYER
Fig. 12



1344
CRYER
Fig. 27



1345
CRYER
Fig. 28



1346
CRYER
Fig. 27S



1347
CRYER
Fig. 28S



1348
SELDIN
Fig. 2



1349
SELDIN
Fig. 3



1350
SELDIN
Fig. 4L



1351
SELDIN
Fig. 4R



1352
SELDIN
Fig. 1L



1353
SELDIN
Fig. 1R

Swa Elevators & Root Screws



1354



1355

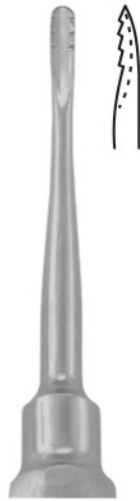

1356



1357

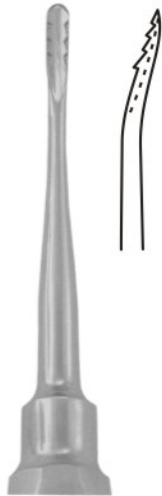

1358

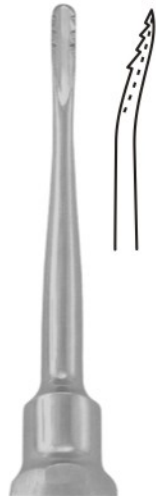

1359

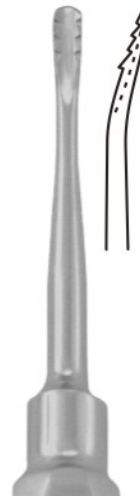

1360

Root Screws



1362
Morrison
2.0 mm



1363
Morrison
2.5 mm



1364
Morrison
3.0 mm

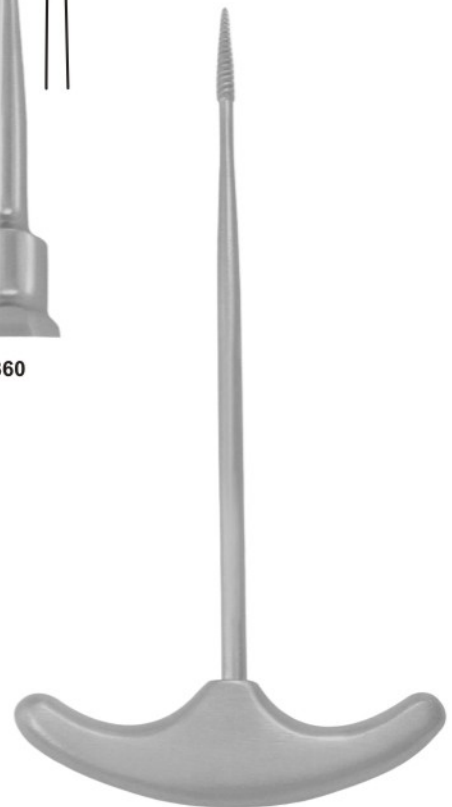

1361
Morrison
3.5 mm



1365
IS-APICAL



1366
APICAL
2 mm
Fig. 1



1367
APICAL
3 mm
Fig. 2



1368
APICAL
4 mm
Fig. 3



1369
APICAL
4.5 mm
Fig. 4



1370
APICAL
2 mm
Fig. 5



1371
APICAL
3 mm
Fig. 6



1372
APICAL
4 mm
Fig. 7



1373
APICAL
4.5 mm
Fig. 8



1374
APICAL
Fig. 9



1375
WINTER
Fig. 14 L



1376
WINTER
Fig. 14 R



1377
HEIDBRINK
Fig. 1



1378
HEIDBRINK
Fig. 2



1379
FLOHR
Fig. 1



1380
FLOHR
Fig. 2



1381
APICAL
Fig. 1



1382
APICAL
Fig. 2



1383
IS-CRYER



1384
CRYER
Fig. 1



1385
CRYER
Fig. 2



1386
IS-COUPLAND



1387
COUPLAND
Fig. 1



1388
COUPLAND
Fig. 2



1389
COUPLAND
Fig. 3



1390
Fig. 1



1391
Fig. 2

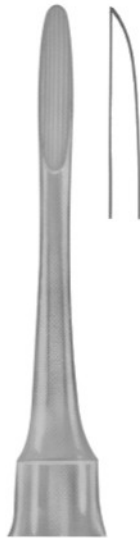

1392
Fig. 3



1393
FLOHR
Fig. 1

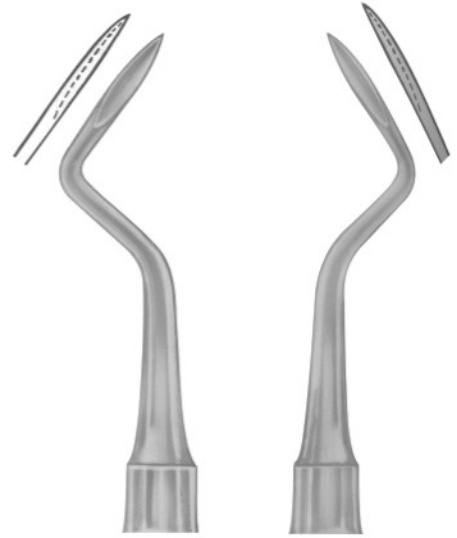

1394
FLOHR
Fig. 2

1395
FLOHR
Fig. 3



1396
KOPP
Fig. 1



1397
KOPP
Fig. 2



1403
KOPP
Fig. 1



1404
KOPP
Fig. 2



1396
KOPP



1398
KOPP
Fig. 3



1399
KOPP
Fig. 4



1402
KOPP



1405
KOPP
Fig. 3



1406
KOPP
Fig. 4



1400
KOPP
Fig. 5



1401
KOPP
Fig. 6

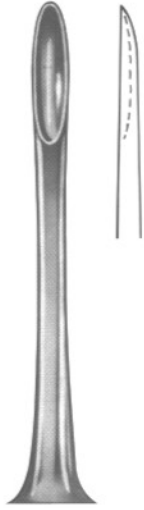

1407
HYLIN
Fig. 1

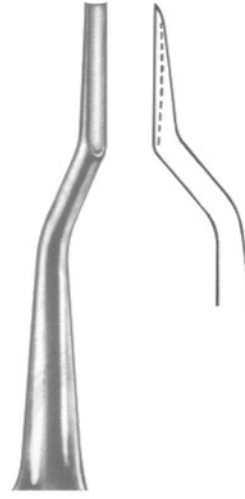

1409
BEIN
Fig. 1

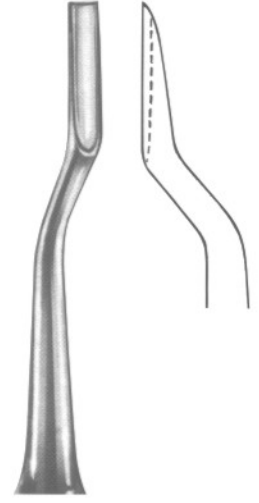

1410
BEIN
Fig. 2

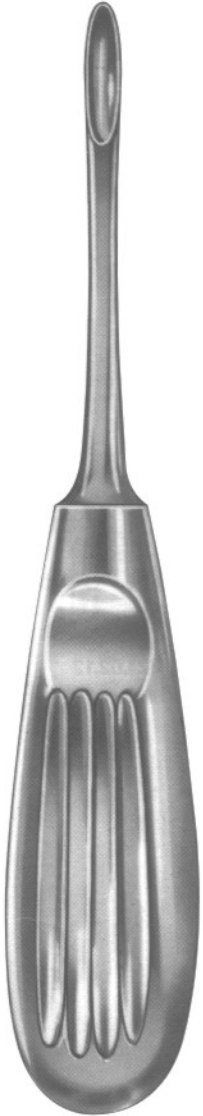

1407
HYLIN

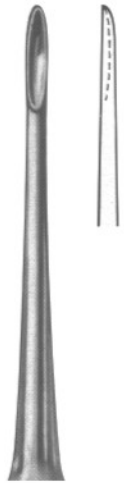

1408
HYLIN
Fig. 2



1409
BEIN

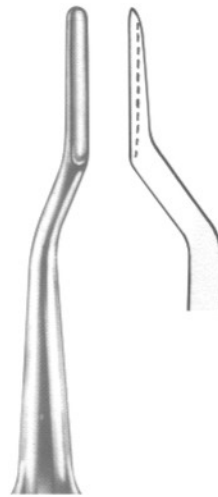

1411
BEIN
Fig. 3

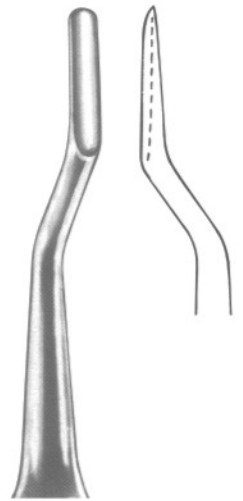

1412
BEIN
Fig. 4



1413
WARWICK-JAMES
Fig. 1



1413
Warwick-James
Fig. 2



1414
Warwick-James
Fig. 3



1415
London-Hospital
Fig. 1



1415
London-Hospital
Fig. 2



1416
London-Hospital
Fig. 3

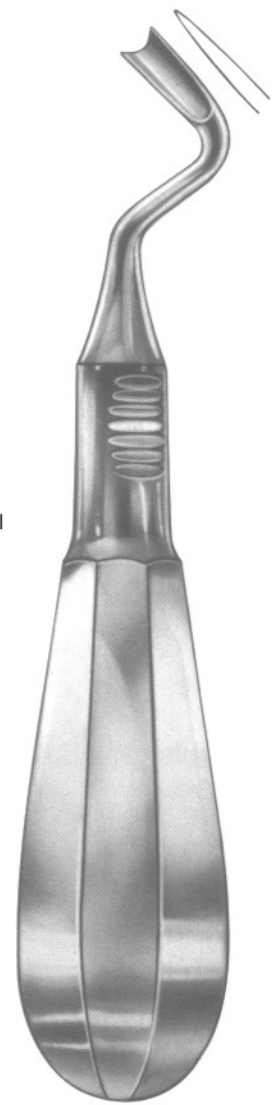

1417
OTT



1418
CHOMPRET
Fig. 1



1419
CHOMPRET
Fig. 2



1420
CHOMPRET
Fig. 3



1421
CHOMPRET
Fig. 4



1423
Fig. 1



1422
Fig. 2

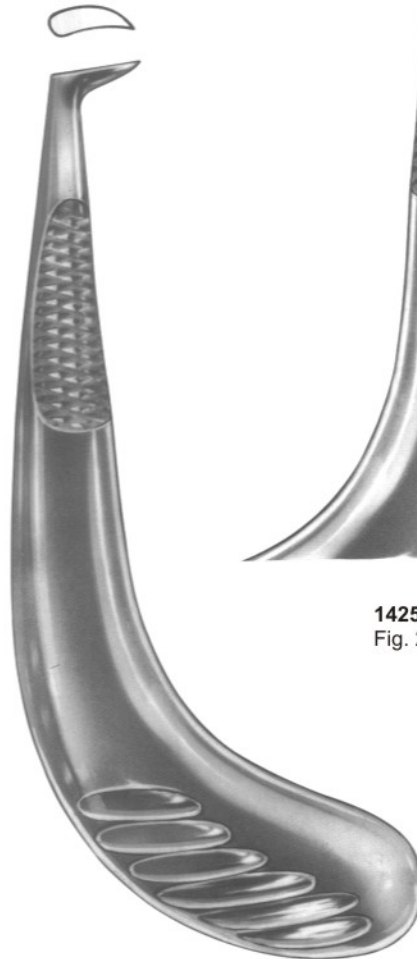

1424
Fig. 1



1425
Fig. 2



1426
APICAL

Root Tip Elevators



1427
IS-Fig. 1



1428
Fig. 2



1429
Fig. 3

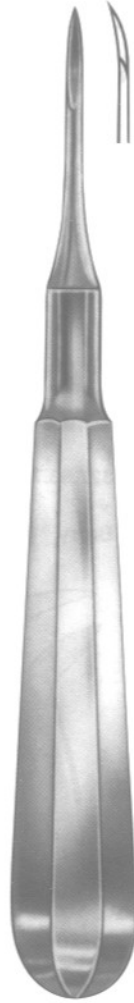

1430
HEIDBRINK
Fig. 1



1431
HEIDBRINK
Fig. 2



1432
HEIDBRINK
Fig. 3



1438
MEAD
MD1



1433
LECLUSE



1434
MEAD
MD-5 A



1435
MEAD
MD-6 A



1436
MEAD
MD-7 A



1437
MEAD
MD-8



1439
WINTER
Fig. 1L



1440
WINTER
Fig. 1R



1441
WINTER
Fig. 2L



1442
WINTER
Fig. 2R

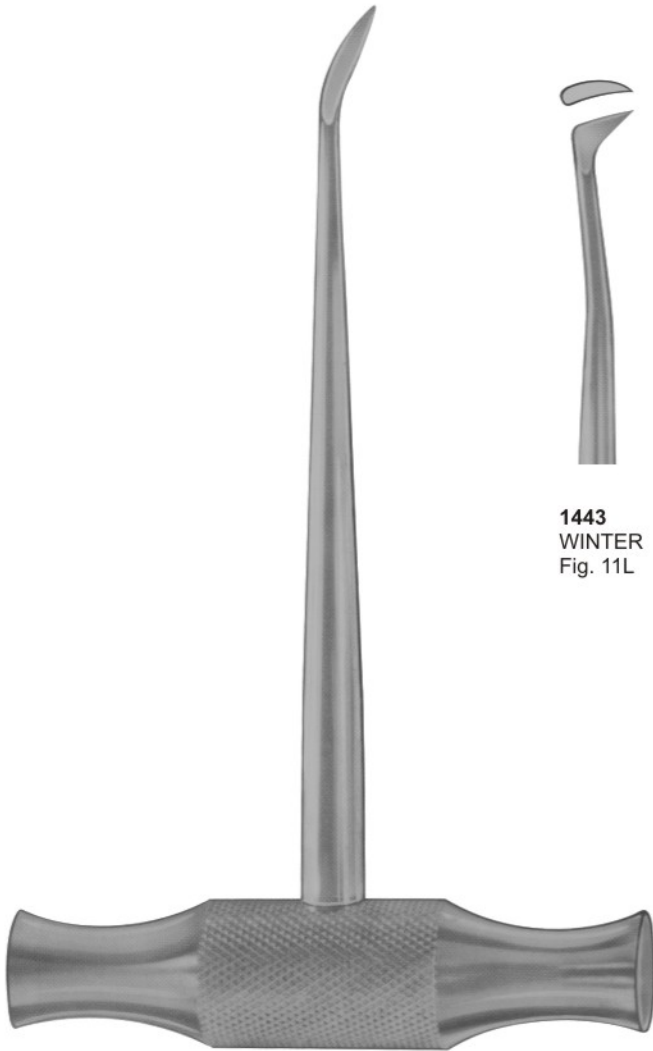

1439
WINTER



1443
WINTER
Fig. 11L



1444
WINTER
Fig. 11R



1445
WINTER
Fig. 12L



1446
WINTER
Fig. 12R



1447
WINTER
Fig. 14L



1448
WINTER
Fig. 14R



1449
BARRY
Fig. 1



1450
BARRY
Fig. 2



1451
BARRY
Fig. 3



1452
BARRY
Fig. 4



1449
BARRY



1453
BARRY
Fig. 11



1454
BARRY
Fig. 12



1455
BARRY
Fig. 17



1456
BARRY
Fig. 18



1458
CRYER
Fig. 26

1459
SELDIN
Fig. 27

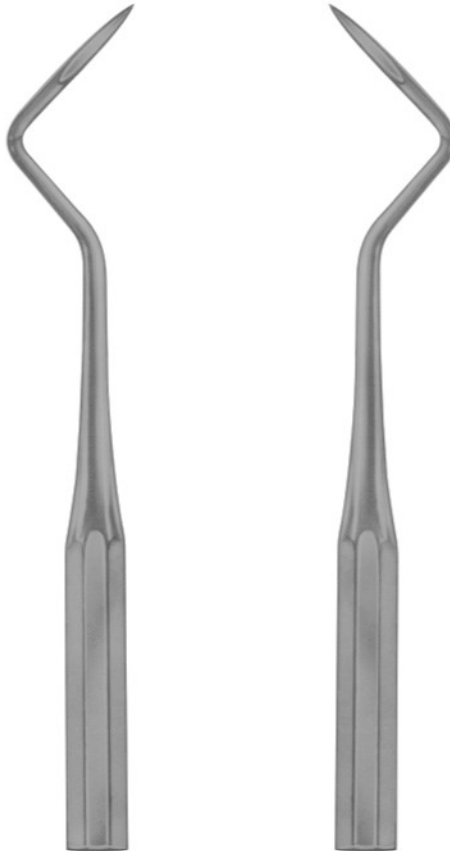

1460
CRYER
Fig. 28

1461
CRYER
Fig. 29



1462
HEIDBRINK
Fig. 22

1463
HEIDBRINK
Fig. 23

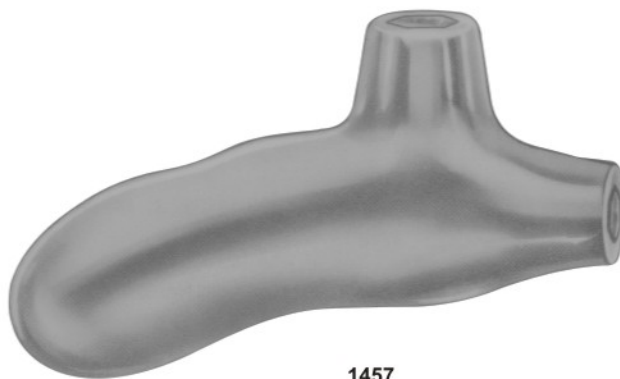

1457



1465
KOPP
Fig. 31



1466
KOPP
Fig. 32



1467
KOPP
Fig. 33



1468
KOPP
Fig. 34



1469
KOPP
Fig. 35



1470
KOPP
Fig. 44

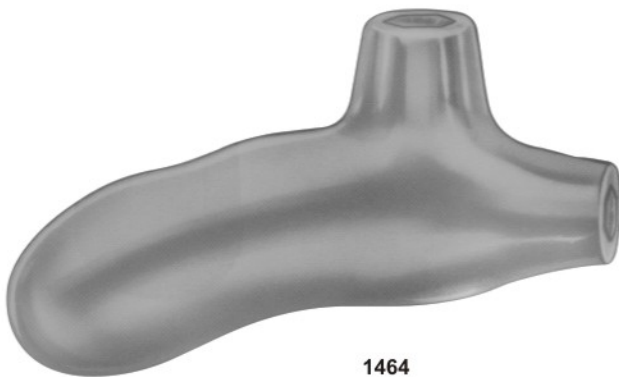

1464



1472
HEIDBRINK
Fig. 10



1473
WINTER
Fig. 11



1474
WINTER
Fig. 12



1475
BARRY
Fig. 17



1476
BARRY
Fig. 18



1477
BARRY
Fig. 20



1471

Root Elevators according to Dr. Sader,
with interchangeable working tips

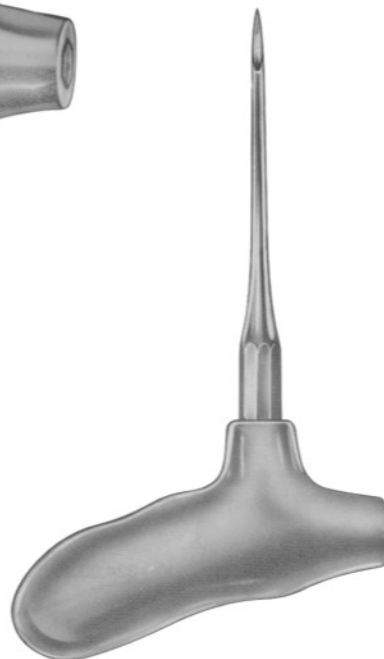

1478



1479



1480

Elevators Plastic Handle

1481
Root Elevator, Plastic Handle, Set of 10 Pcs

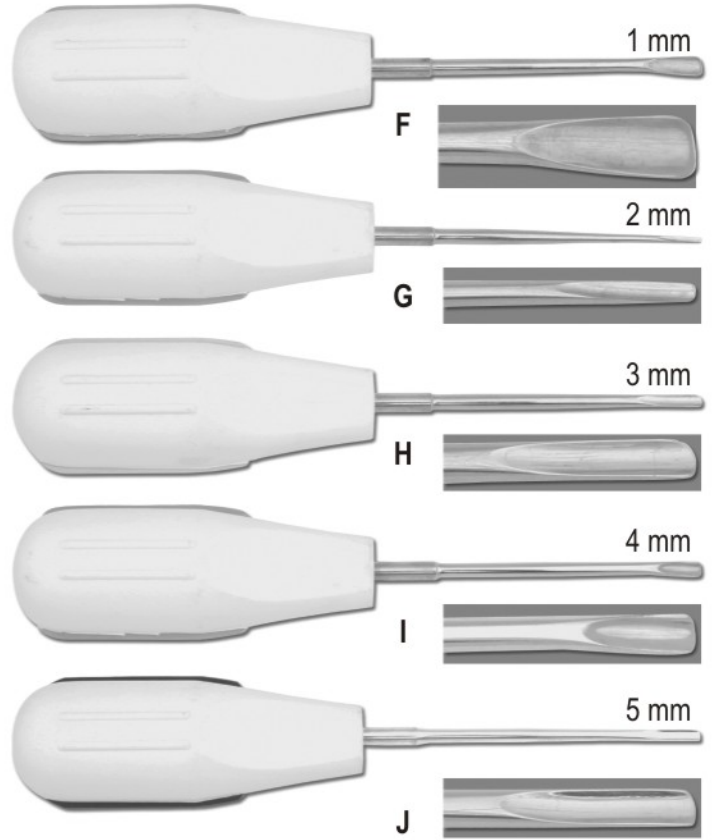
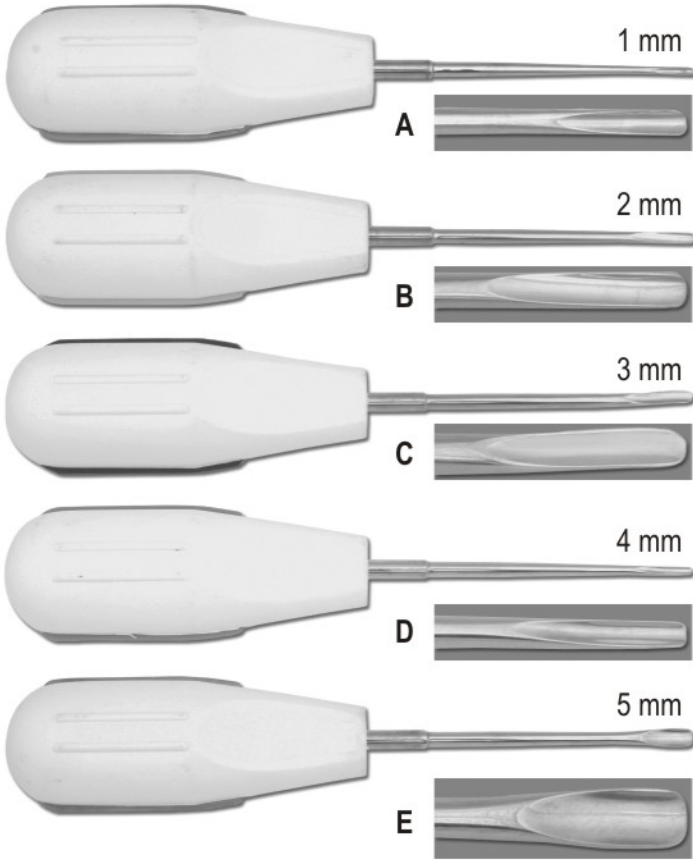

1482
Root Elevator, Plastic Handle, Set of 5 Pcs

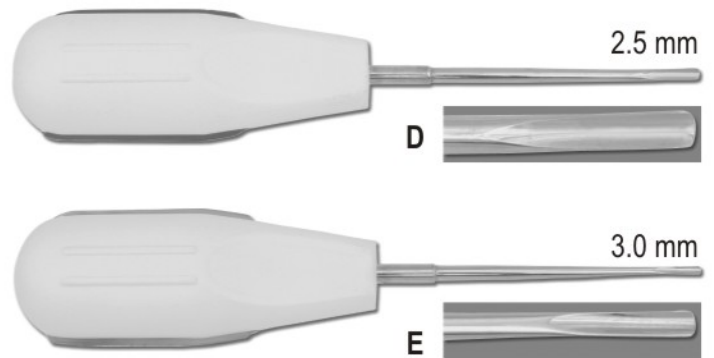
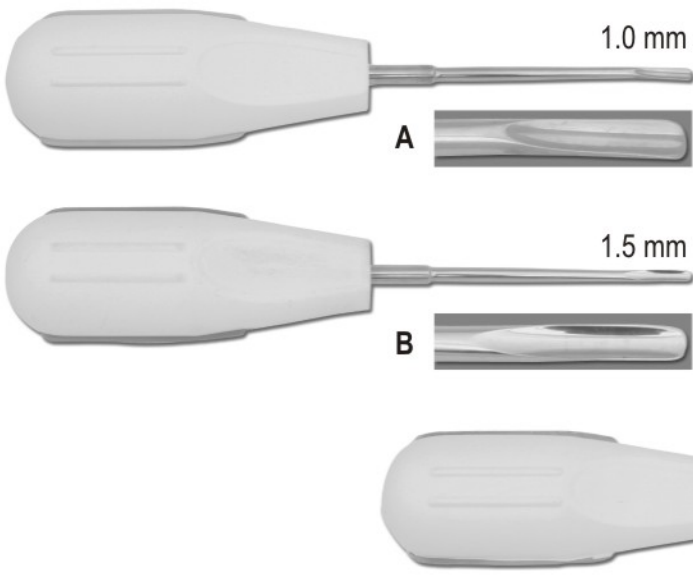

- ◊ Scalpel Handles
- ◊ Mouth Mirrors and Handles
- ◊ Explorer and Probes
- ◊ Endodontics
- ◊ Excavators



02

SECTION



Scalpel Handles



1483

Scalpel Handle Angle Of Blade Adjusts To Easily Get Around Corners
Adjustment Sets Blade From Straight To Back Angled
Locks In At 90°, 60°, 30°, Straight, -30°, -60° Angles



1484

Scalpel Handle
Fig. 5



1485

Scalpel Handle
Curved

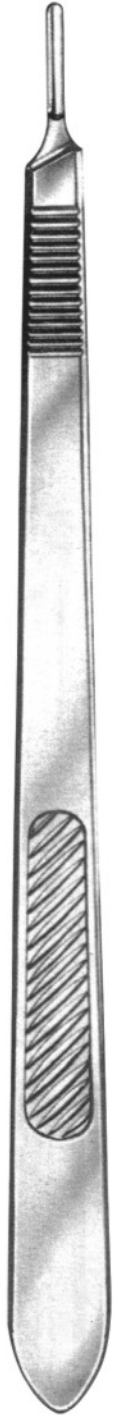

1486
Fig. 3L



1487
Fig. 7



1488
Scalpel Handle
Fig. 4L, Curved
20 cm



1489
Fig. 3



1490
Fig. 3G



1491
Fig. 4



1492



1493
Scalpel Handle
4 D 14.0 cm



1494
Mess Holders



1495
Gouge
Blade Handle
Fig. 2 / 11.5 cm

Handles

Handle For Mouth Mirrors, Probes, Explorers, Excavators, Carvers, Curettes & Scalars



1496

Handle No. 2 Standard Single Ended



1497

Handle Single Ended



1498

Handle Single Ended



1499

Handle Single Ended

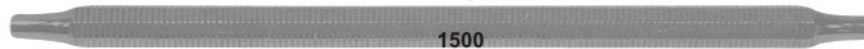

1500

Octagonal Double Ended



1501

Octagonal Double Ended



1502

Octagonal Double Ended



1503

Handle No. 2 (Standard Double Ended)



1504

Octagonal Double Ended



1505

Tactile Tone Double Ended



1506

Tactile Tone Double Ended



1507

Tactile Tone Double Ended



1508

Handle, Double Ended



1509

Double Ended

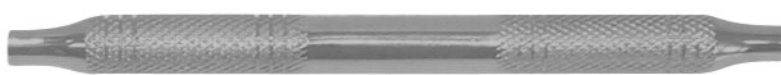

1510

Tactile Tone Double Ended



1511

Tactile Tone Double Ended

Handles & Mouth Mirrors

Mouth Mirrors

Plane



1514
Fig.6
Ø 26 mm

1515
Fig.5
Ø 24 mm

1516
Fig.4
Ø 22 mm

Magnifying



1517
Fig.6
Ø 26 mm

1518
Fig.5
Ø 24 mm

1519
Fig.4
Ø 22 mm

Front surface



1520
Fig.6
Rhodium
Ø 26 mm
Front surface

1521
Fig.5
Rhodium
Ø 24 mm
Front surface

1522
Fig.4
Rhodium
Ø 22 mm
Front surface

Plane



1523
Fig.6
Ø 26 mm

1524
Fig.5
Ø 24 mm

1525
Fig.4
Ø 22 mm

With cone - socket

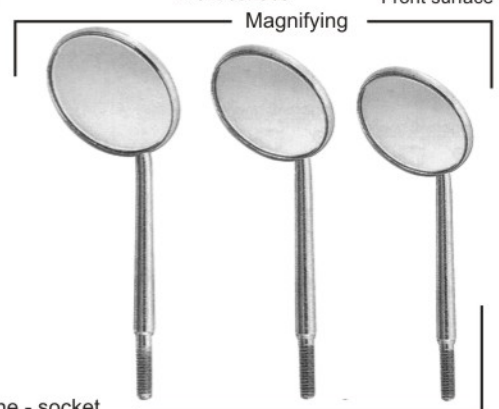

1526
Fig.6
Ø 26 mm

1527
Fig.5
Ø 24 mm

1528
Fig.4
Ø 22 mm

Mouth Mirrors, Magnifying 1513-A Plain 1512-B

| | | |
|---------|---|-------|
| Fig. 00 | Ø | 8 mm |
| Fig. 0 | Ø | 10 mm |
| Fig. 1 | Ø | 14 mm |
| Fig. 2 | Ø | 16 mm |
| Fig. 3 | Ø | 18 mm |
| Fig. 4 | Ø | 20 mm |
| Fig. 5 | Ø | 22 mm |
| Fig. 6 | Ø | 24 mm |
| Fig. 7 | Ø | 26 mm |
| Fig. 8 | Ø | 28 mm |
| Fig. 9 | Ø | 30 mm |
| Fig. 10 | Ø | 32 mm |

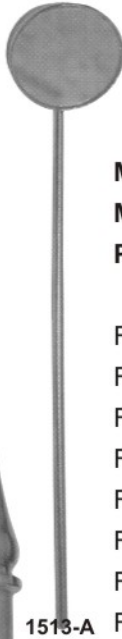

1512
Hollow Handle
Fig.1



1513
Hollow Handle
Fig.2

Mirror Handle, Mouth Mirrors



1529



1530



1531



1532



1533



1534



1535
Parallelometer
mouth mirror

1536
Parallelometer
mouth mirror
+ handle
code 2101



1537
Tactile Tone
Single Ended



1538
Handle
Thompson
Single Ended



1539
Hollow Handle



1540
Hollow Handle
Stainless
Steel



1541
Cone-socket
Hollow Handle



1542
Hollow Handle



1543
Hollow Handle

SCALERS - JAQUETTE

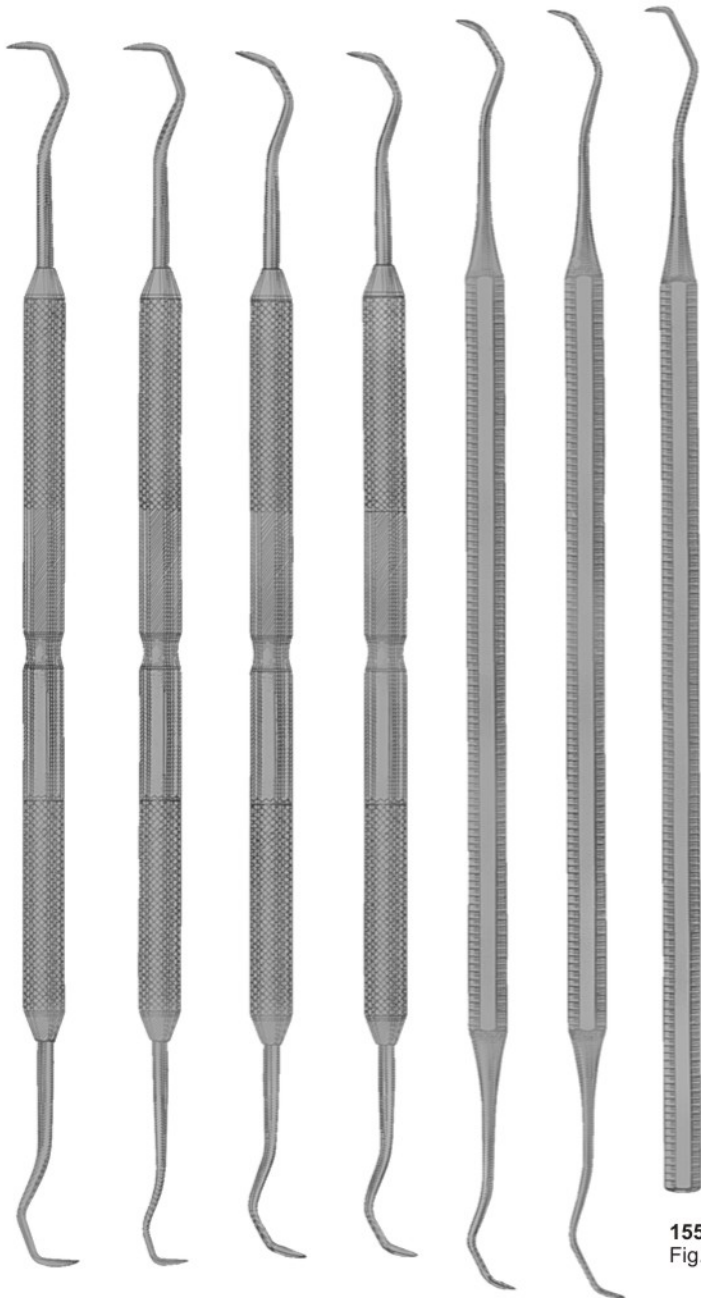

1544 1Y-1Y
1545 1Y-1YS
1546 2Y-3Y
1547 2YS-3YS
1548 2-3
1549 2S-3S

1550
Fig.1

SCALERS - OCTAGONAL

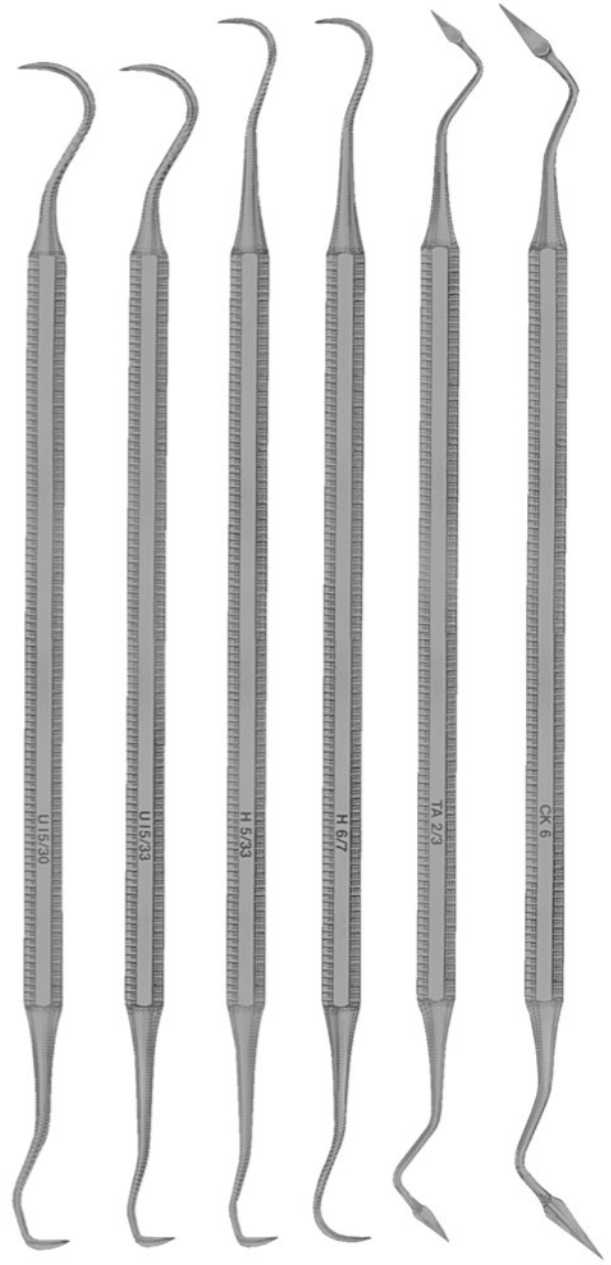

1551 U15-30
1552 U15-33
1553 H5-33
1554 H6-7
1555 Taylor 2-3
1556 CK6



1557
U15

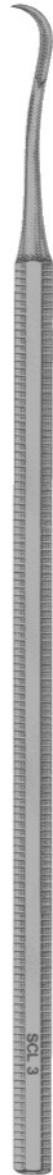

1558
No. 3

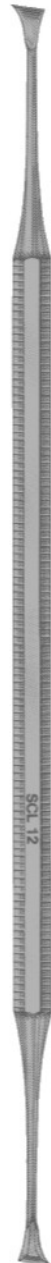

1559
No. 12



1560
WHITESIDE 1-0

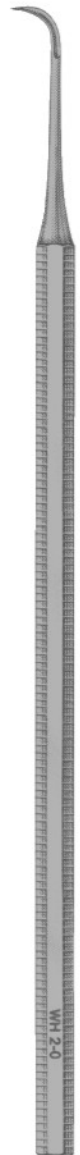

1561
WHITESIDE 2-0

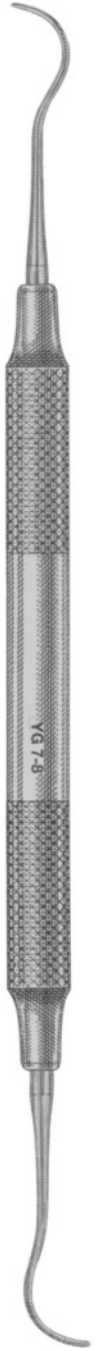

1562
YAOUNGER/GOOD
7-8

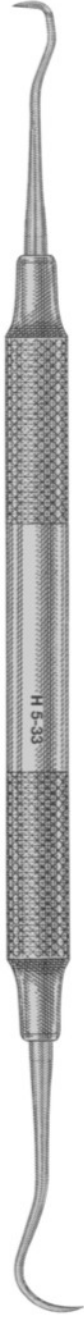

1563
H5-33



1564
204SD



1565
H6-7



1566
204S



1567
TOWNER/JAQUETTE
U15-30

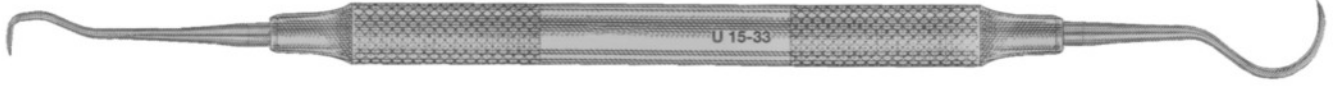

1568
JAQUETTE (33-U15)



1569
JAQUETTE
2Y-3Y



1570
JAQUETTE
30-U15



1571
JAQUETTE
2YS-3YS



1572
JAQUETTE
33-H5



1573
YOUNGER/GOOD
7-8

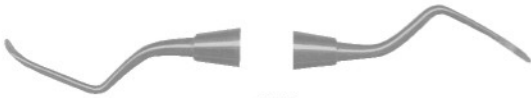

1574
204S

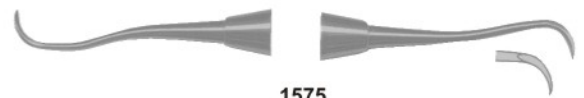

1575
204SD



1576
H6-7

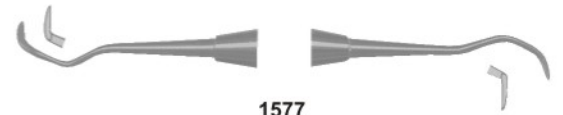

1577
JAQUETTE
2S-3S



1578
JAQUETTE
1Y-1YS



1579
JAQUETTE
2-3



1580
JAQUETTE (33-U15)



1581
S204



1583
S204S



1585
S204SD



1587
Goldman 6-7

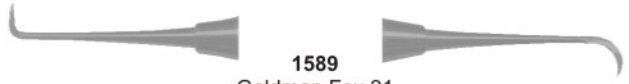

1589
Goldman Fox 21



1591
H5-U15



1593
Jaquette 34-35



1595
Thompson Jr.



1597
UT107-108



1599
UP128



1582
Jack-Nebraska



1584
Jaquette 1-U15



1586
Jaquette 2-3



1588
Jaquette 2S-3S



1590
Jaquette 30-U15

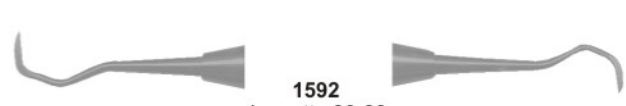

1592
Jaquette 30-33



1594
Jaquette 31-32



1596
Jaquette 33-H5



1598
U 6-7



1600
128L

Explorers Double Ended - Octagonal

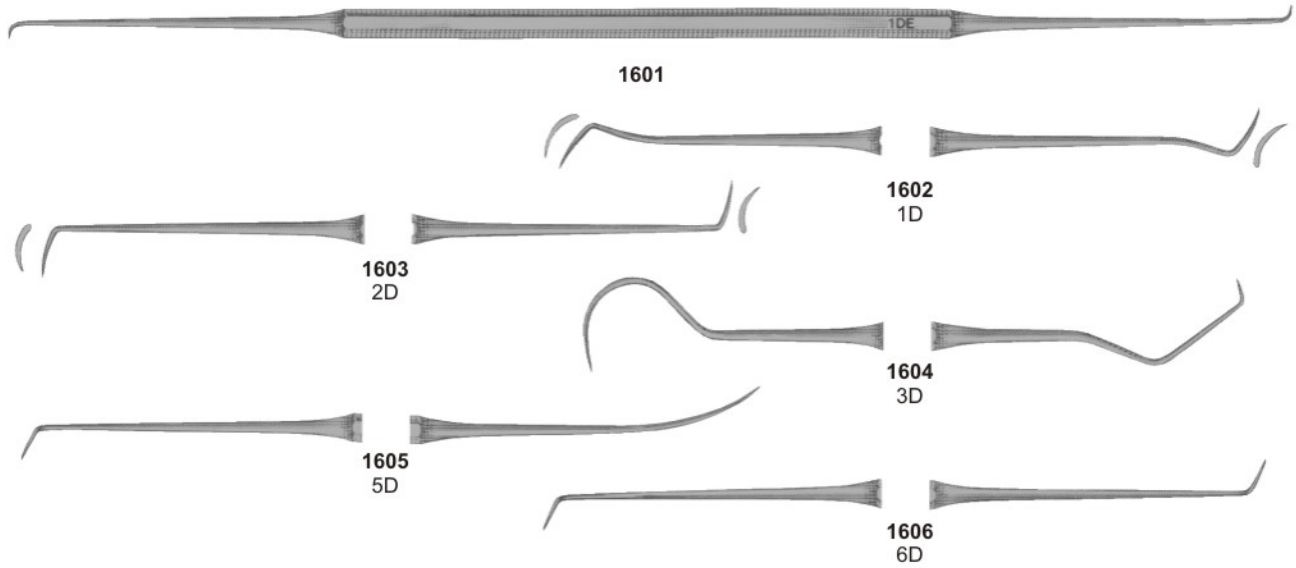

Explorers Double Ended - Standard

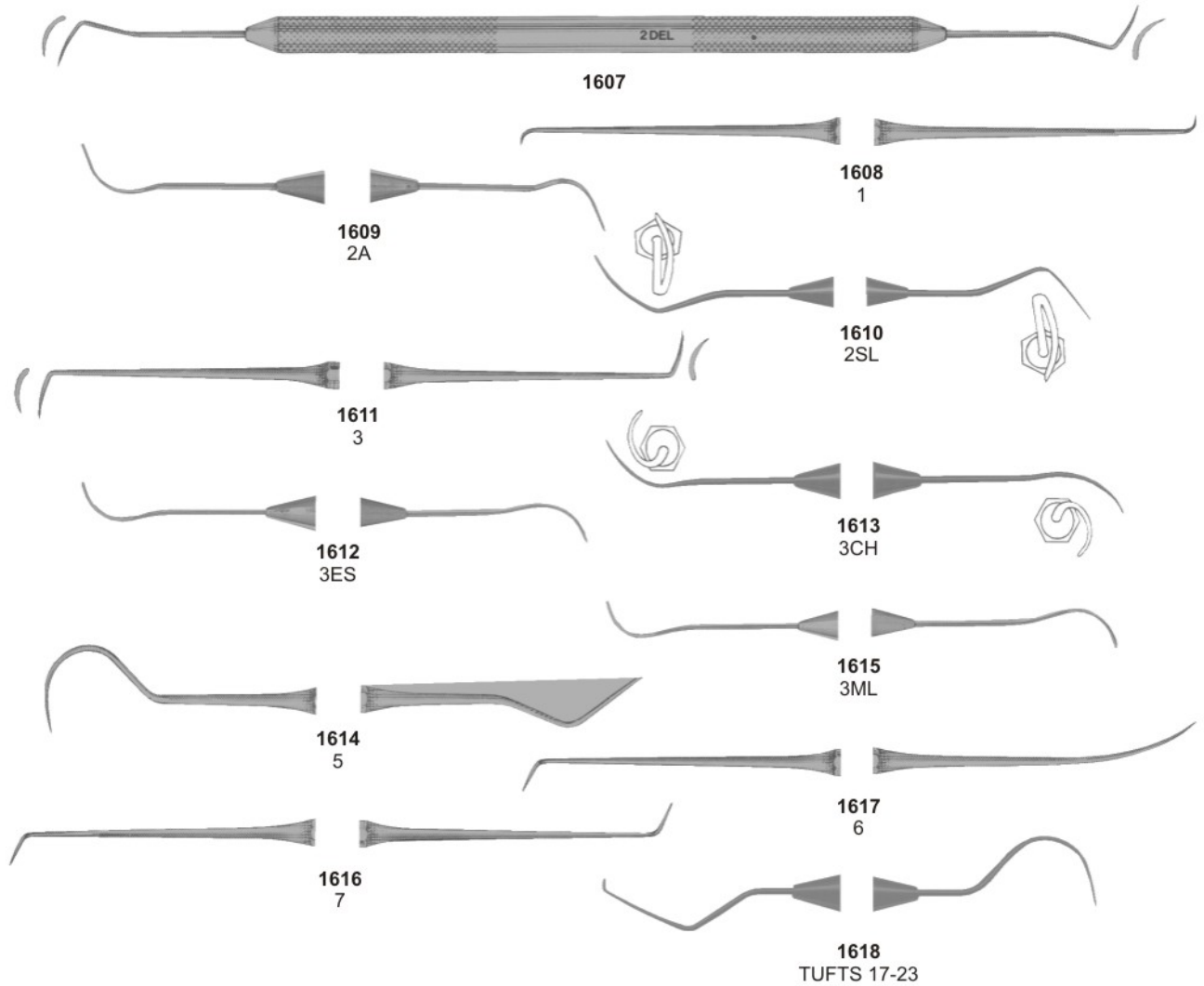

Explorers Double Ended Tactile Tone



1619
2A



1620
2



1621
1



1622
2SL



1623
3



1624
3CH



1625
3ES



1626
3ML

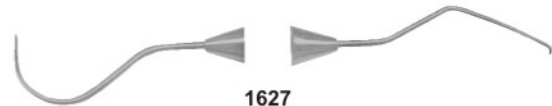

1627
5



1628
6



1629
7

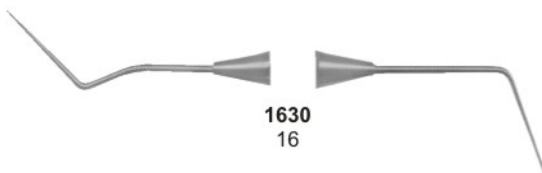

1630
16



1631
TUFTS 17/23

Explorers Single Ended - Octagonal

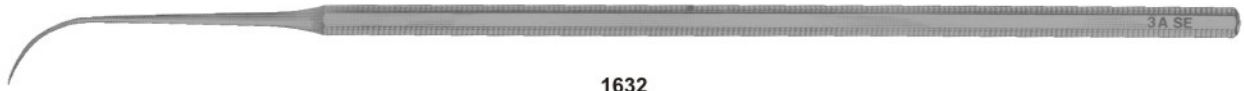

1632
Fig. 3A



1633
Fig. 6



1634
Fig. 7



1635
Fig. 17



1636
Fig. 23

Explorers Single Ended - Standard

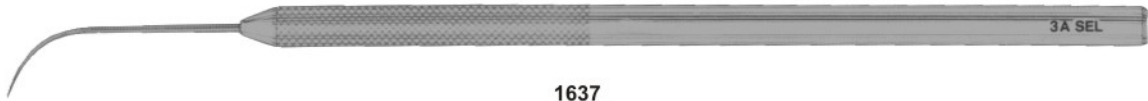

1637
Fig. 3A



1638
Fig. 6



1639
Fig. 7



1640
Fig. 17



1641
Fig. 23

Probe / Explorer - Octagonal

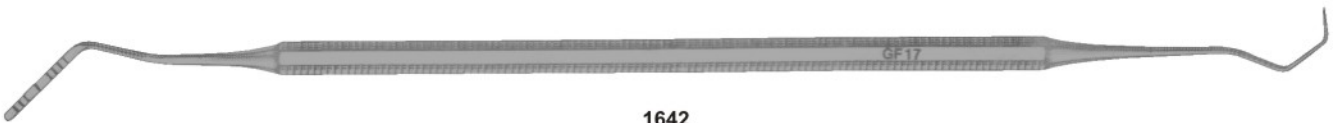

1642
GF-17

Double Ended Probe - Octagonal



1643
GF-18 (1-2)

Probes Double Ended - Standard

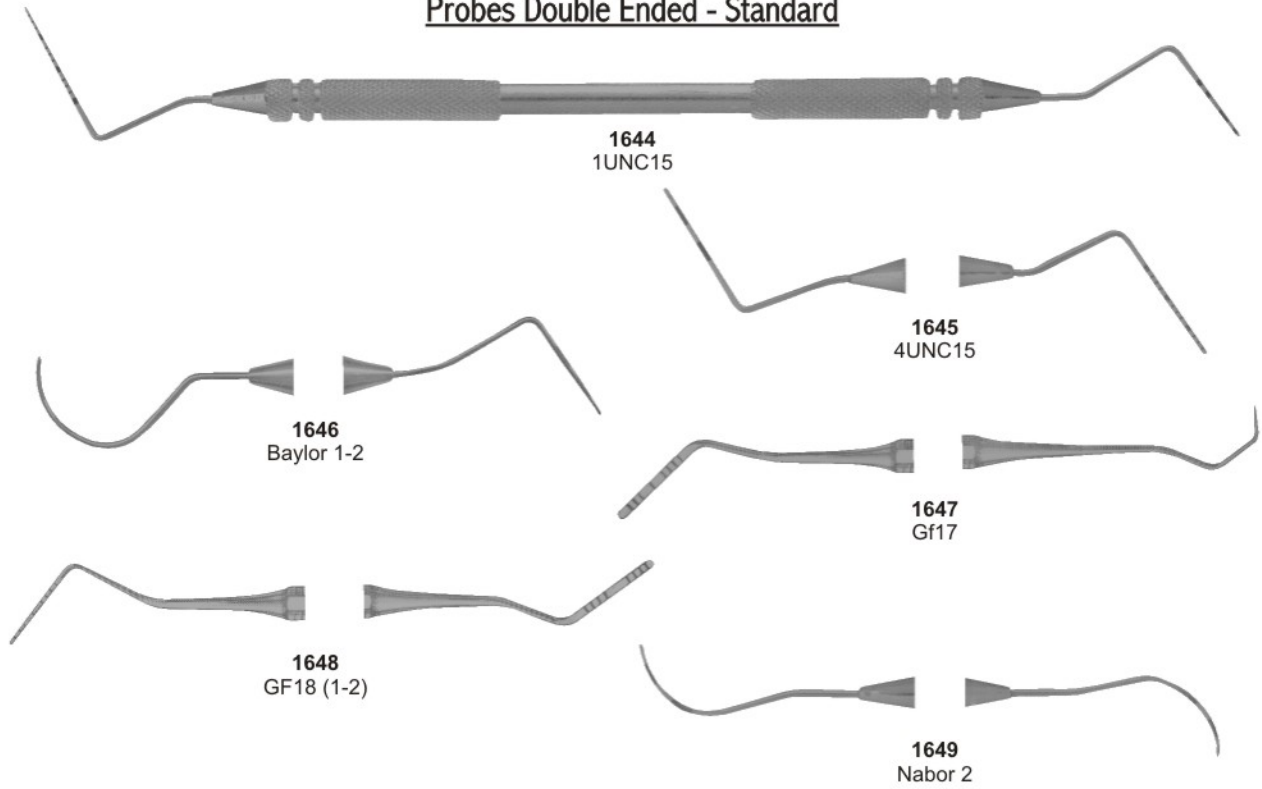

Probes Double Ended - Tactile Tone

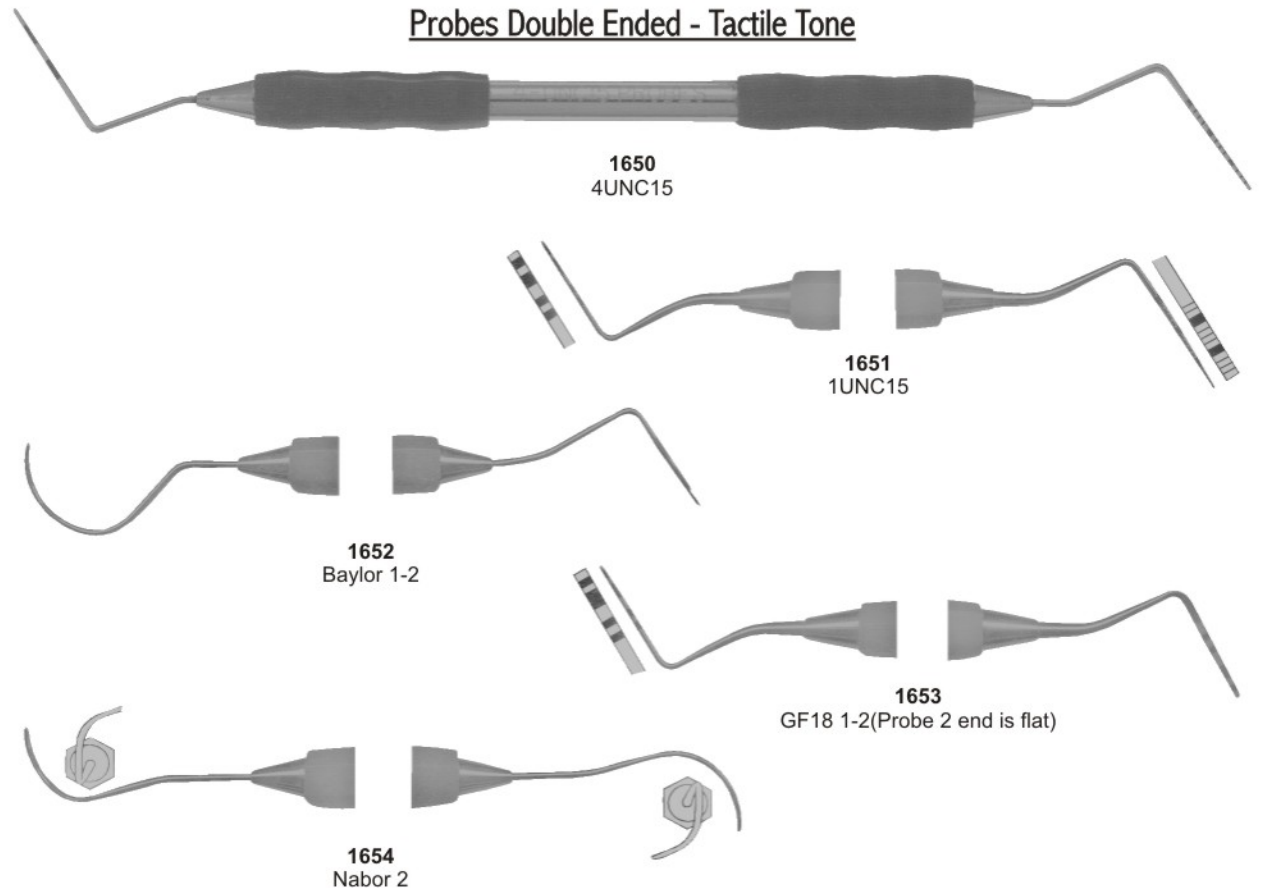

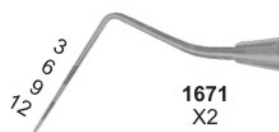
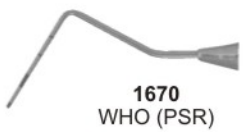
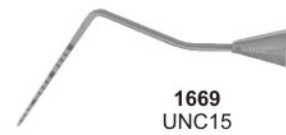
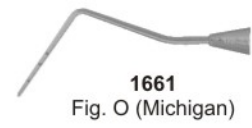
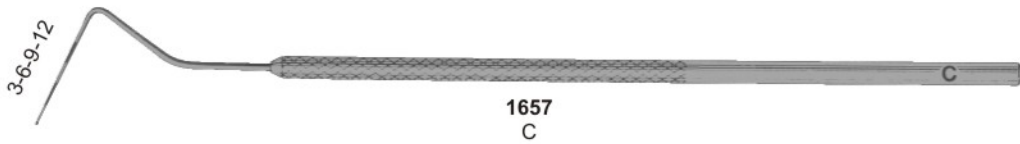
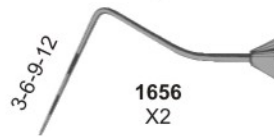
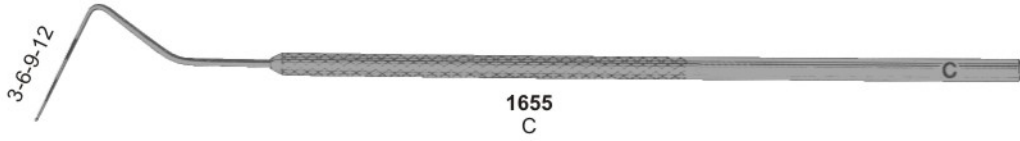

PROBES DOUBLE ENDED STANDARD

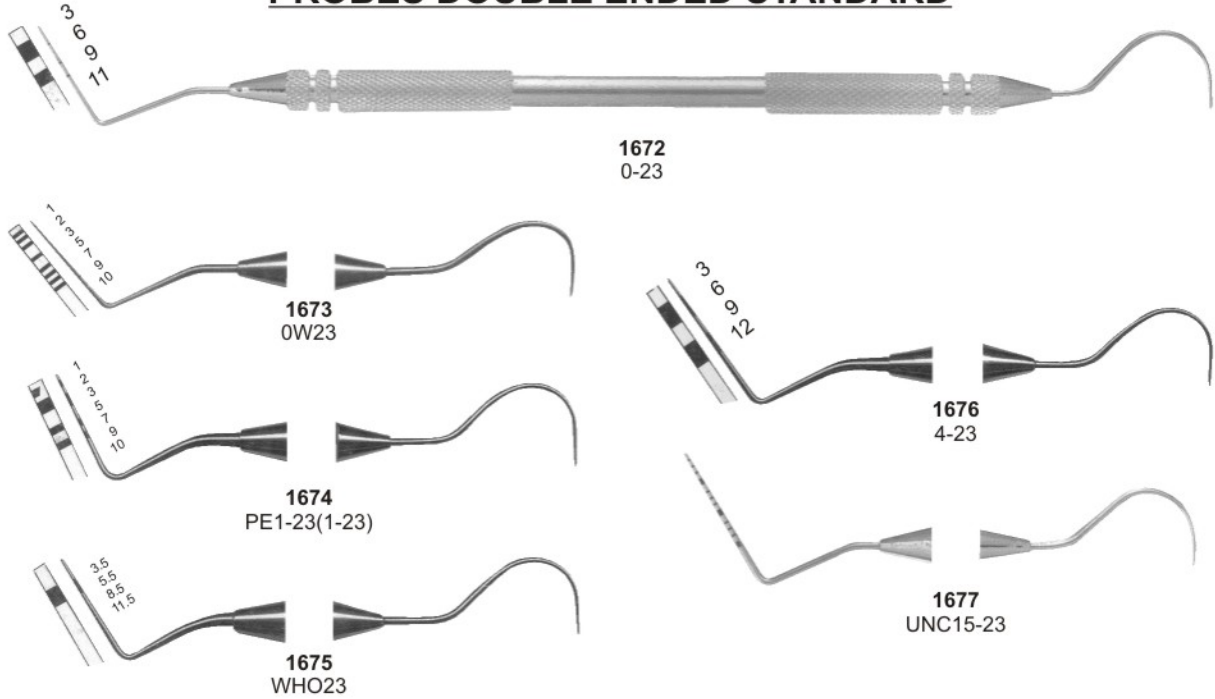

PROBES DOUBLE ENDED TACTILE TONE

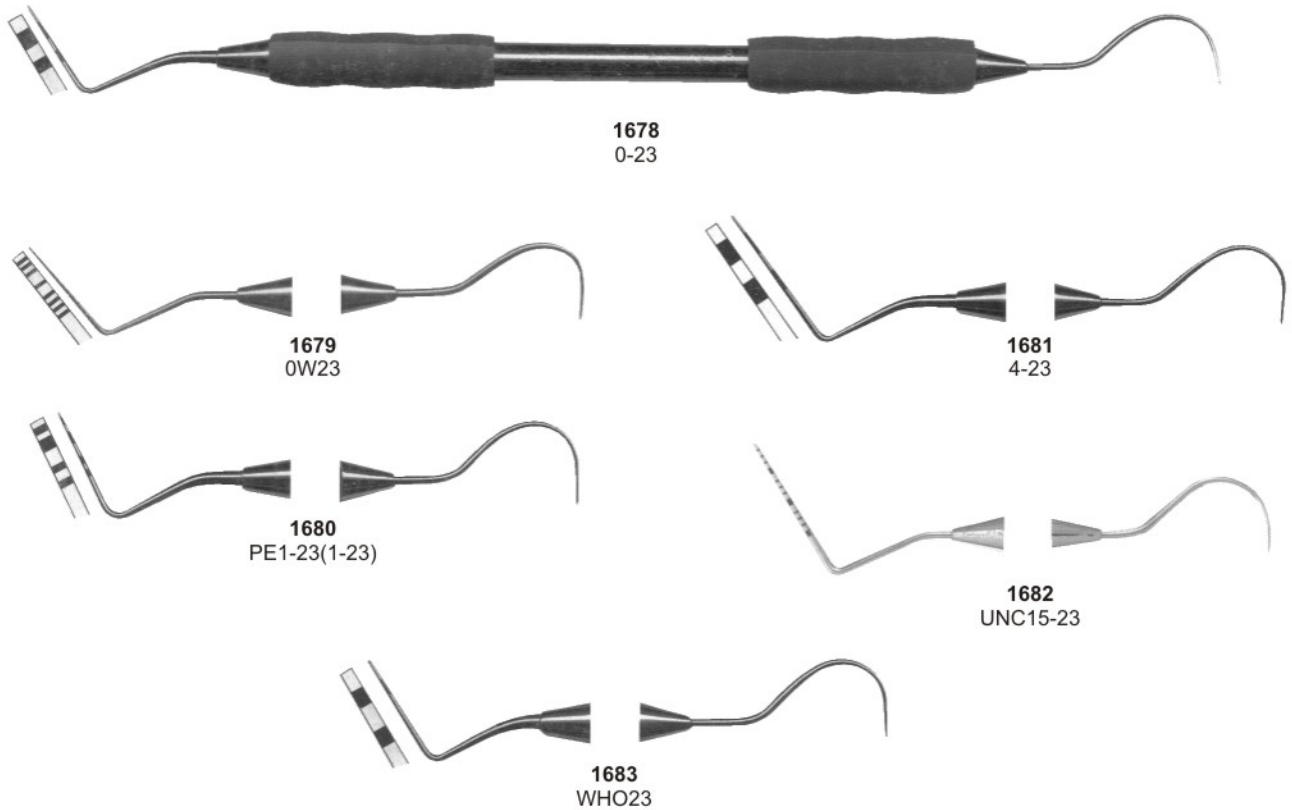

Endodontic Condensers

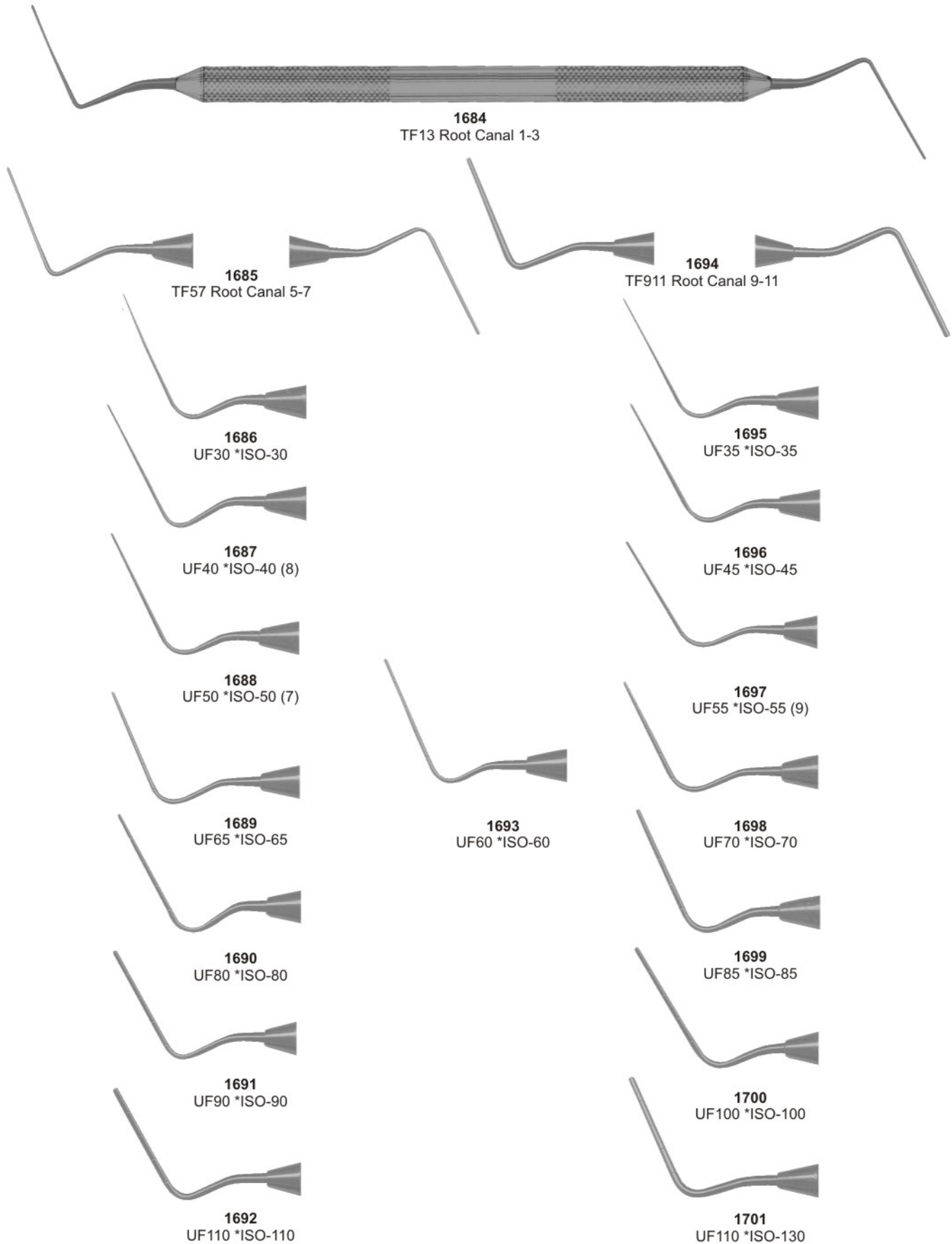

Endodontic Condensers/Spreaders



1702
UF120X



1703
UF45N



1704
UF60N



1705
UF80N



1706
UF100X



1707
UE25 R-25



1708
UE30 R-30

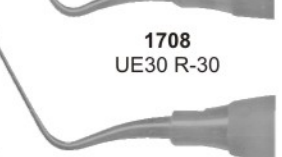

1709
UE35 R-35



1710
UE40 R-40



1711
UE45 R-45



1712
UE50 R-50



1713
UF120X



1714
UF140X



1715
TFD3545N



1716
TFD6080N



1717
UE55 R-55



1718
UE60 R-60



1719
UE25N R-25

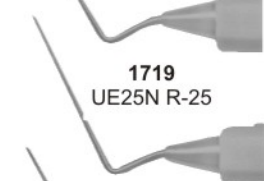

1720
UE30N R-30

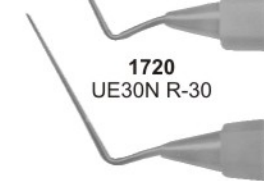

1721
UE40N R-40

Obturation Instruments

1722
No. D11

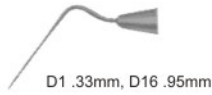

1723
No. D11T

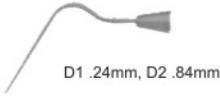

1724
No. KR1



1725
No. 25S

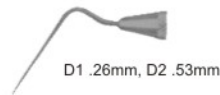

1726
No. W1S

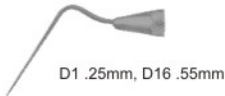

1727
No. W2S

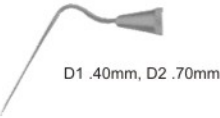

1728
Lucks No.1



1729
Lucks No.2



1730
Lucks No.3



1731
Lucks No.4

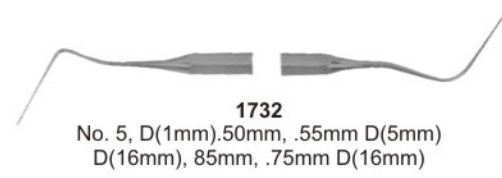

1732
No. 5, D(1mm).50mm, .55mm D(5mm)
D(16mm), 85mm, .75mm D(16mm)

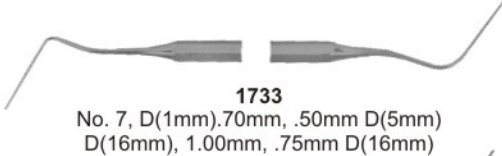

1733
No. 7, D(1mm).70mm, .50mm D(5mm)
D(16mm), 1.00mm, .75mm D(16mm)

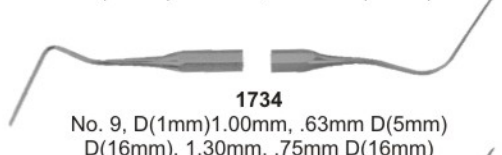

1734
No. 9, D(1mm)1.00mm, .63mm D(5mm)
D(16mm), 1.30mm, .75mm D(16mm)

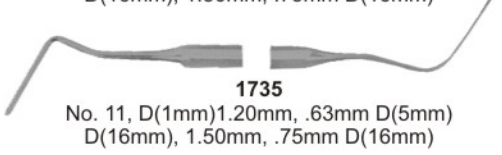

1735
No. 11, D(1mm)1.20mm, .63mm D(5mm)
D(16mm), 1.50mm, .75mm D(16mm)



1736
No.1 (D1 .35mm, D16 .75mm)



1737
No.2 D1 .55mm, D16 .85mm

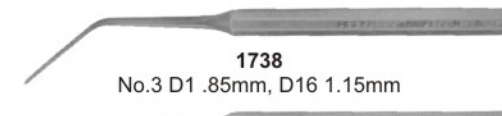

1738
No.3 D1 .85mm, D16 1.15mm



1739
No.4 D1 1.00mm, D16 1.30mm

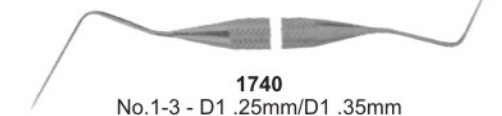

1740
No.1-3 - D1 .25mm/D1 .35mm



1741
No.3-5 - D1 .35mm/D1 .55mm



1742
No.5-7 - D1 .55mm/D1 .70mm



1743
No.9-11 - D1 1.00mm/D1 1.20mm

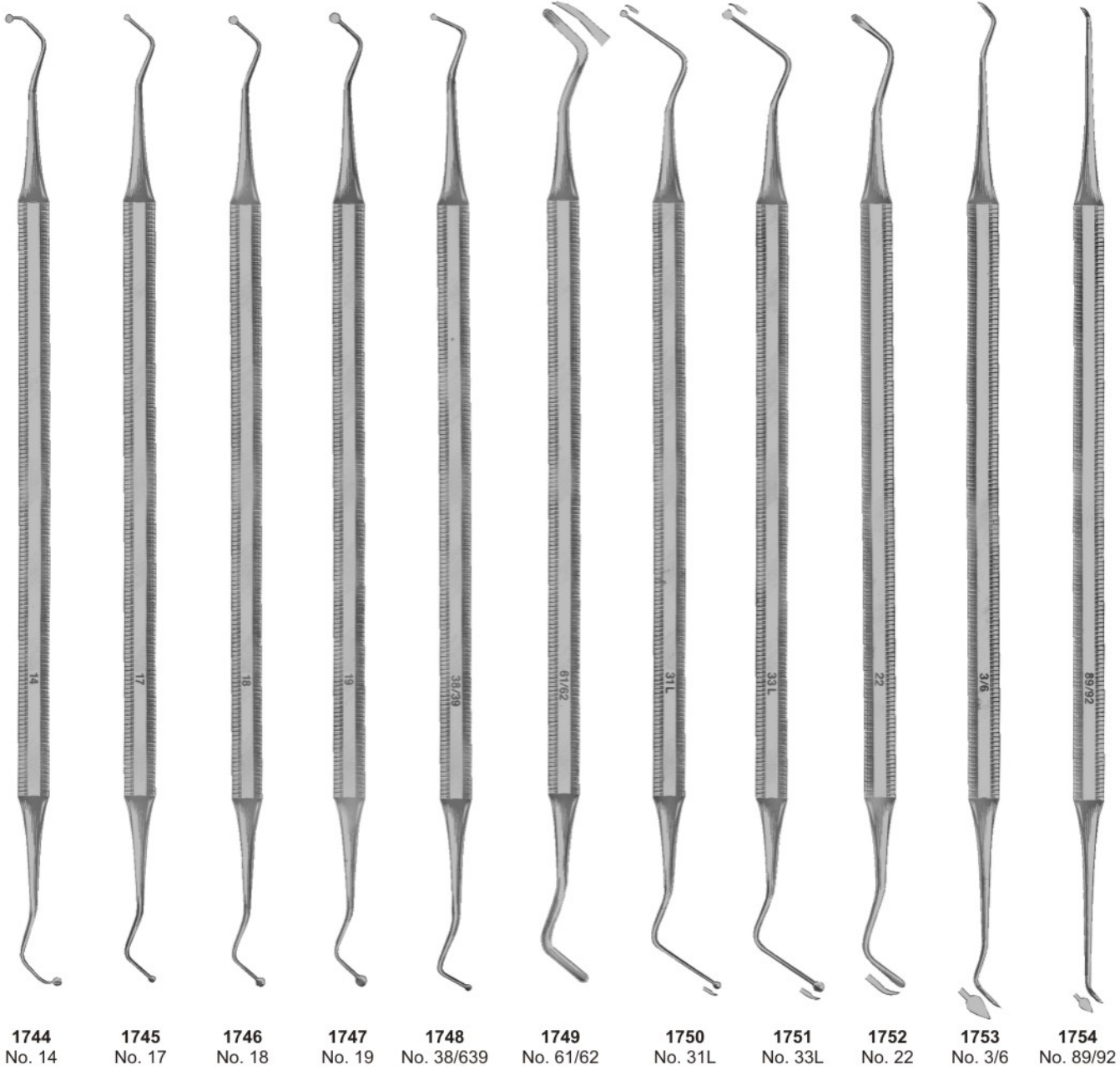

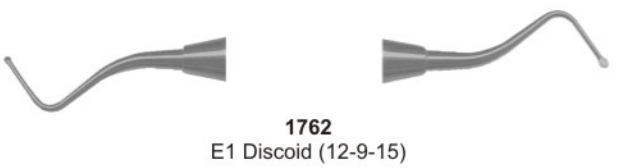
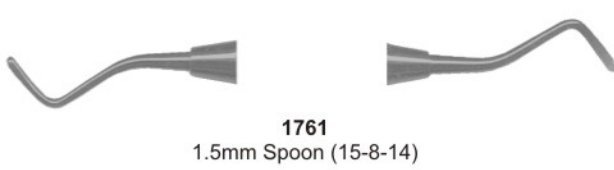
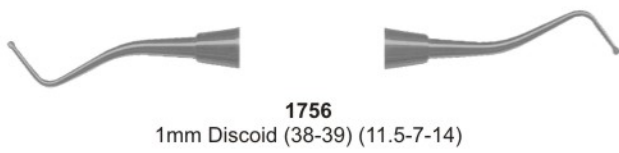
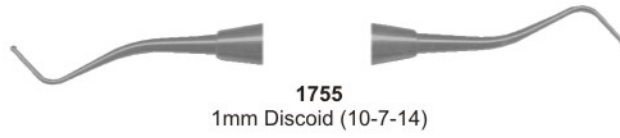

Excavators, Explorer / Probes

Excavators

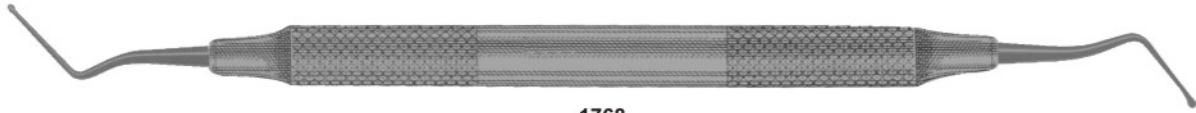

1768
31L



1769
31W



1770
33L



1771
32L



Explorers / Probes



1772
G16D-L



1773
Explorer No.2



1774
Explorer No.16

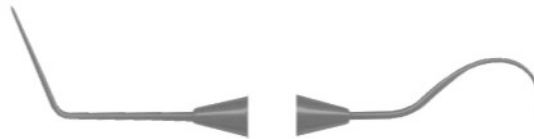

1775
16-23 Explorer



1776
16-17 Explorer



1777
DG16 Explorer



1778
(Heavy DG-16)



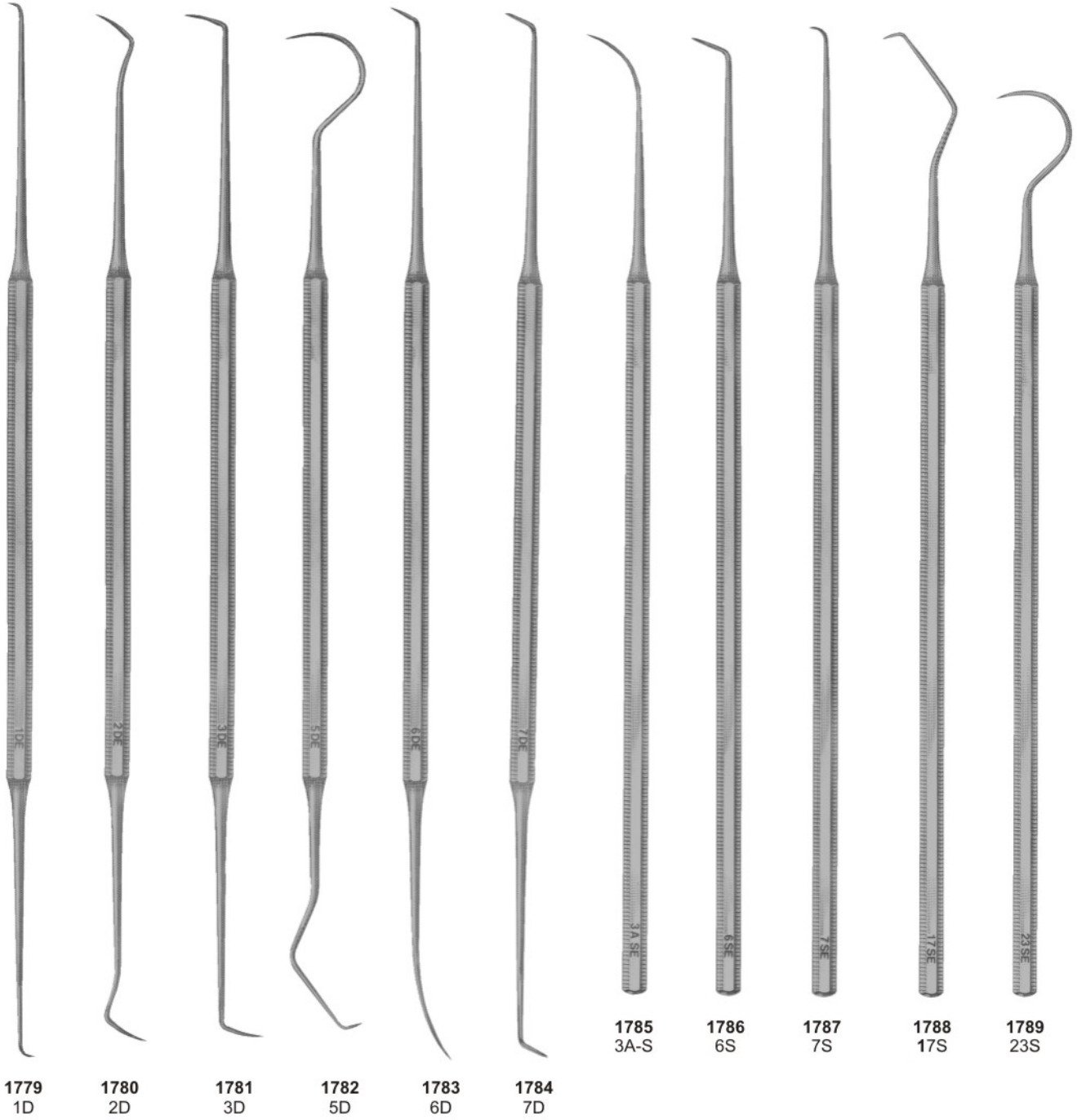

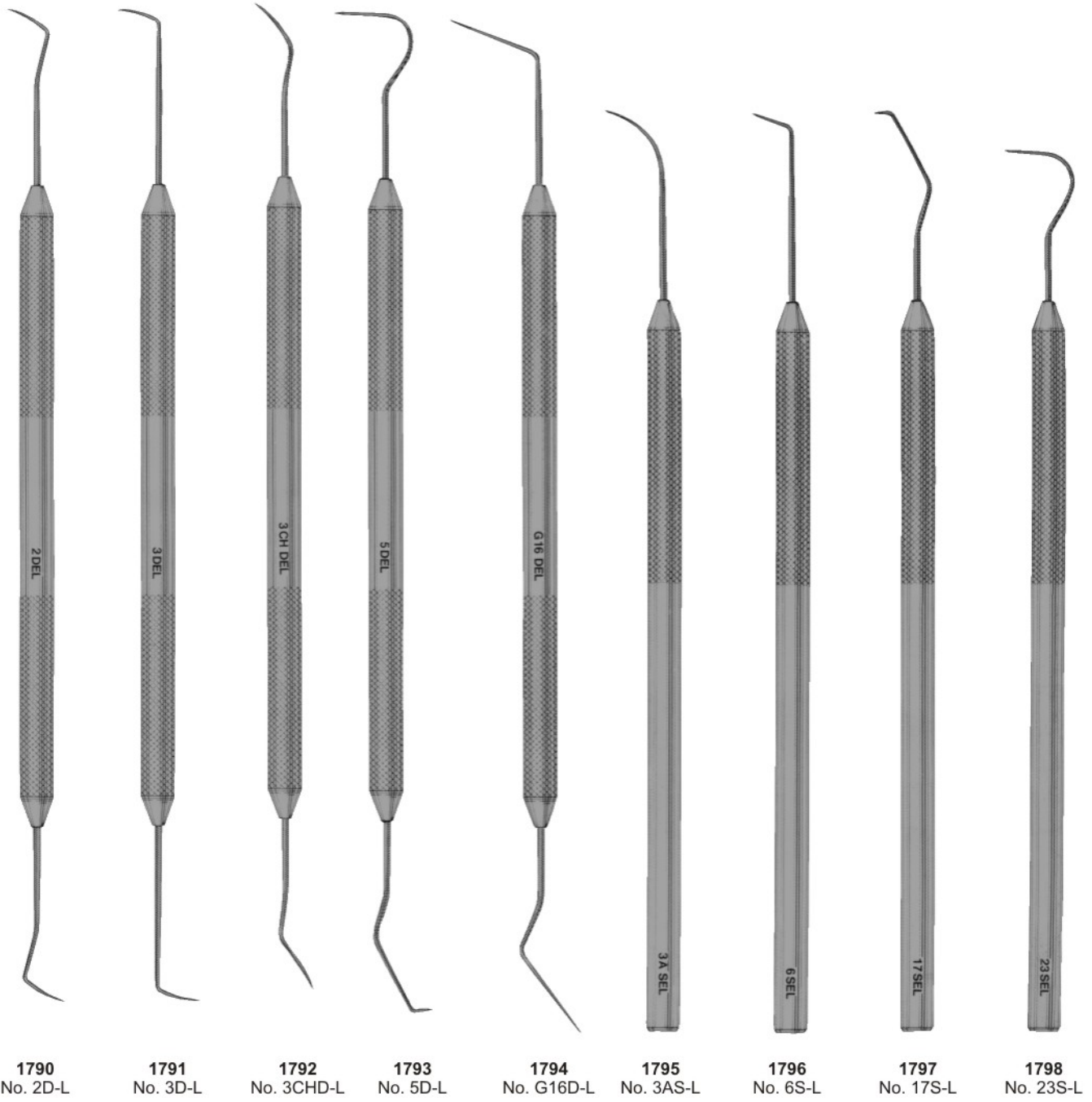

Explorer / Probe Combination

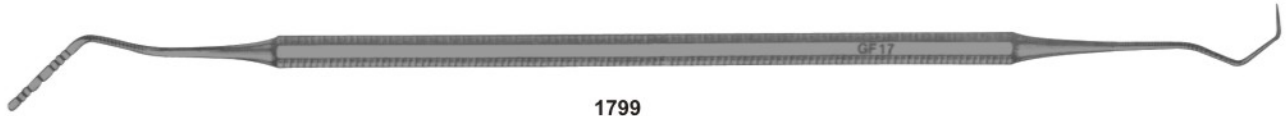

1799
Gf17 Probe/Explorer

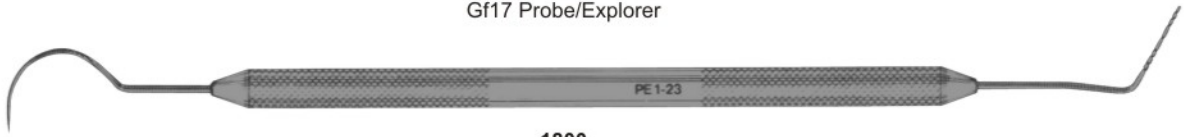

1800
PE 1-23 Probe/Explorer

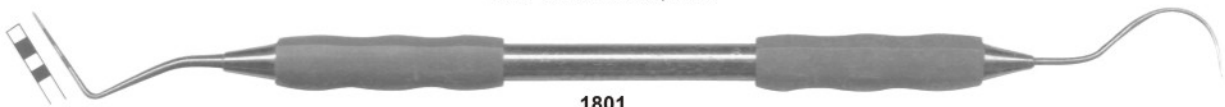

1801
Probe 0 / 23 Explorer (fine)

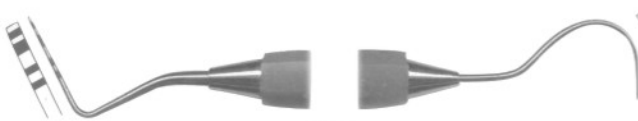

1802
Probe 1 / 23 Explorer



1804
Probe 4 / 23 Explorer



1803
Probe OW / 23 Explorer

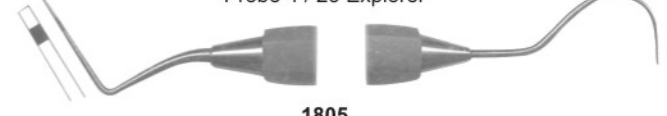

1805
Ball Tip Probe WHO / 23 Explorer

PROBES



1806
Gf18 Probe



1807
"C" Probe



1808
X2 Probe



1809
1-2 (Probe 2 end is flat)

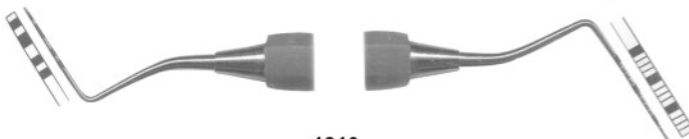

1810
1 UNC 15



1811
4 SE

CORD PACKERS



1812

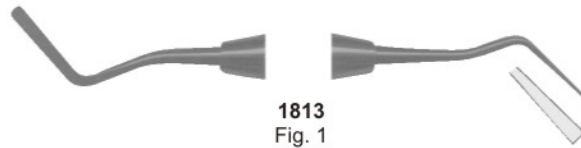

1813
Fig. 1



1814
Fig. 2



1815
BLOOMFIELD
Fig. 2 (off angle)



1816
Fig. 1



1817

CSI-1 (slightly serrated on ends)



HATCHETS



1818
1mm (10-7-14)



1819
1.3mm (13-10-16)



1820
1.5mm (15-8-14)



HOES



1821
1mm (10-8-16)



1822
UWH 18-19



1823
UWH 16-18



1824
UWH 20-21

P.K.Thomas waxing & Gracey Currettes Set



1825
P.K.Thomas 1



1826
P.K.Thomas 2



1827
P.K.Thomas 3



1828
P.K.Thomas 4



1829
P.K.Thomas 5



7001
Gracey Currettes Set of 7 Pcs, Silicon Handle - Reuseable

Amalgam Pluggers / Condensers / Applicators



1830
BEHRMAN (Fig. 1)



1831
BLACK (Fig. 1-2)



1832
MORQUETTE (Fig. 0/1)



1833
Black Action 11/12 Plugger



1834
Hollenback No.1 Plugger



1835
Hollenback No. 2 Plugger



1836
Hollenback No. 3 Plugger

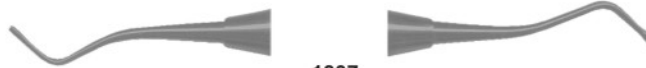

1837
Blacks 0-1 (1mm-1.5mm)



1838
Blacks 1-2 (1.5mm-2.5mm)



1843
.7mm-1mm



1839
Bodkin 1 (.7mm-1mm)



1844
1mm-1.5mm



1840
Bodkin 2 (1.5mm-2mm)



1845
1.5mm-2mm

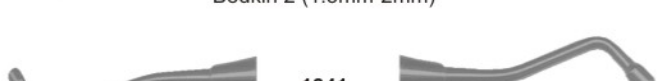

1841
2.5mm-3mm



1846
Oregon (Fig. 3)



1842
Oregon 2



1847
Oregon (Fig. 4)



1848
UP 12



1849
Applicator 1-2



1850
Birtles Applicator Spatula



1851
Birtles Applicator Spatula K

**Placement Instruments,
Stopping Stoppers, Pluggers**

Placement Instruments



1852
PICH (Calcium Hydroxide Placer)



1853
CA

Stopping Stoppers



1854
Woodson 2

Ø 1.6 mm

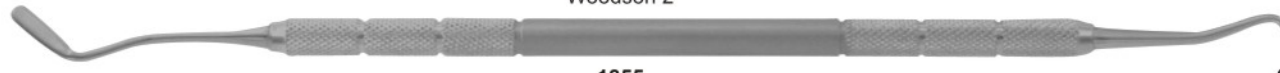

1855
Woodson 3S

Ø 2.4 mm

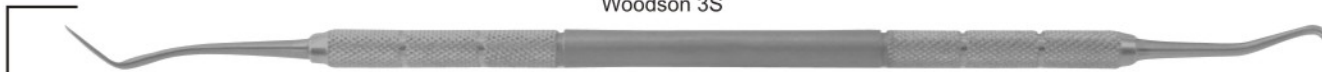

1856
Woodson 3A

Ø 2.6 mm



1857
Woodson 3

Ø 3.0 mm

Pluggers



Ø 0.75 mm

1858
Pluggers 0-1

Ø 1.2 mm

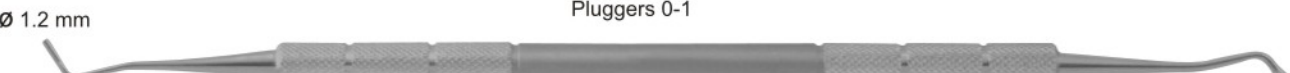

Ø 1.2 mm

1859
Pluggers 1-4

Ø 1.6 mm

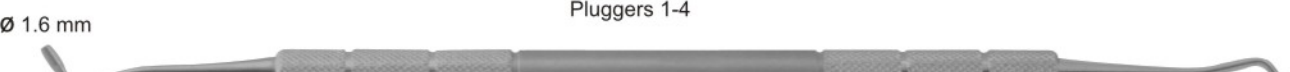

Ø 1.6 mm

1860
Pluggers 4-6

Ø 2.0 mm

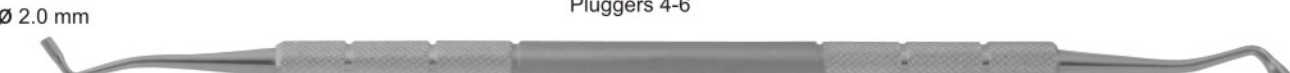

Ø 2.0 mm

1861
Pluggers 6-8

Ø 2.5 mm

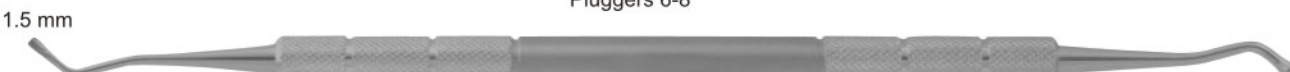

Ø 1.5 mm

1862
Black 1-2

Ø 2.6 mm

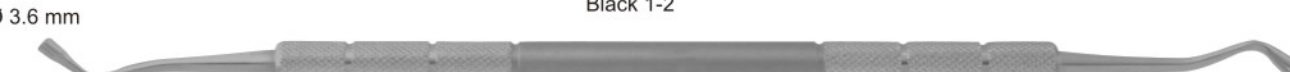

Ø 3.6 mm

1863
Black 2-3

Ø 5.0 mm

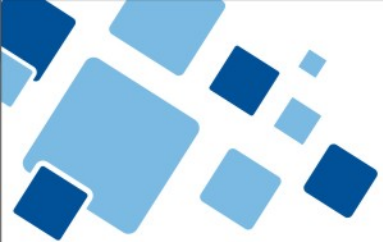

- ◊ Burnishers
- ◊ Carvers
- ◊ Chisels
- ◊ Composite Placements
- ◊ Filling Instruments
- ◊ Cures
- ◊ Disposable Instruments



03
SECTION



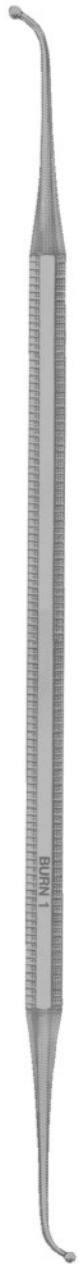

1864
Fig. 1

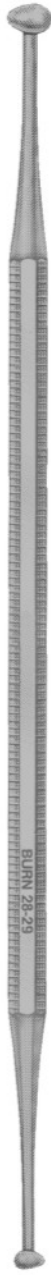

1865
Fig. 28/29



1866
Fig. 34



1867
Fig. 27/29

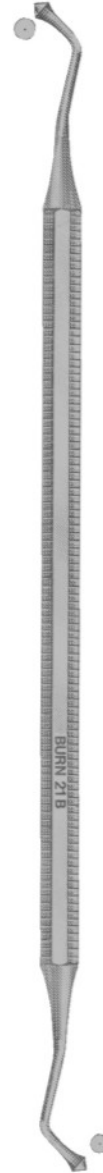

1868
Fig. 21B

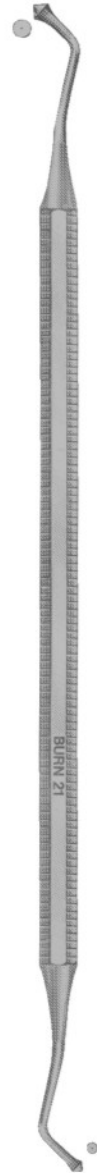

1869
ACORN
Fig. 21

Burnishers



1870
21 Acorn



1871
Fig. 21B



1873
Fig. 21C



1872
Fig. 2-34



1874
Fig. 26-28



1875
Fig. 2-30



1876
Fig. 26-30



1877
Fig. 27-29



1878
PKT 1



1879
Fig. 27-30



1881
Fig. 34T



1880
PKT 2



1882
Fig. 3



1883
PKT 3



1884
PFI 21



1885
PKT 3P



1886
Pitts Pedo 19



1887
PKT 4

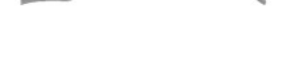

1888
Pitts Pedo 18



1889
PKT 5



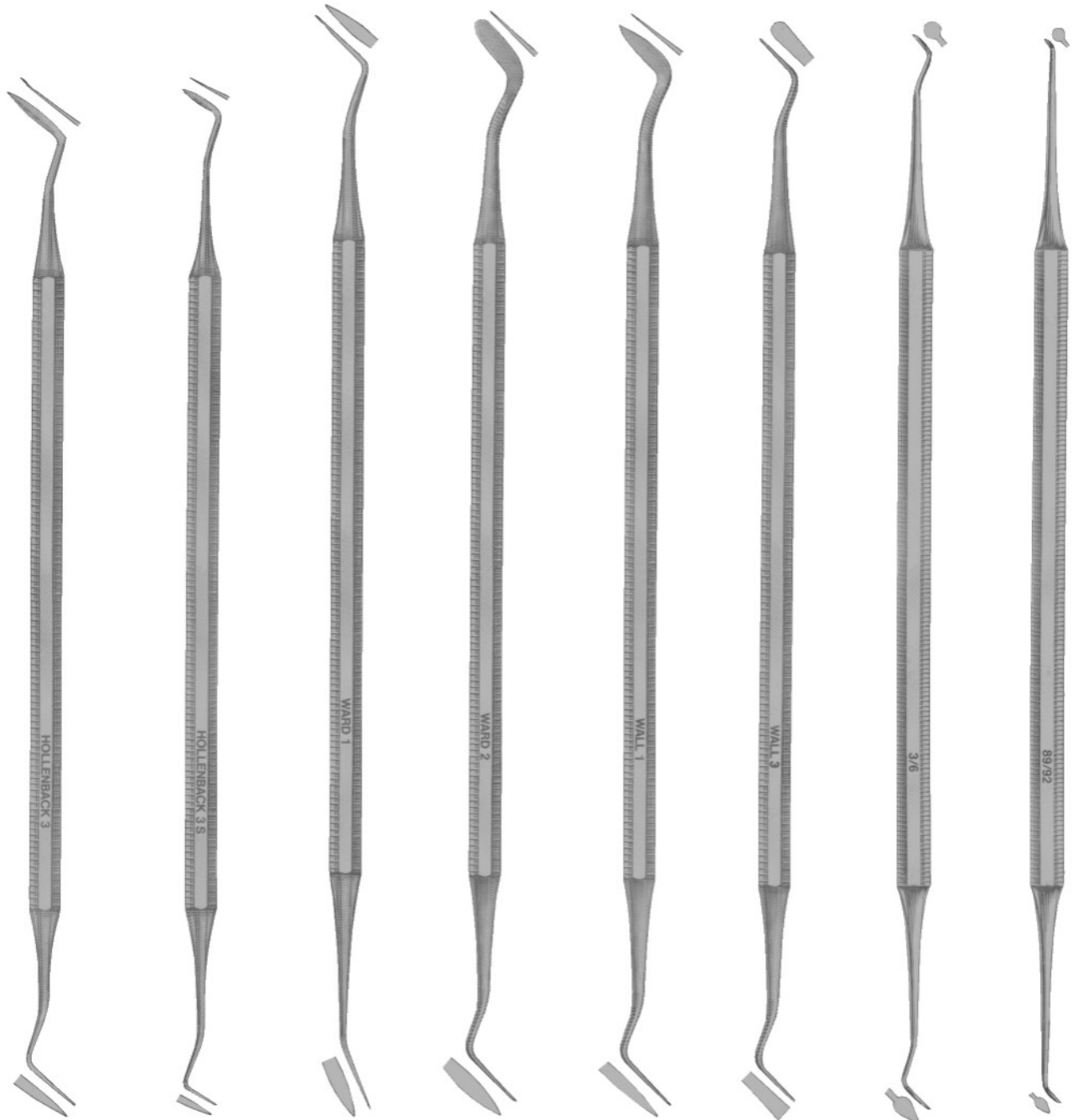

1890
HOLLENBACK
Fig. 3

1891
HOLLENBACK
Fig. 3S

1892
WARD
Fig. 1

1893
WARD
Fig. 2

1894
WALL
Fig. 1

1895
WALL
Fig. 3

1896
Fig. 3/6
Cleoid/Discoïd

1897
Fig. 89/92
Cleoid/Discoïd



1898
1.5mm Cleoid Discoid (Shown with GTX Finish)

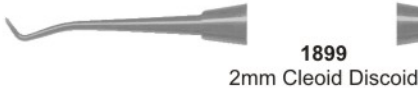

1899
2mm Cleoid Discoid



1900
GOLLOBIN
Fig. 1



1901
3mm Cleoid Discoid



1902
HOLLENBACK
Fig. 1/2



1903
FRAHM
Fig. 2-3 (off-angle)

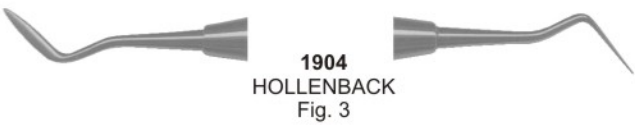

1904
HOLLENBACK
Fig. 3



1905
Interproximal 1



1906
THOMPSON (Fig. 3)
(½ Hollenback Hoe & Wall 3)



1907
Interproximal 1



1908
THOMPSON (Fig. 5)
(½ Hollenback Hoe & Tanner 5)



1909
Baum Interproximal



1910
THOMPSON (Fig. 8)
(3mm Cleoid & Wall 3)



1911
Sho A Carver



1912
THOMPSON (Fig. 9)
(Hollenback 3 & Wall 3)



1913
Thompson 2



1914
WARD
Fig. 2

Carvers, Chisels



1915
Composite Interproximal



1916
TANNER
Fig. 5



1917
TANNER
Fig. 6



1920
University of Minnesota
Fig. 1



1921
University of Minnesota
Fig. 2



1918
THARP
Fig. 1



1919
THOMPSON
Fig. 1



1922
UPR
Fig. 1



1923
WALL
Fig. 3

Contour Carbide Carvers - Finishing



1924
Contour Carbide (Fig. 1-2)



1925
Cleoid Discoid



1926
Contour Carbide (Fig. 10-11)

Chisels



1927
1.5mm Bin-Angle (15-8-8)



1928
1.5mm Straight (15)



1930
1.5mm Wedelstaedt (15-15-3)



1929
1mm Wedelstaedt (10-15-3)



1931
2mm Wedelstaedt (20-15-3)

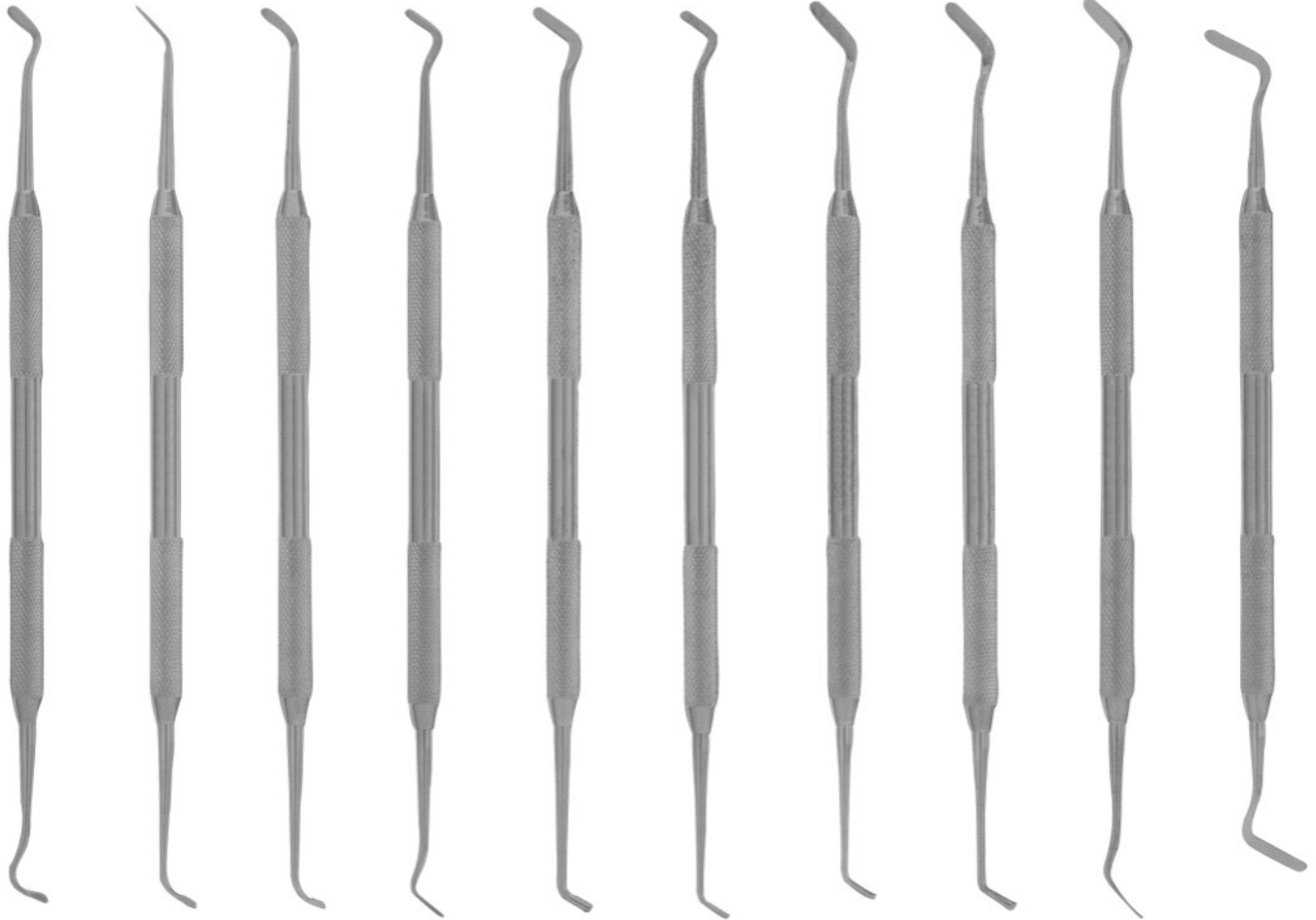

1932
F-Type 1

1933
F-Type 2

1934
F-Type 3

1935
F-Type 4

1936
F-Type 5

1937
F-Type 6

1938
G-Type 1

1939
G-Type 2

1940
G-Type 3

1941
G-Type 4

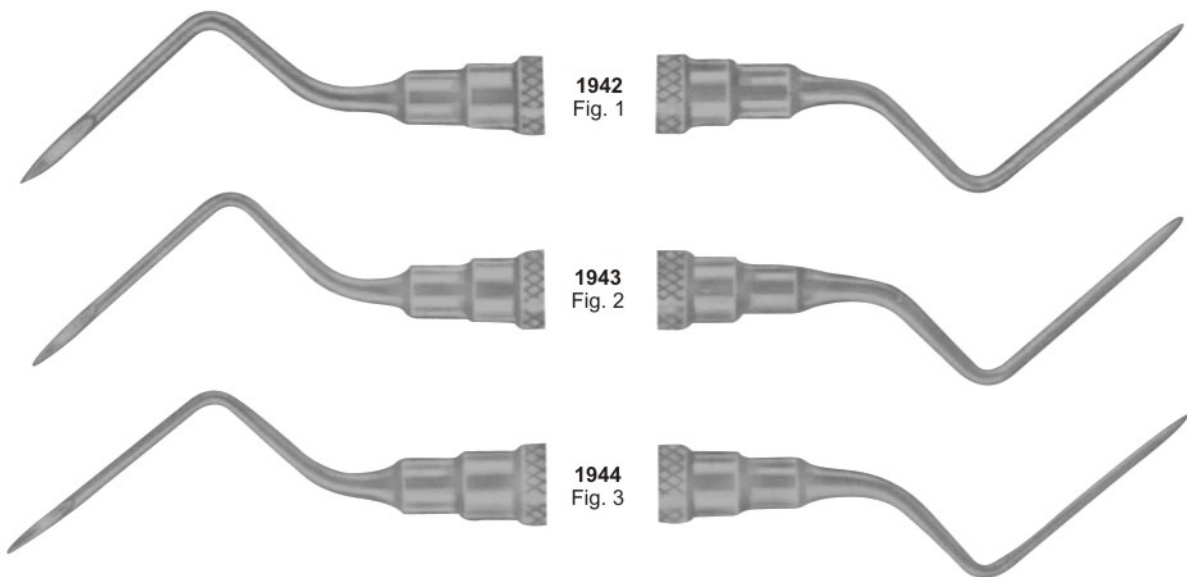

1942
Fig. 1

1943
Fig. 2

1944
Fig. 3

Composite Placement



1945
Fig. 2



1946
Fig. 3 (off-set blade)



1947
Fig. 4



1948
Fig. 5

1954
Fig.12



1949
Fig. 6



1950
Fig.7



1951
Fig.8

1955
Fig.15



1952
Fig.9



1953
Fig.11



1956
JORDAN
Fig. 2



1957
FREEDMAN
Fig. 1



1958
FREEDMAN
Fig. 2



1959
FREEDMAN
Fig. 3



1960
Dr. Dan



1961
SIMON
Fig. 2



K - Type

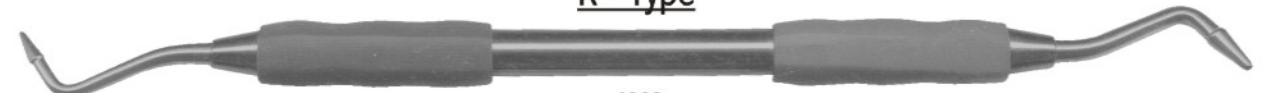

1962
K-Type 1

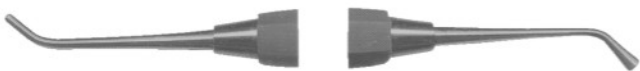

1963
K-Type 2



1965
K-Type 4



1964
K-Type 3



1966
K-Type 5



1967
K-Type 6 Carbide

Plastic Filling Instruments

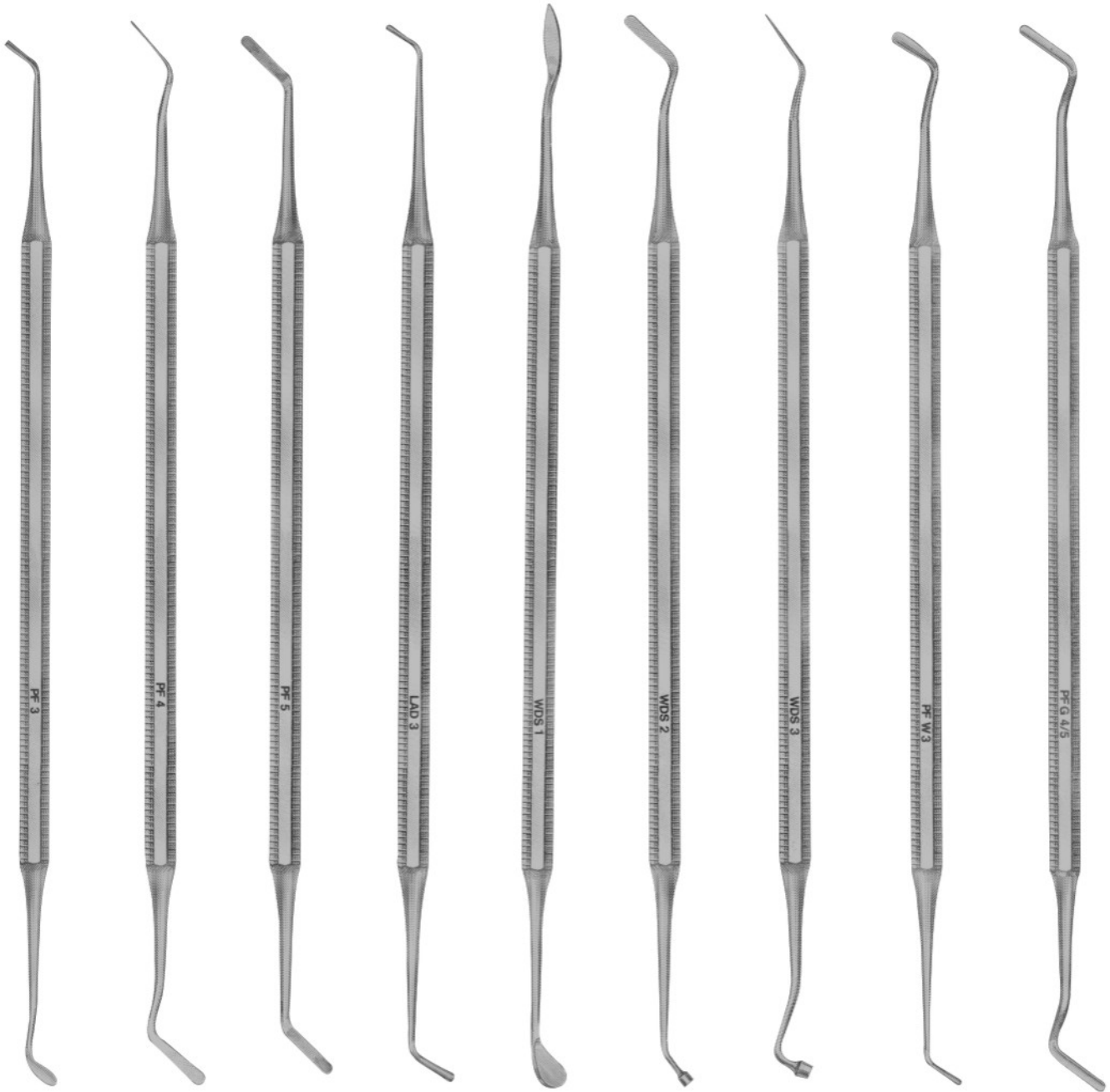

1968
No.3

1969
No.4

1970
No.5

1971
LADMORE
Fig. 3

1972
WOODSON
Fig. 1

1973
WOODSON
Fig. 2

1974
WOODSON
Fig. 3

1975
W-3

1976
Gregg
4/5



1977
Fig. 5-7



1978
Fig.1



1979
Fig. 3



1983
GLICK
Fig.1



1980
Fig. 4



1984
P8



1981
Fig. 5-7



1985
WOODSON
Fig. 1



1982
Fig. 8A



1986
WOODSON
Fig. 2



1987
WOODSON
Fig. 3





1988
GRACEY
GC 1-2



1989
GRACEY
GC 3-4



1990
GRACEY
GC 5-6



1991
GRACEY
GC 7-8



1992
GRACEY
GC 9-10



1993
GRACEY
GC 11-12



1994
GRACEY
GC 13-14

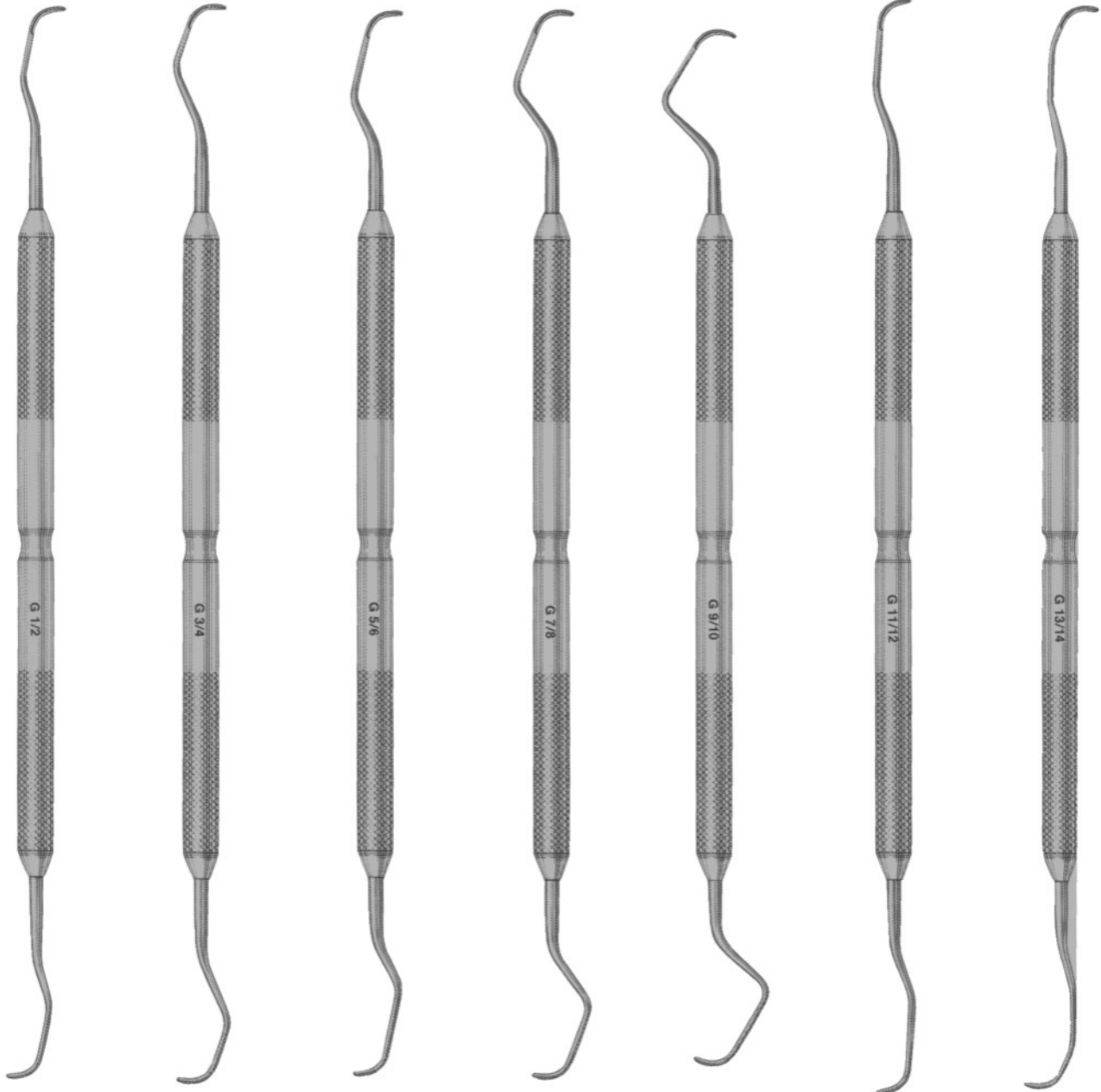

1995
G1-2

1996
G3-4

1997
G5-6

1998
G7-8

1999
G9-10

2000
G11-12

2001
G13-14

Curettes # 4 Handle

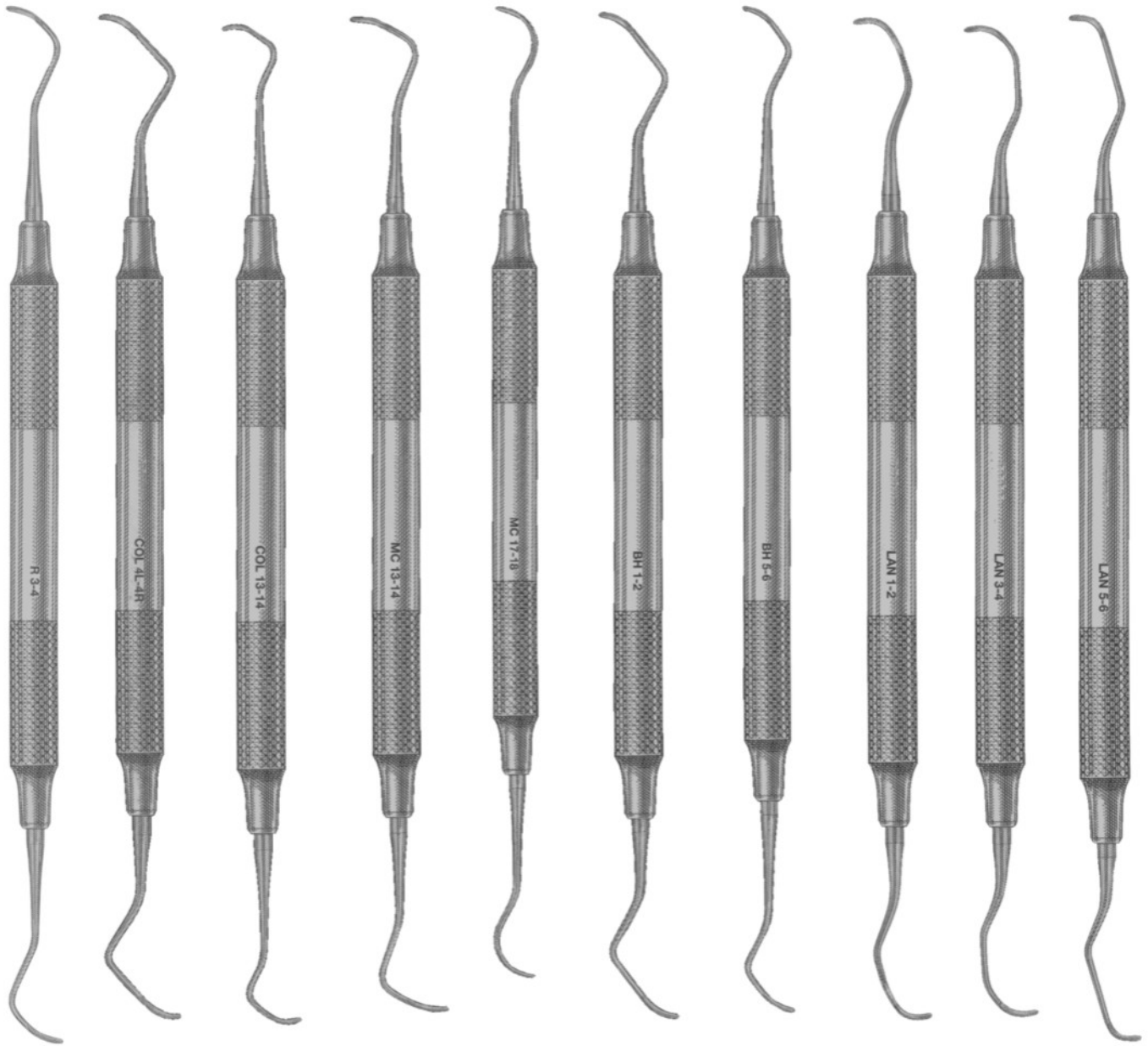

2002
RULE
3-4

2003
COLUMBIA
4R-4L

2004
COLUMBIA
13-14

2005
MCCALLS
13-14

2006
MCCALLS
17-18

2007
BARNHART
1-2

2008
BARNHART
5-6

2009
LANGER
1-2

2010
LANGER
3-4

2011
LANGER
5-6

COLUMBIA CURETTES



2012
4L-4R

2013
13-14

2014
2L-2R

MCCALLS CURETTES



2015
13-14

2016
13S-14S

2017
17-18

2018
17S-18S

GOLDMAN FOX



2019
GF1 Universal Scaler



2020
GF2 Curette



2021
GF3 Curette



2022
GF4 Curette



2023
GF5 Hoe



2024
GF6 Hoe

GOLDMAN FOX



2025
GF 7 Knife



2026
GF 8 Spear Knife

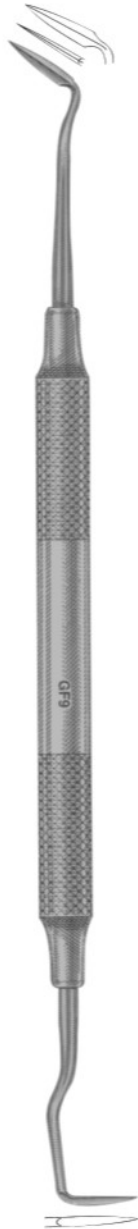

2027
GF 9 Knife Scaler



2028
GF 11 Spear Knife



2029
GF 21 Sharp Spoon /
Small Scaler

Knives, Interproximal Files



2030
Kirkland 15 / 16



2031
Ordan 1 / 2



2032
Buck 3 / 4

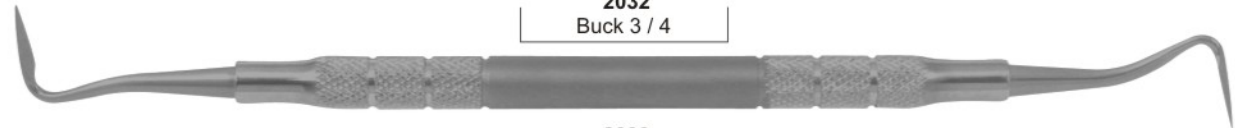

2033
Buck 5 / 6



2034
Goldman-Fox 7



2035
Goldman-Fox 8



2036
Goldman-Fox 9

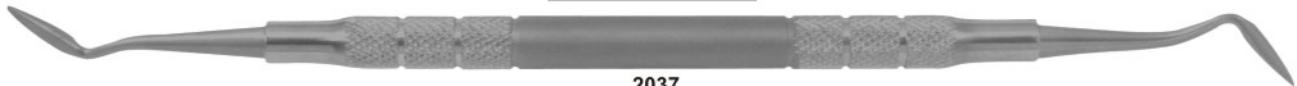

2037
Goldman-Fox 11



2038
CK 3 (Crane)

Interproximal Files

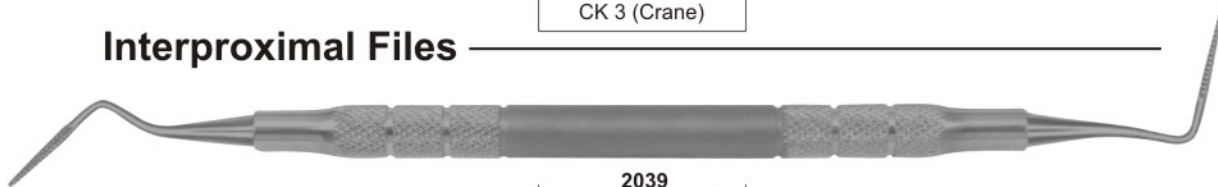

2039
Sugarman 1S-2S

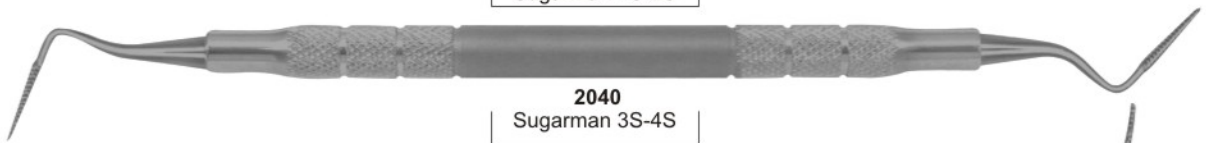

2040
Sugarman 3S-4S

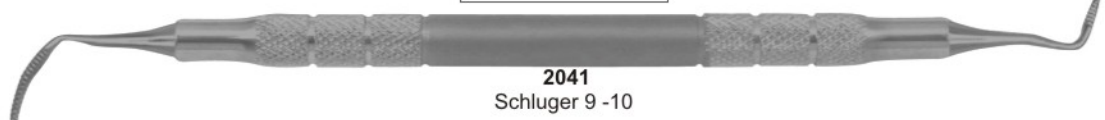

2041
Schluger 9 -10



2042
Buck 11 - 12

Curettes, Root Planning Curettes



2043
COLUMBIA (2L-2R)



2044
MCCALL (13-14)



2045
MCCALL (17S-18S)

Root Planning Curettes

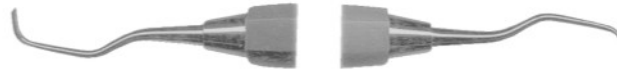

2046
Root Plane (1-2)



2047
Root Plane (5-6)

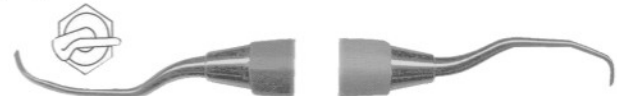

2049
Root Plane (11-12)



2048
Root Plane (7-8)

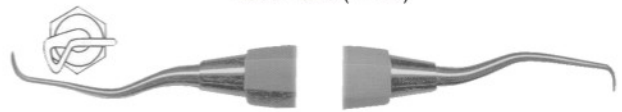

2050
Root Plane (13-14)



2051
Petite (1-2)



2052
Petite (11-12)

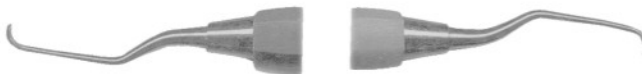

2053
Petite (5-6)



2054
Petite (13-14)



2055
BARNHART (1-2)



2056
BARNHART (5-6)

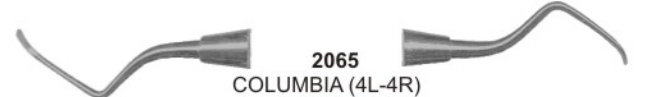

2065
COLUMBIA (4L-4R)



2057
GRACEY (1-2)



2066
COLUMBIA (13-14)



2058
GRACEY (3-4)



2067
LANGER (1-2)



2059
GRACEY (5-6)



2068
LANGER (3-4)



2060
GRACEY (7-8)



2069
LANGER (5-6)



2061
GRACEY (9-10)



2070
MCCALL (13-14)



2062
GRACEY (11-12)

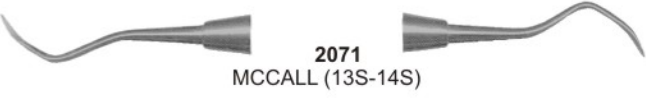

2071
MCCALL (13S-14S)



2063
GRACEY (13-14)



2072
MCCALL (17-18)

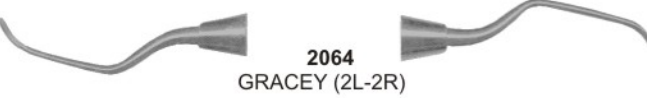

2064
GRACEY (2L-2R)



2073
MCCALL (17S-18S)



2074
RULE (3-4)



- ⟨☞⟩ Cement Instruments
- ⟨☞⟩ Bone Chisels
- ⟨☞⟩ Spatulas
- ⟨☞⟩ Bone Mallets
- ⟨☞⟩ Knives
- ⟨☞⟩ Crown Remover
- ⟨☞⟩ Bone Currettes & Files
- ⟨☞⟩ Implant Instruments



04

SECTION



Silicon Handles-Reusable

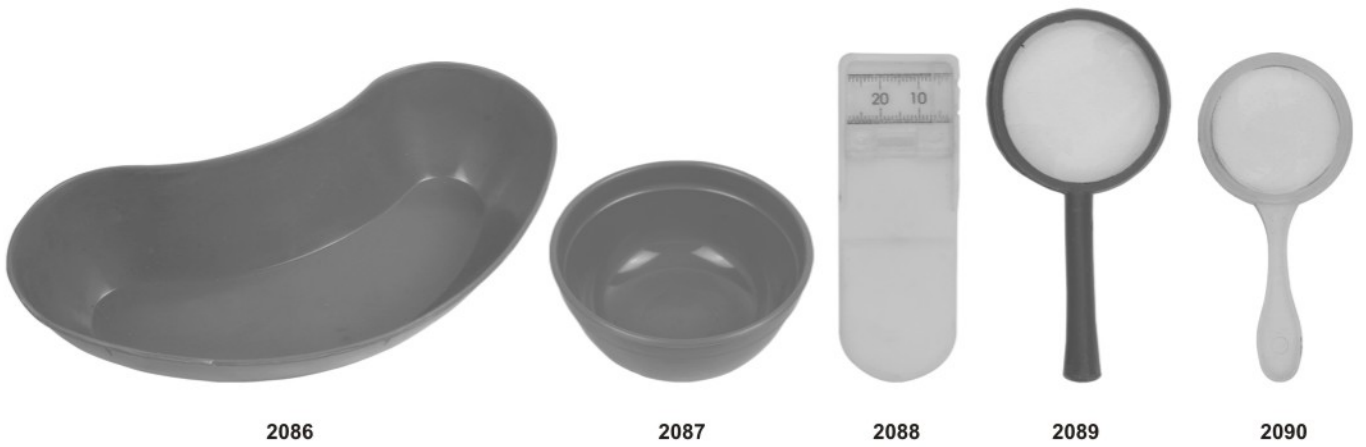
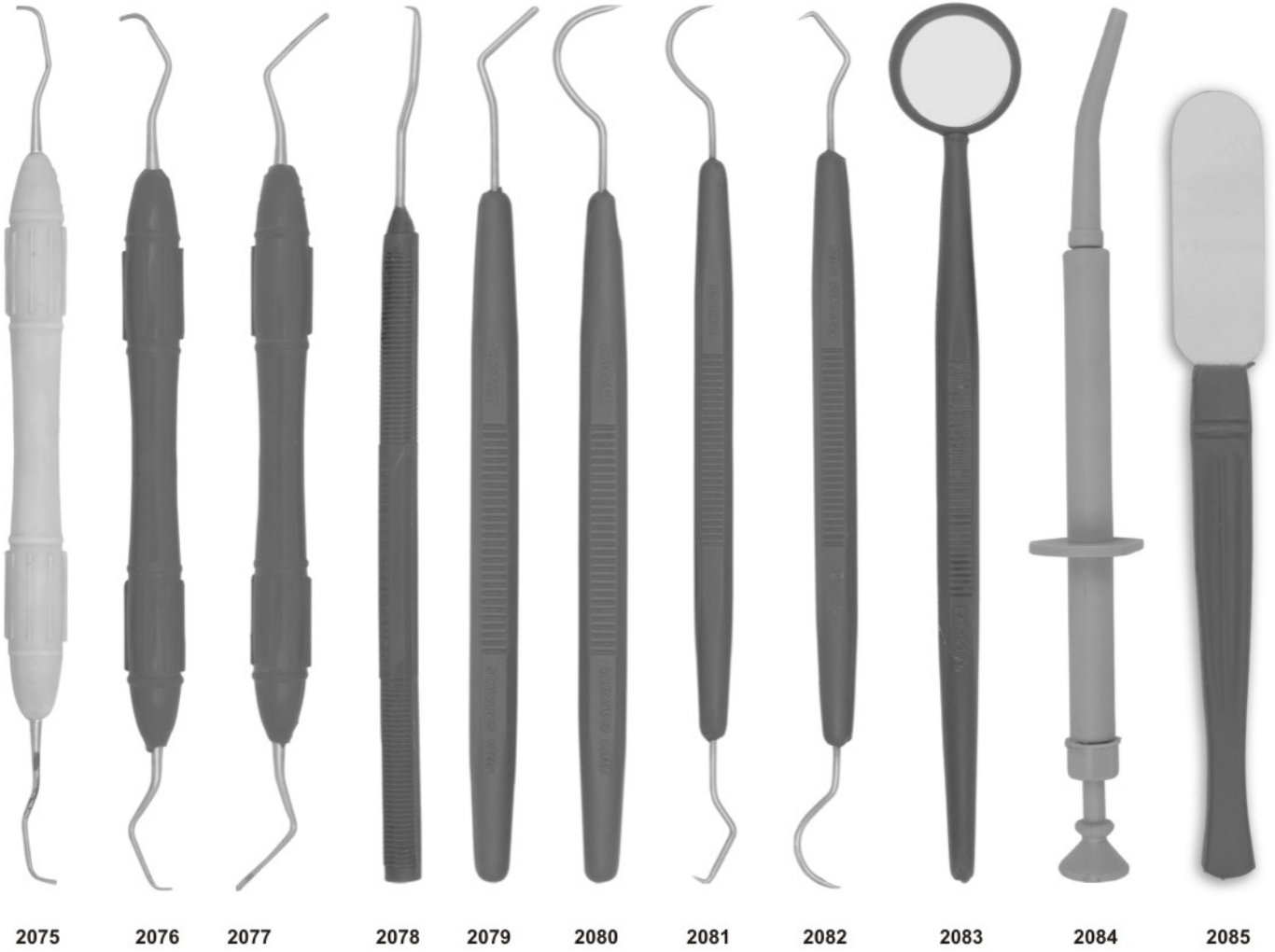

Comfort Grip
Vinyl - Covered Insulating Handles

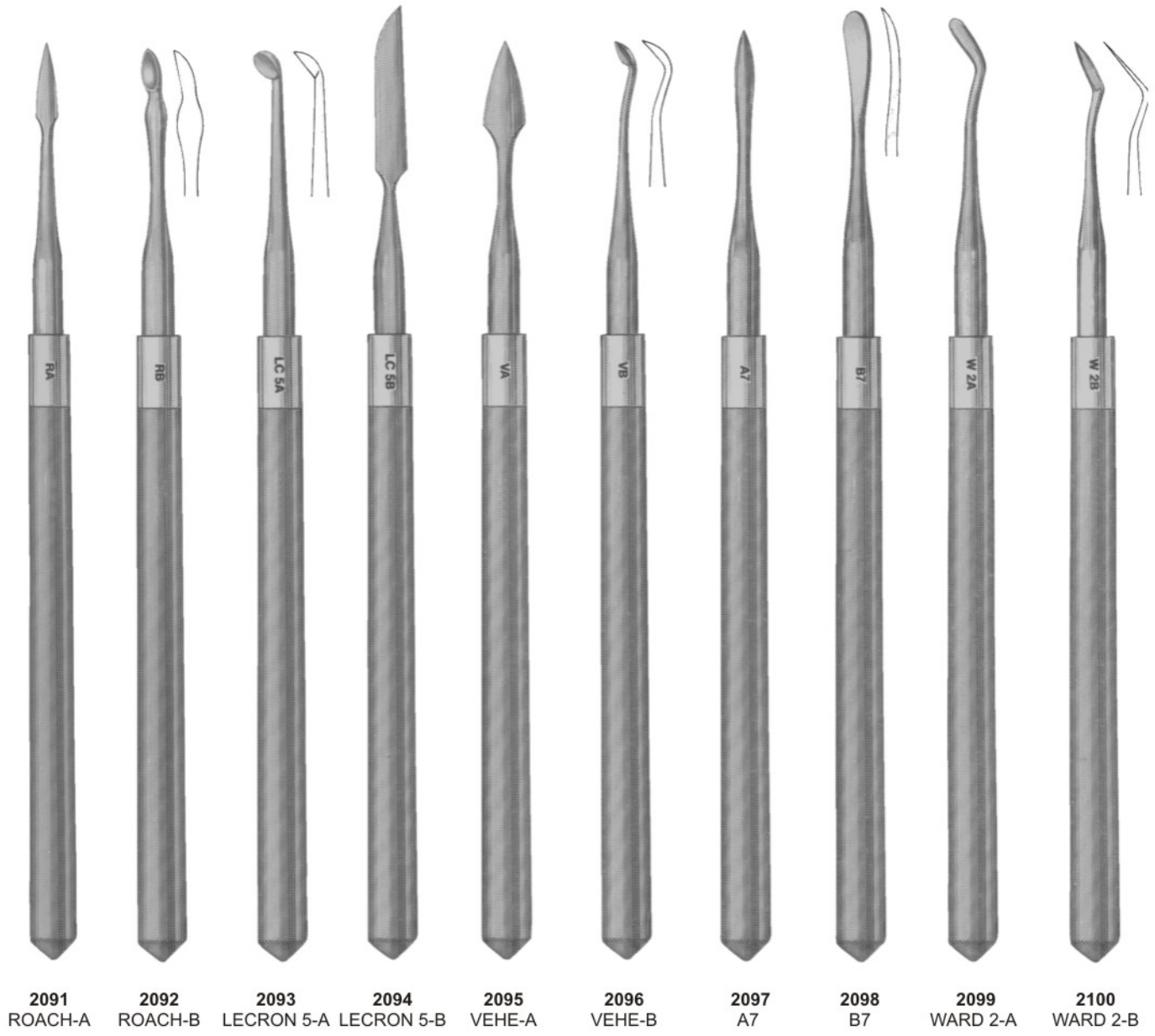

2091 ROACH-A 2092 ROACH-B 2093 LECRON 5-A 2094 LECRON 5-B 2095 VEHE-A 2096 VEHE-B 2097 A7 2098 B7 2099 WARD 2-A 2100 WARD 2-B



**Wax, Porcelain &
Cement Instruments**

P.K. THOMAS

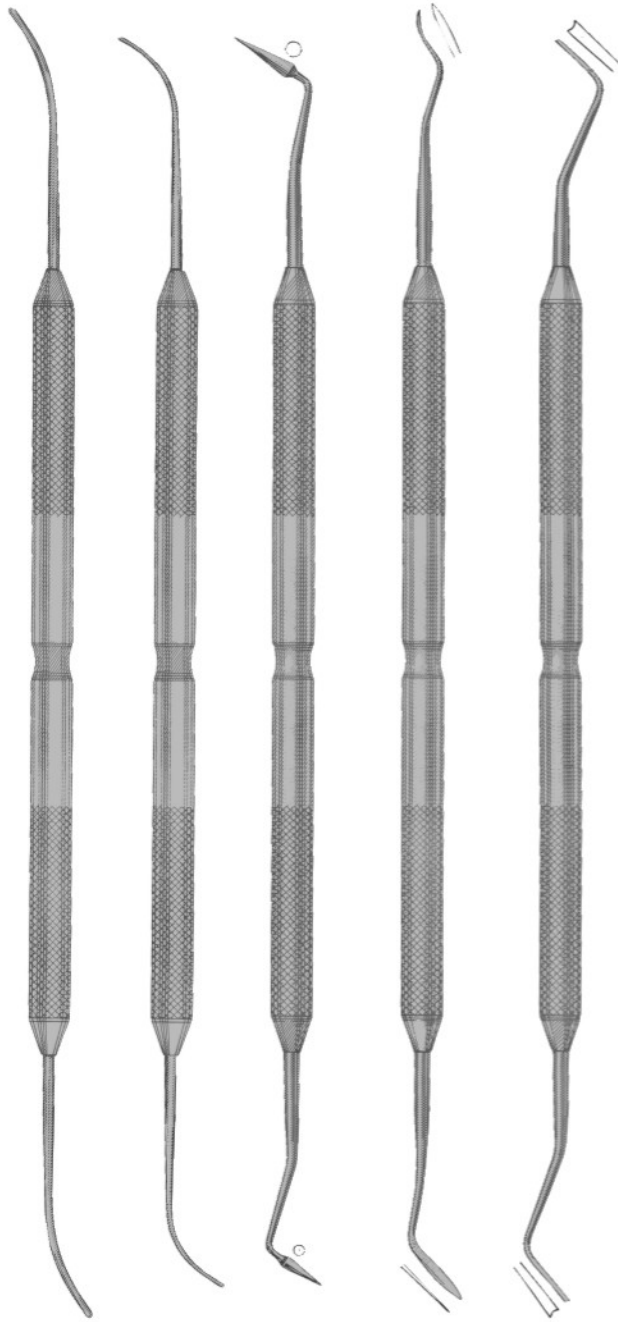

2101 PKT 1 2102 PKT 2 2103 PKT 3 2104 PKT 4 2105 PKT 5

Set of 5 instruments

WAX CARVERS

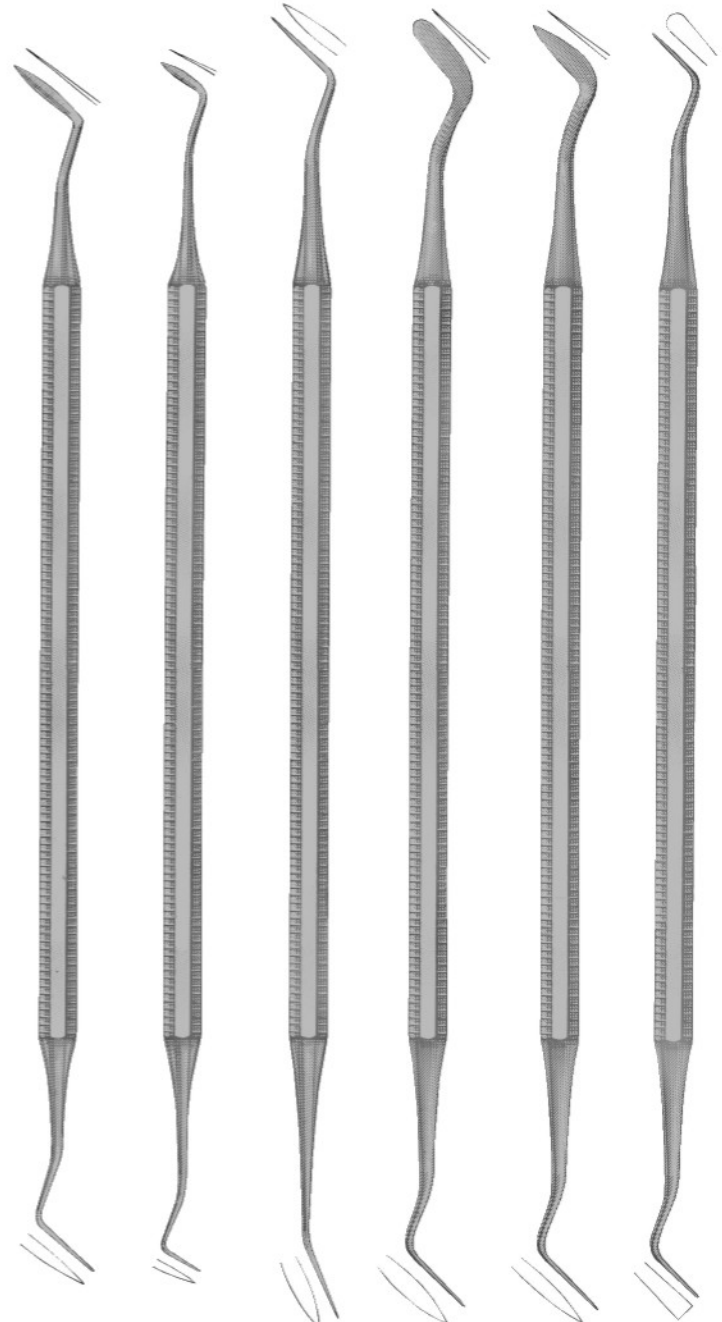

2106 Hollenback 3 2107 Hollenback 3S 2108 WARD 1 2109 WARD 2 2110 WALL 1 2111 WALL 3

Wax & Modeling Carvers, Cement Spatulas

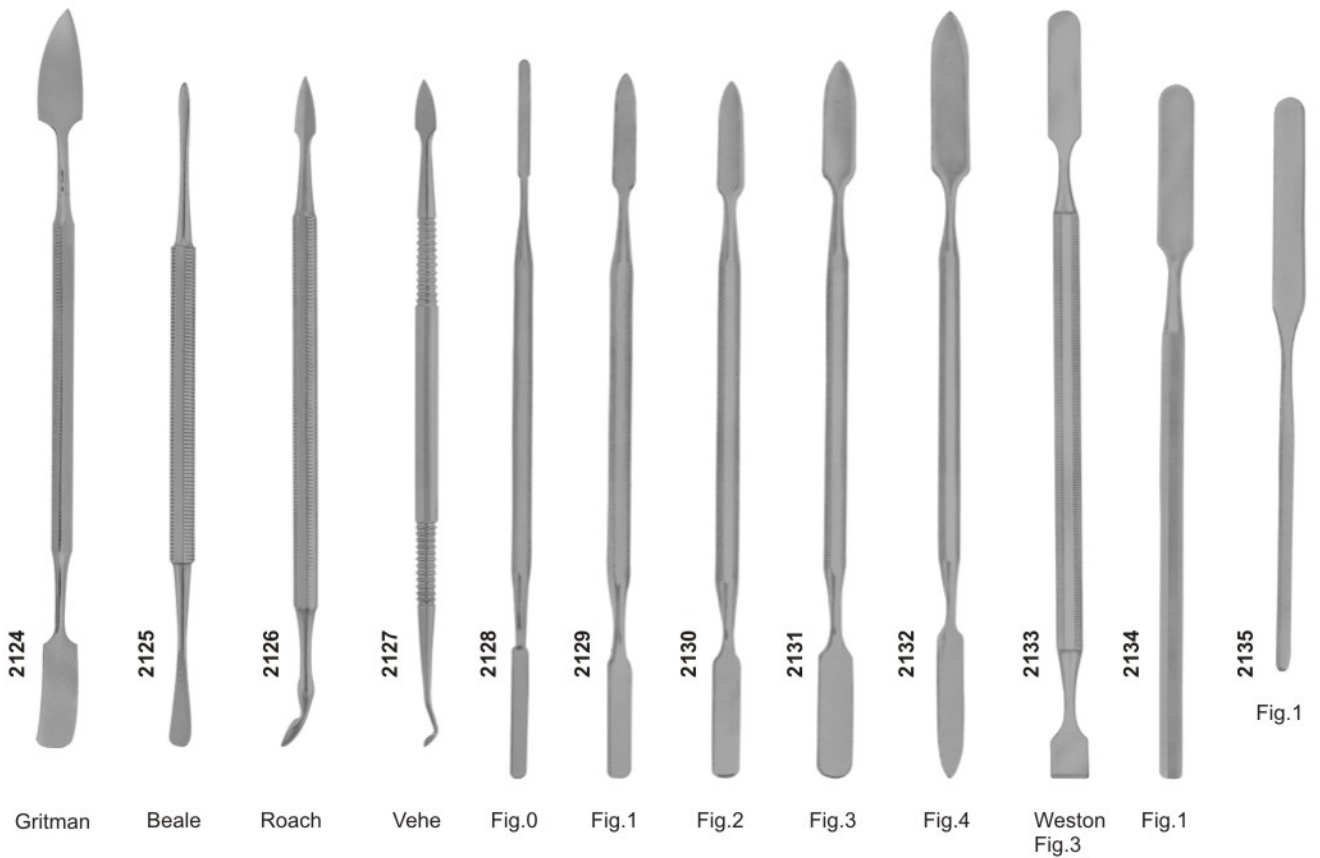
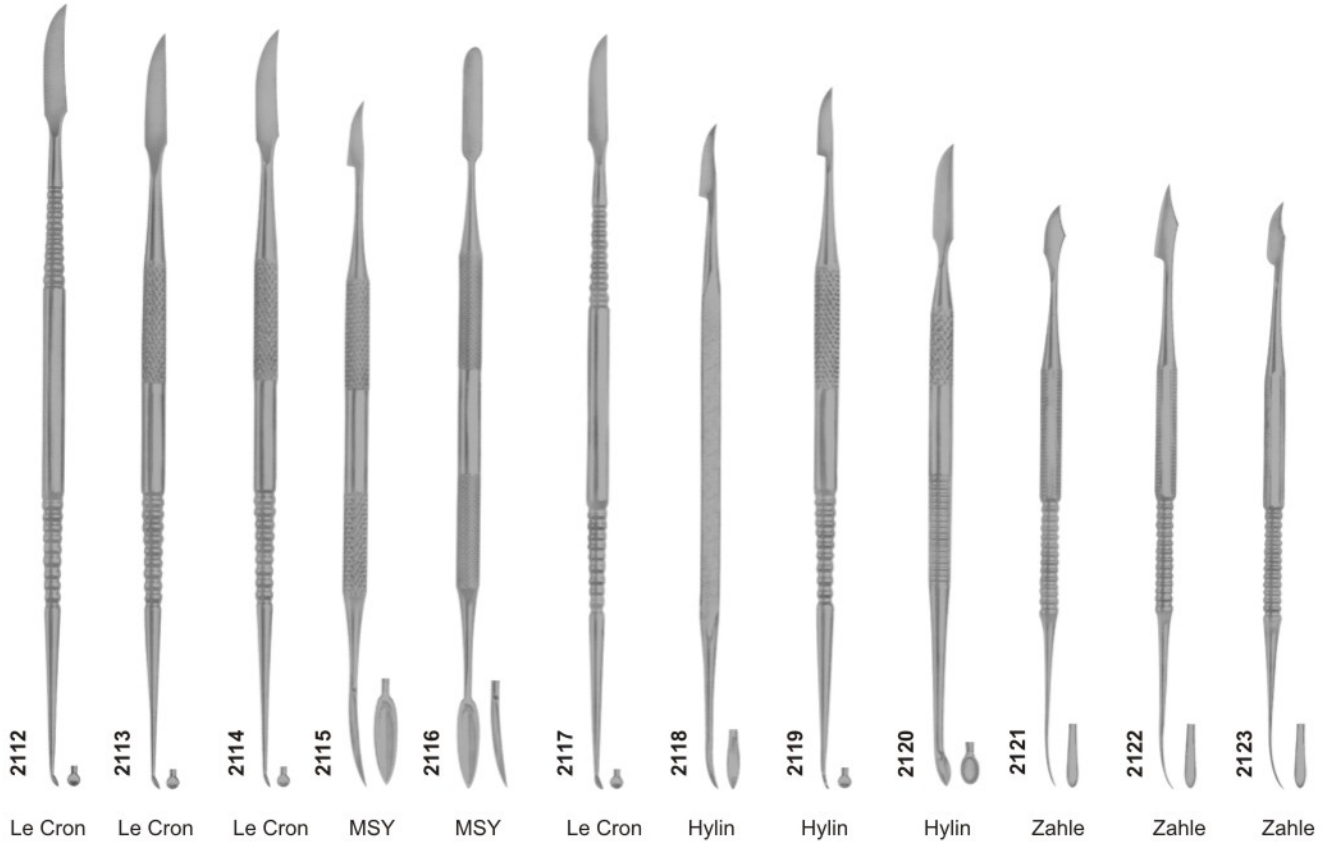

**Wax, Porcelain &
Cement Instruments**

WAX & PORCELAINE CARVERS

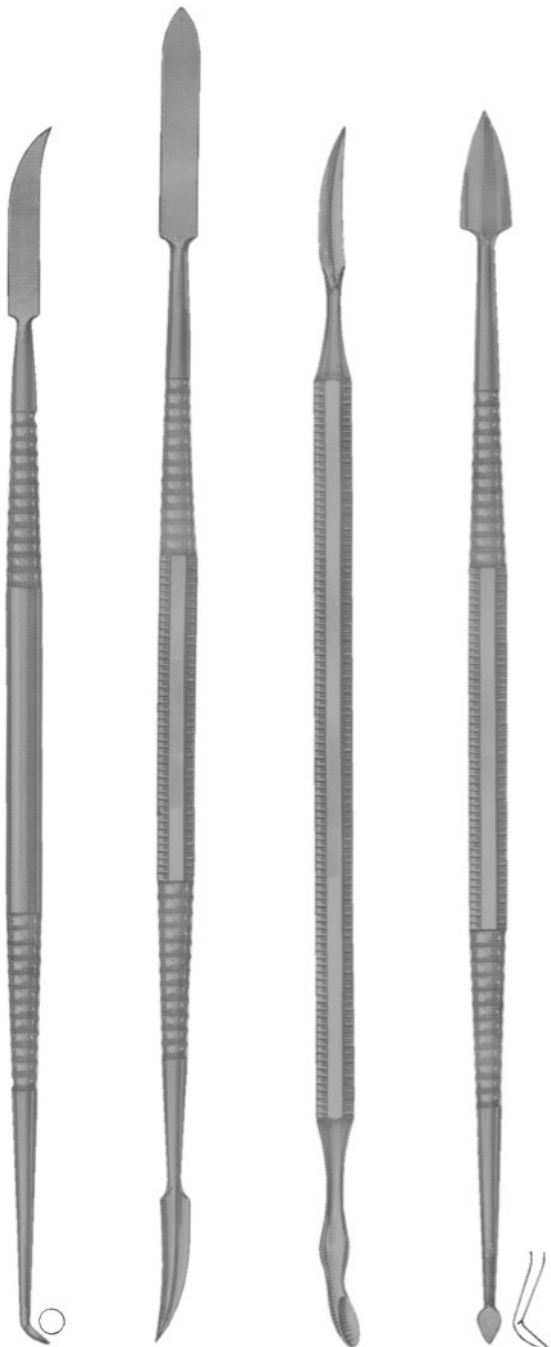

2136
LECRON
Inlay

2137
REEVES

2138
VEHE
Wax

2139
ROACH
Wax

WAX SPATULAS

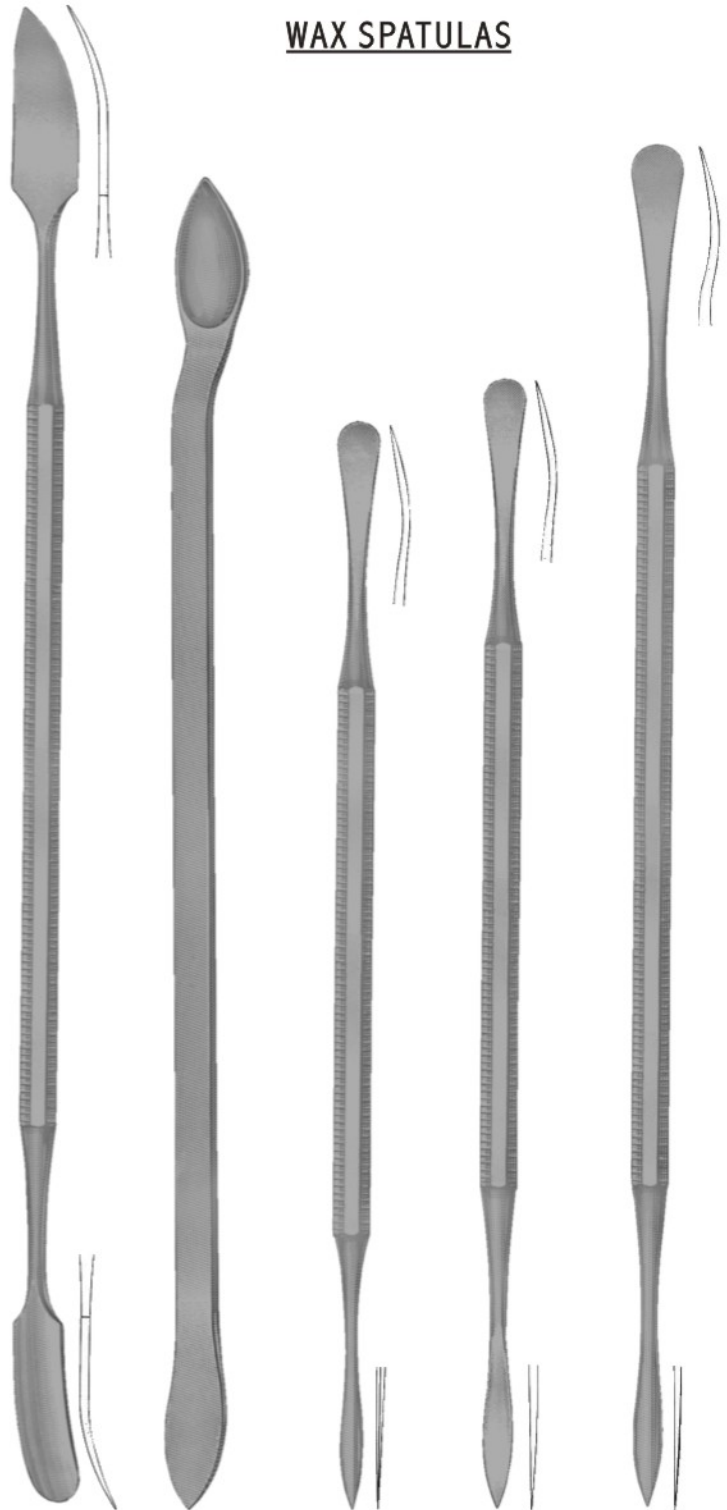

2140
W-31

2141
W-5

2142
W-7

2143
W-7A

2144
W-7G



2145
AGATHE



2146
C-7



2147
C-5



2148
C-313



2149
C-24A Rigid



2150
C-24 Flexible



2151
C-24 Flexible



2152
24



2153
A6



2154
7 Wax



2155
26



2156
All Metal Spatulas with High Polish
Stainless Steel Blade



2157
31

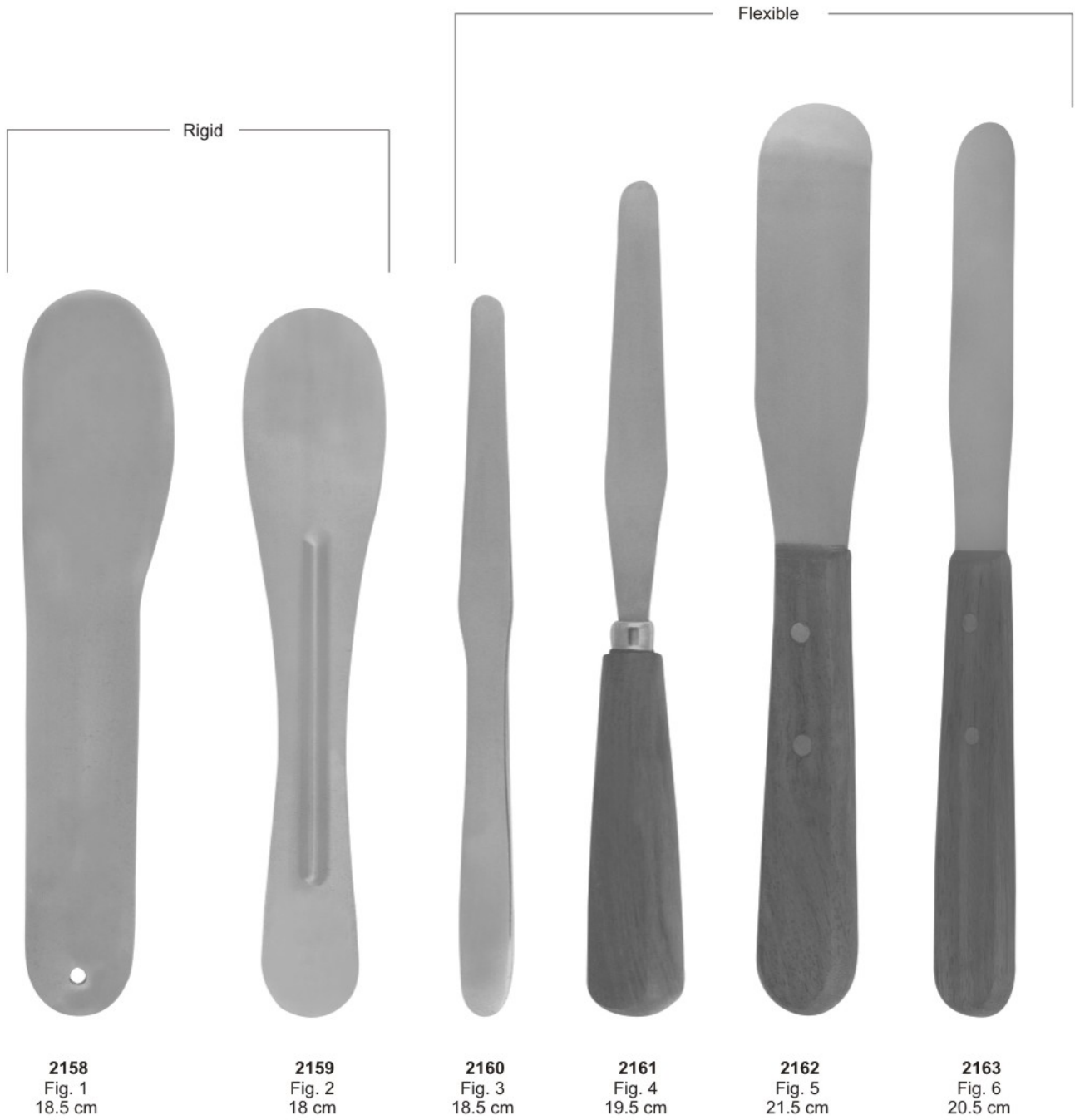

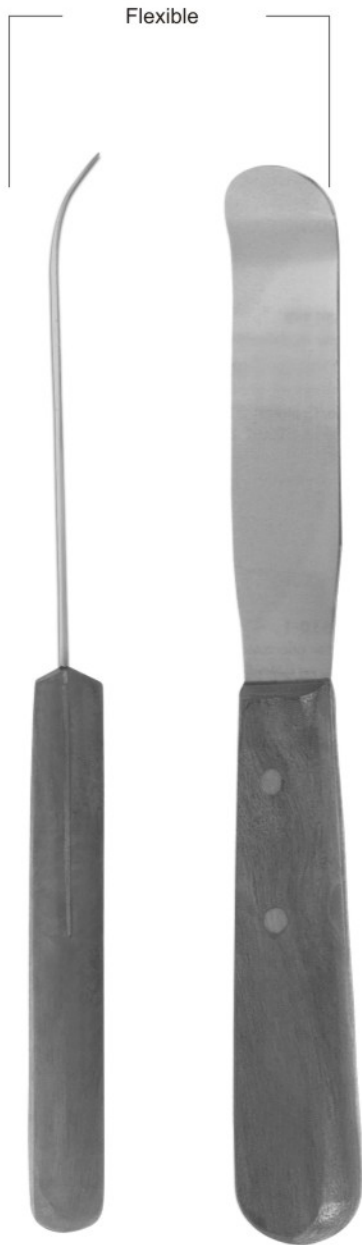

2164
Fig. 7
19.5 cm



2165
Fig. 8
20 cm

2166
Fig. 9
22.5 cm

FILES



2167
Hirshfeld 3-7



2168
Hirshfeld 5-11



2169
Hirshfeld 9-10

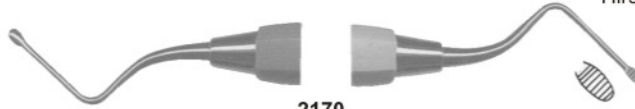

2170
Orban 10-11

HOES



2171
Orban 6-7

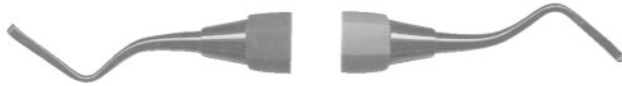

2172
Orban 8-9



2173
UWH 18-19



2174
UWH 16-18



2175
UWH 20-21



2176

KNIVES



2177
Orban Knife (1-2)



2178
1 SE



2179
2-3

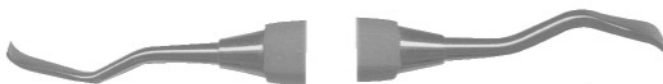

2180
Kirkland 13-13L

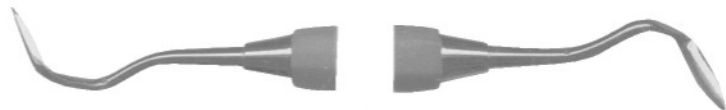

2181
Knife Orban 1-2 TT DEO



2182
Fahnenstock
Fig. 1
12,5cm

2183
Fahnenstock
Fig. 2
17cm

2184
Lessmann
Fig. 1
12,5cm

2185
Lessmann
Fig. 2
17cm

2186
Con scodellino
Fig. 1
12,5cm

2187
Con scodellino
Fig. 2
17cm

2188
Ermert

2189
Ermert



Wax Knives & Plaster Knives



2190
18 cm
7 1/8"



2191
18 cm
7 1/8"



2192
17 cm
6 3/4"
Gritman



2193
17 cm
6 3/4"
Medicon



2194
Fig. 1
17 cm



2195
22 cm
8 3/4"



2196
22 cm
8 3/4"



2197
Gritman
Fig. 2
17 cm



2198
Fig. 3
16 cm



2199
Fig. 4
16 cm

Crane-Kaplan, Chisels

CRANE-KAPLAN

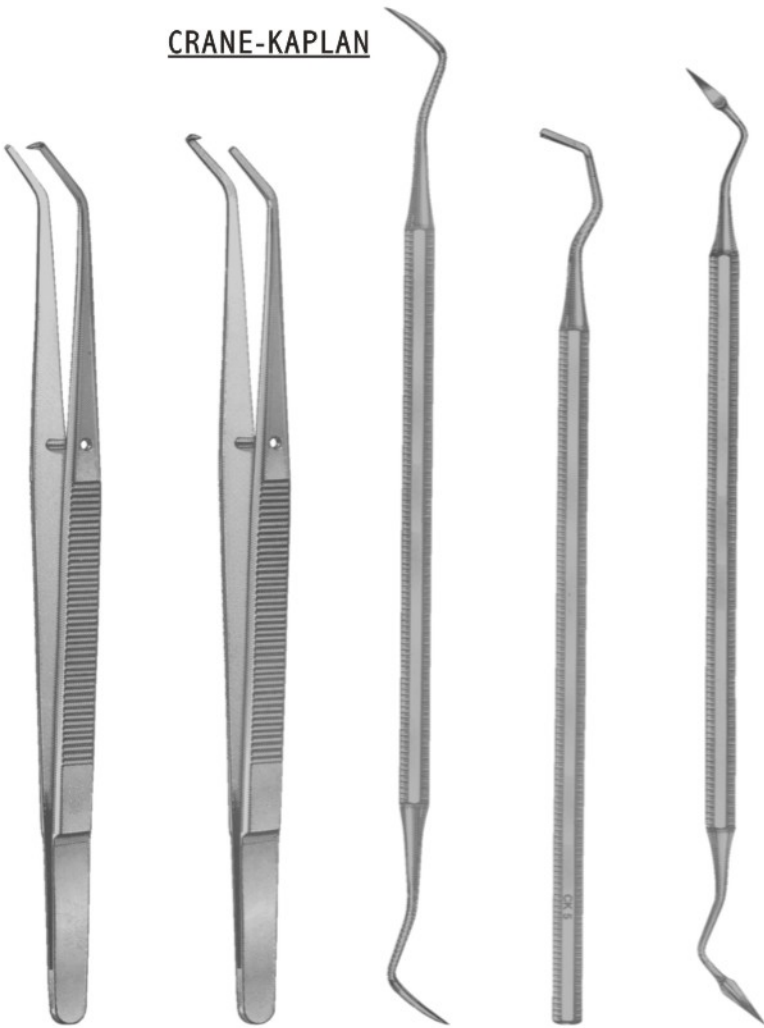

2200
Ck1
Pocket Marker

2201
Ck2
Pocket Marker

2202
Knife

2203
Dissector

2204
Scaler

OCHSENBEIN

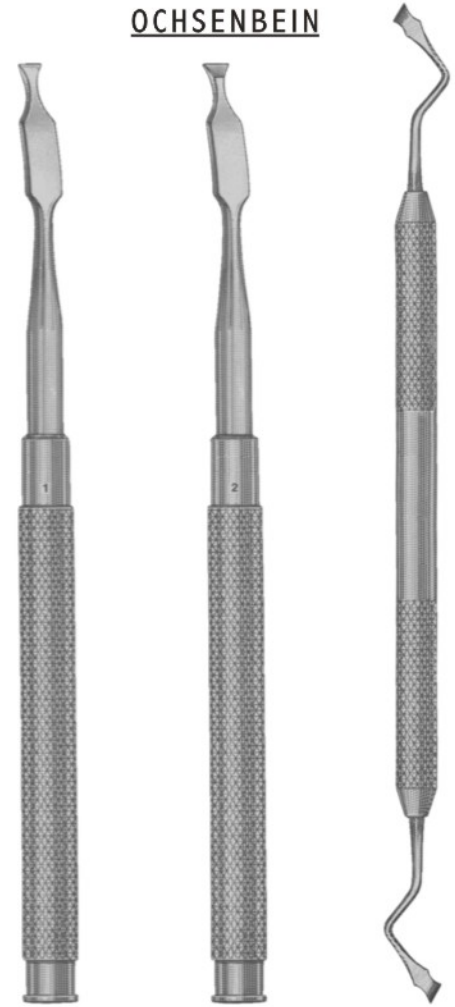

2205
Ochsenbein
Fig. 1

2206
Ochsenbein
Fig. 2

2207
Ochsenbein
Fig. 4

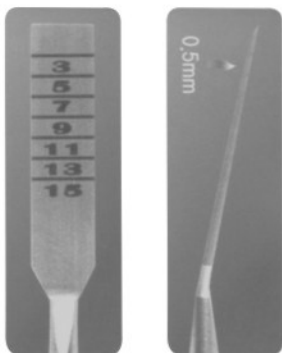

Split Chisel Set



2208
Split Chisel
6 mm Curved



2209
Split Chisel
6 mm Straight

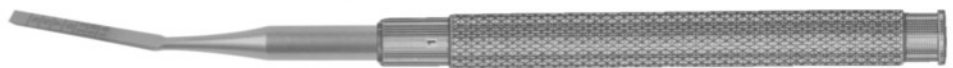

2210
Split Chisel
4 mm Curved



2211
Split Chisel
4 mm Straight

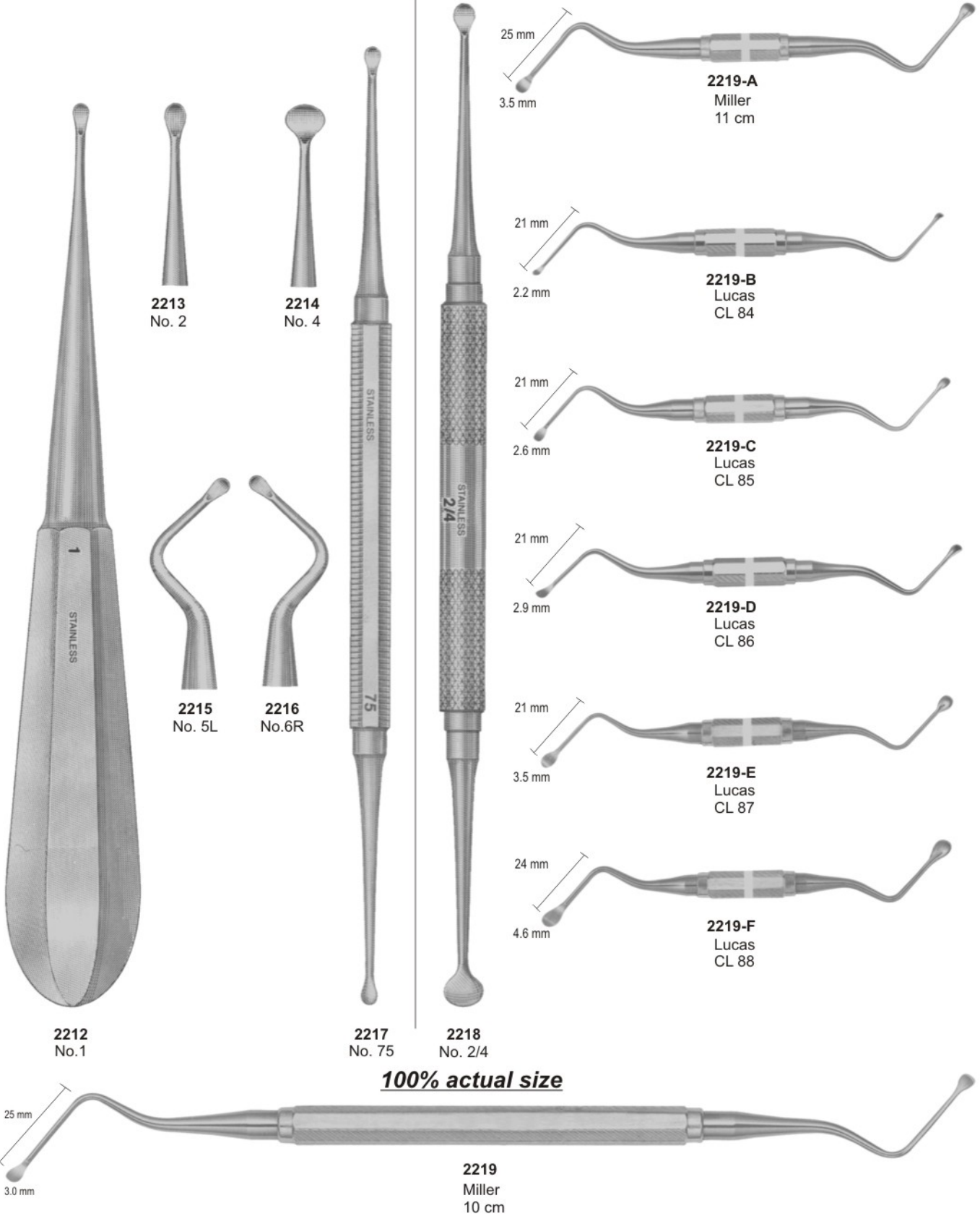

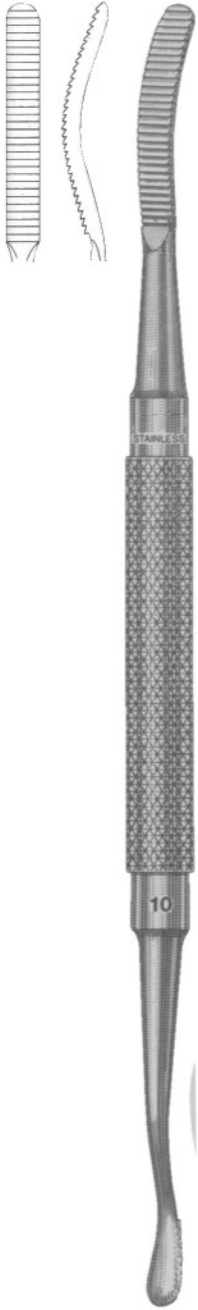

2220
No. 10

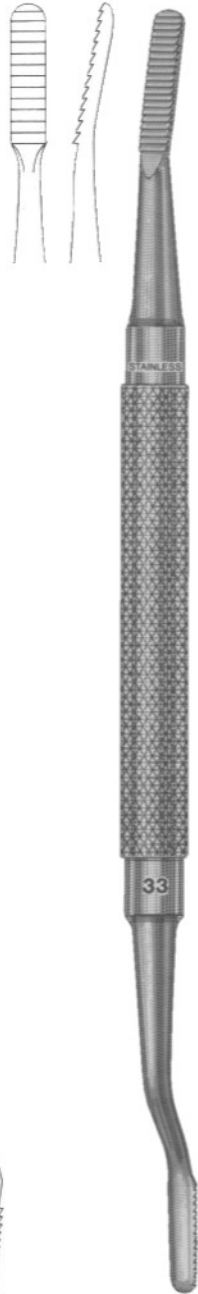

2221
No. 33

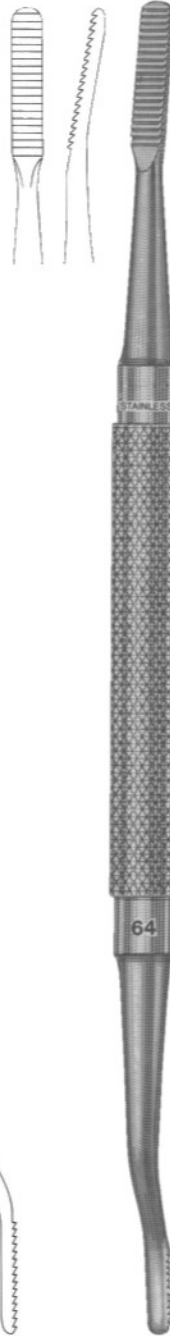

2222
MILLER
No. 33

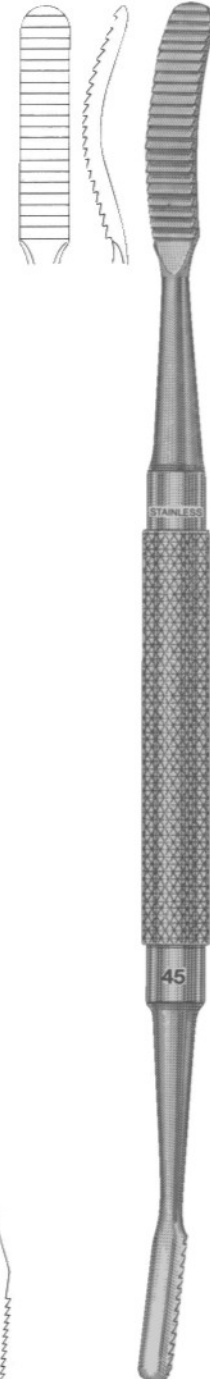

2223
MILLER
No. 64

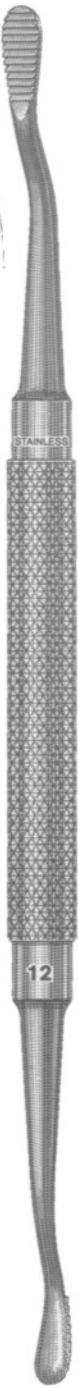
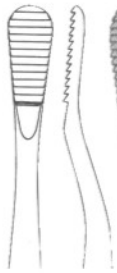

2224
HOWARD
No. 12



2225
HOWARD
No. 12A

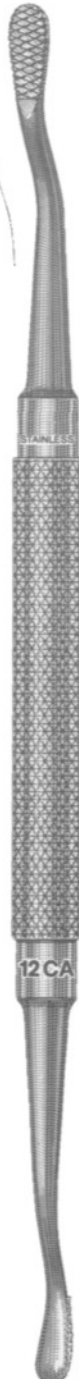

2226
HOWARD
No. 12CA

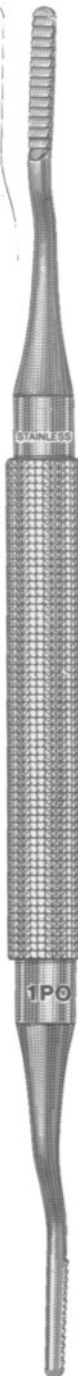
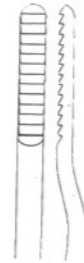

2227
POLOKOFF
No. 1



Bone Chisels

GARDNER

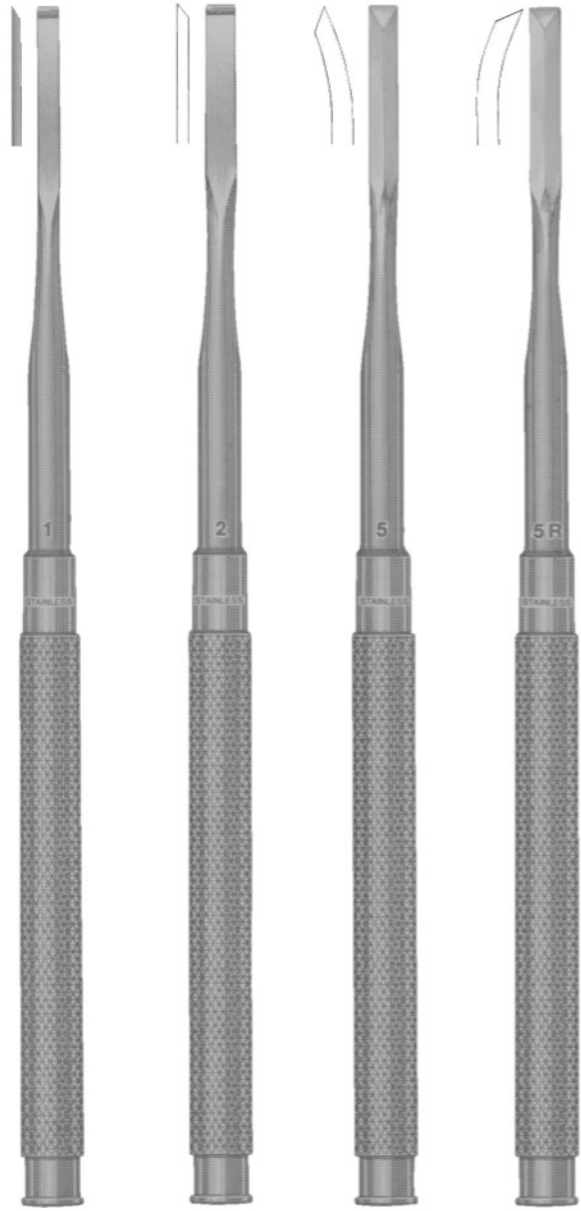

2228
GARDNER
No. 1

2229
GARDNER
No. 2

2230
GARDNER
No. 5

2231
GARDNER
No. 5R

WAKEFIELD

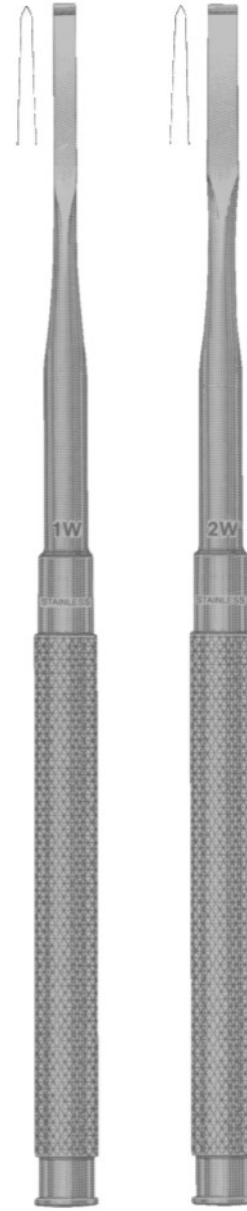

2232
WAKEFIELD
No. 1W

2233
WAKEFIELD
No. 2W

Bone Chisels, Bone Mallets

Bone Chisels and Gouges

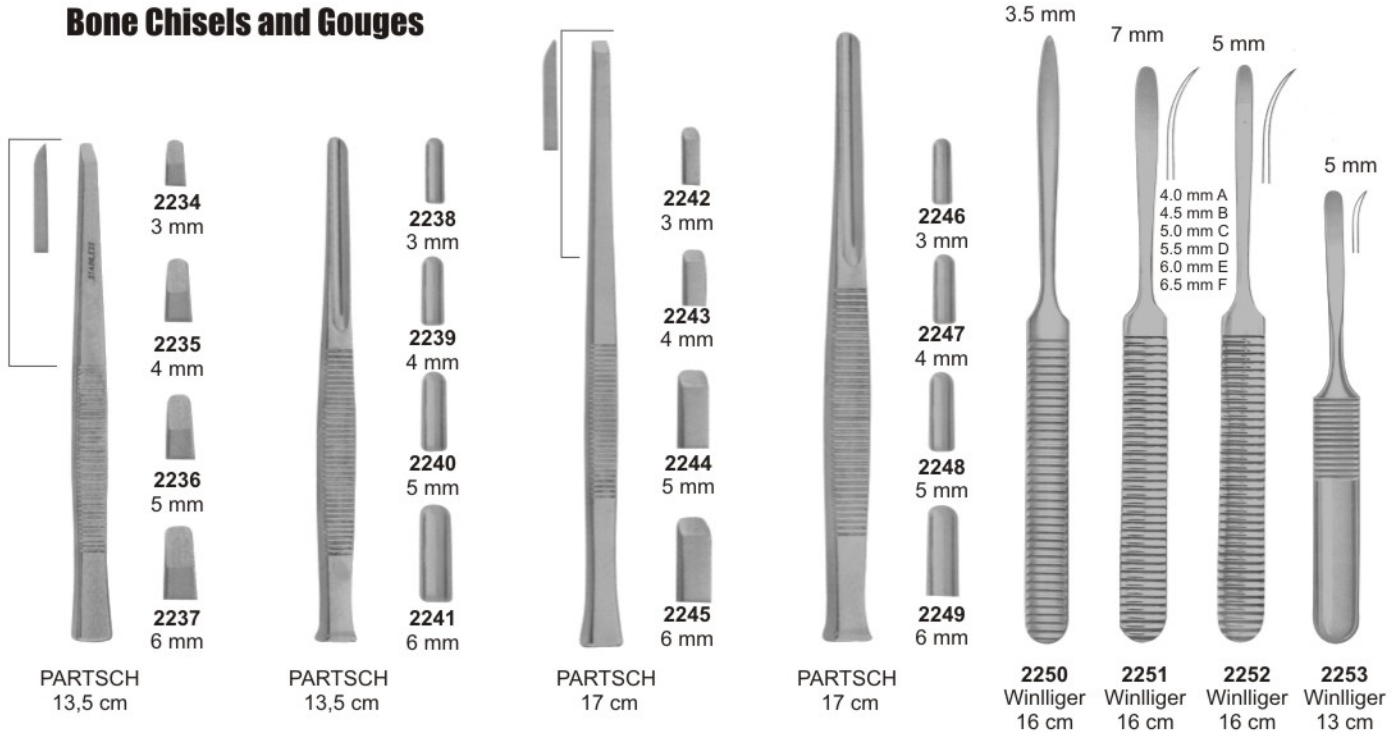

Martelli chirurgici Mallet

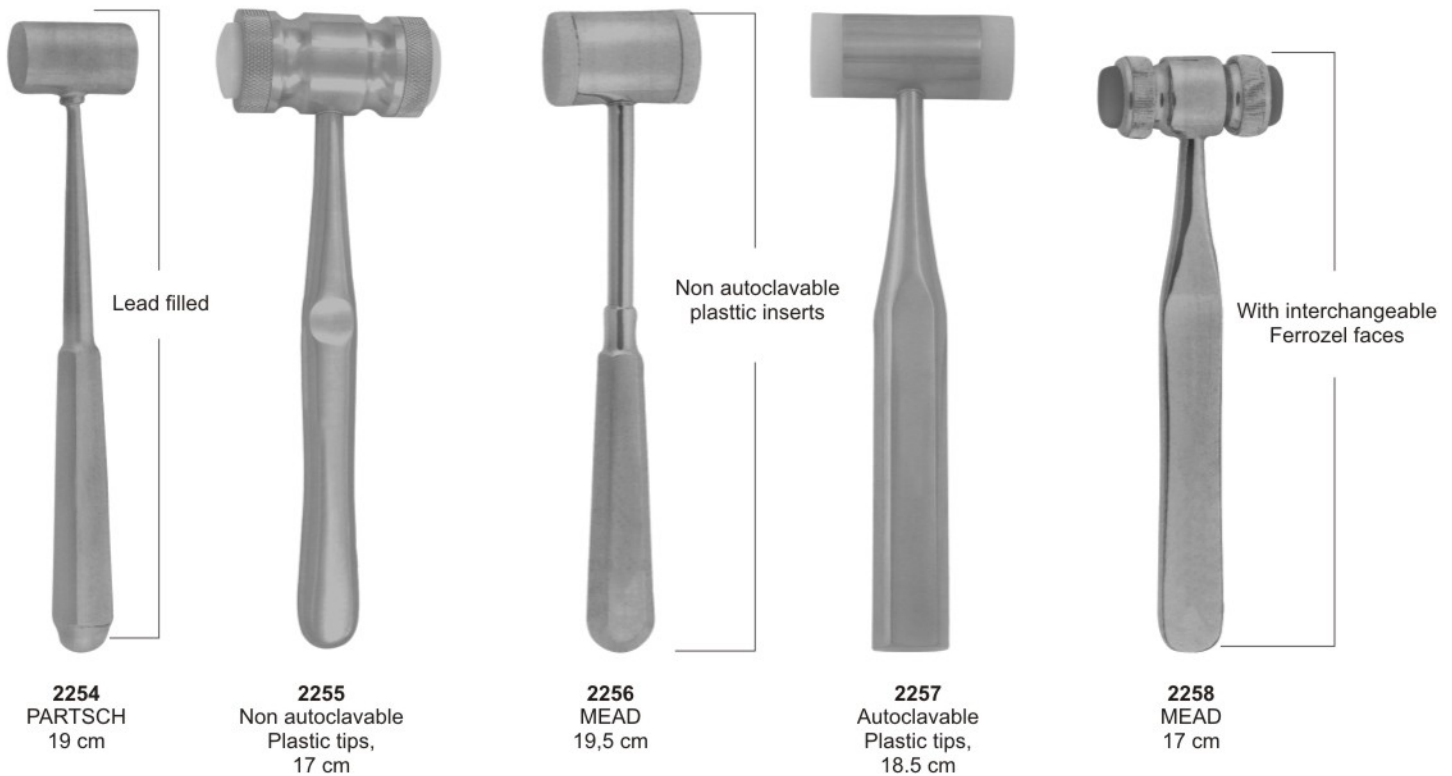

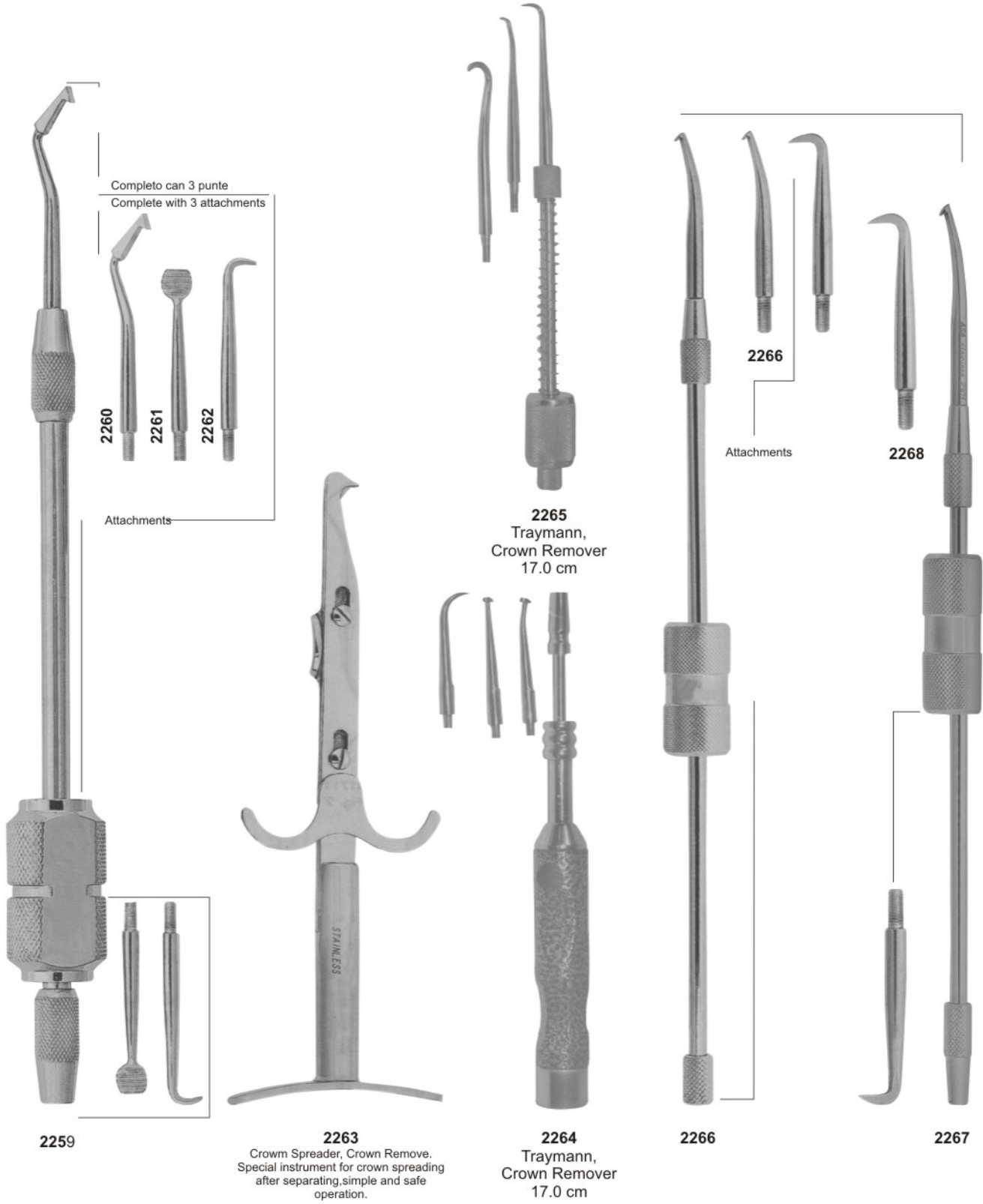

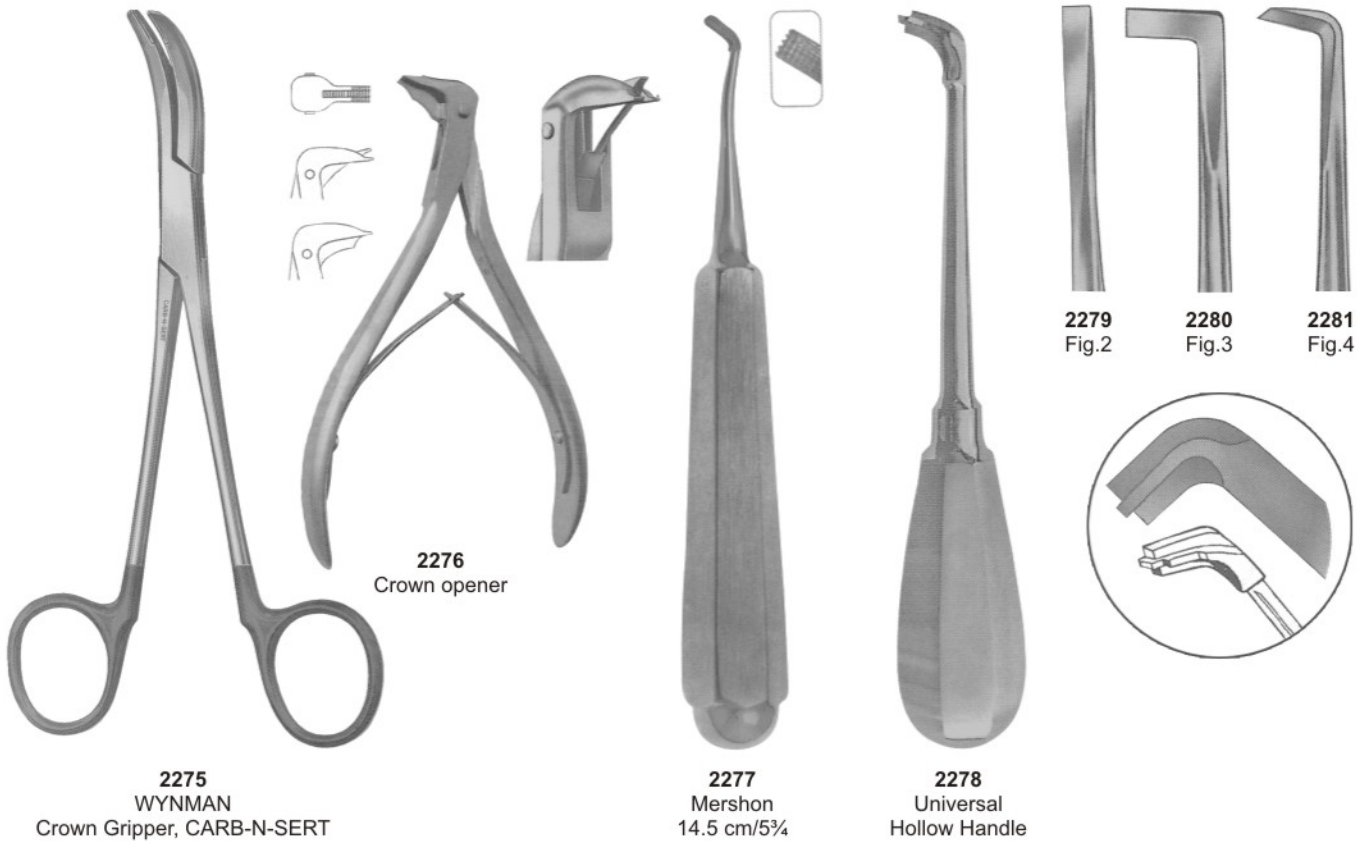
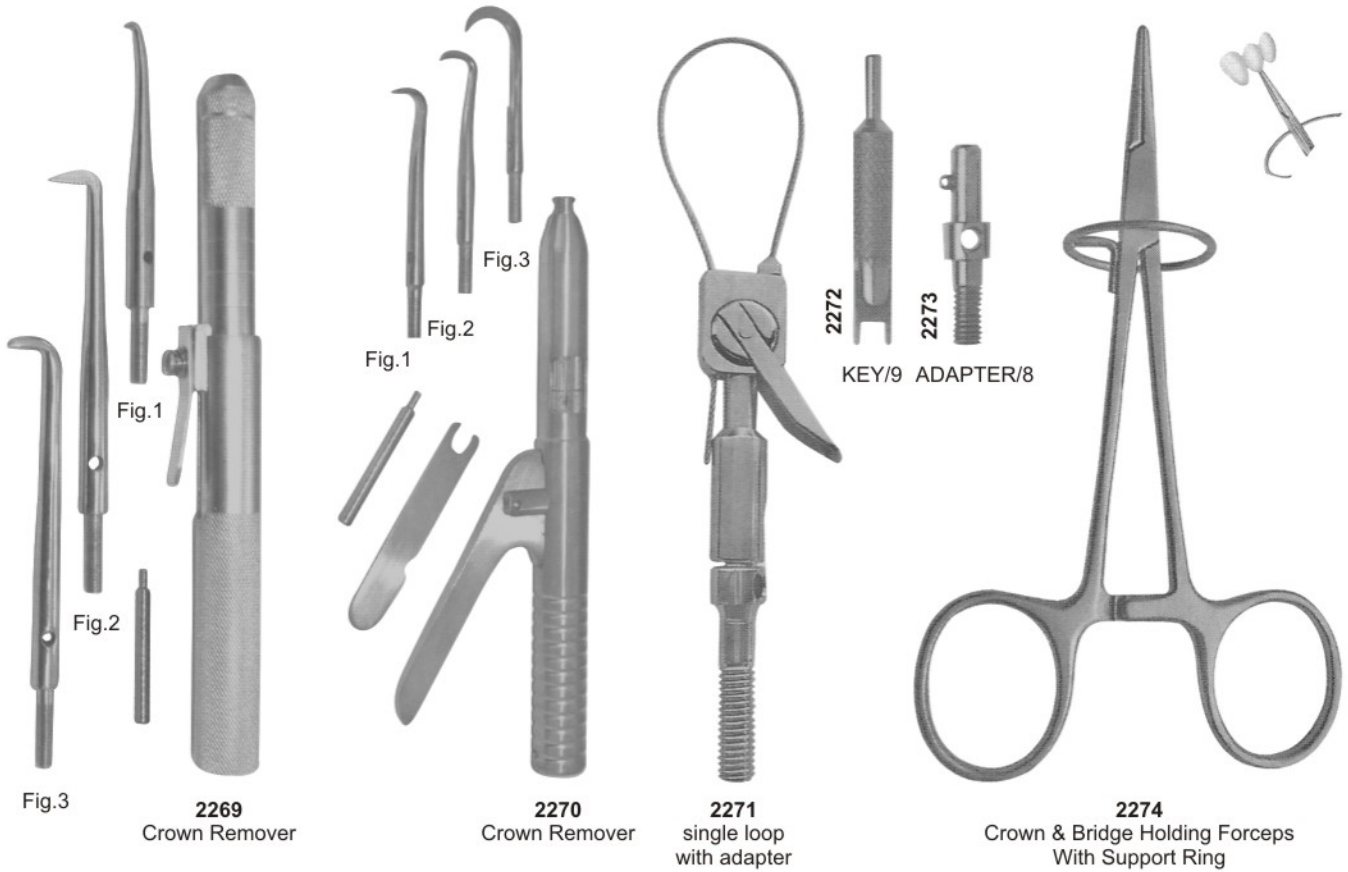



2282
Plaster Shear
210 mm



2283
Crown Removing Plier
14 cm



2284
MONTFORT
18 CM



2285
BOHM
16 cm



2286
Telescope Crown
Plier, Diamond coated
13.0 cm



2287
Telescope Crown
Plier, Diamond coated
13.0 cm



2288
Telescope Crown Plier
13.0 cm geriefen Maul
15.0 cm geriefen Maul
13.0 cm gelatts Maul
15.0 cm gelatts Maul



2289
Telescope Crown
Plier, Fine
15.0 cm

Implants Instruments

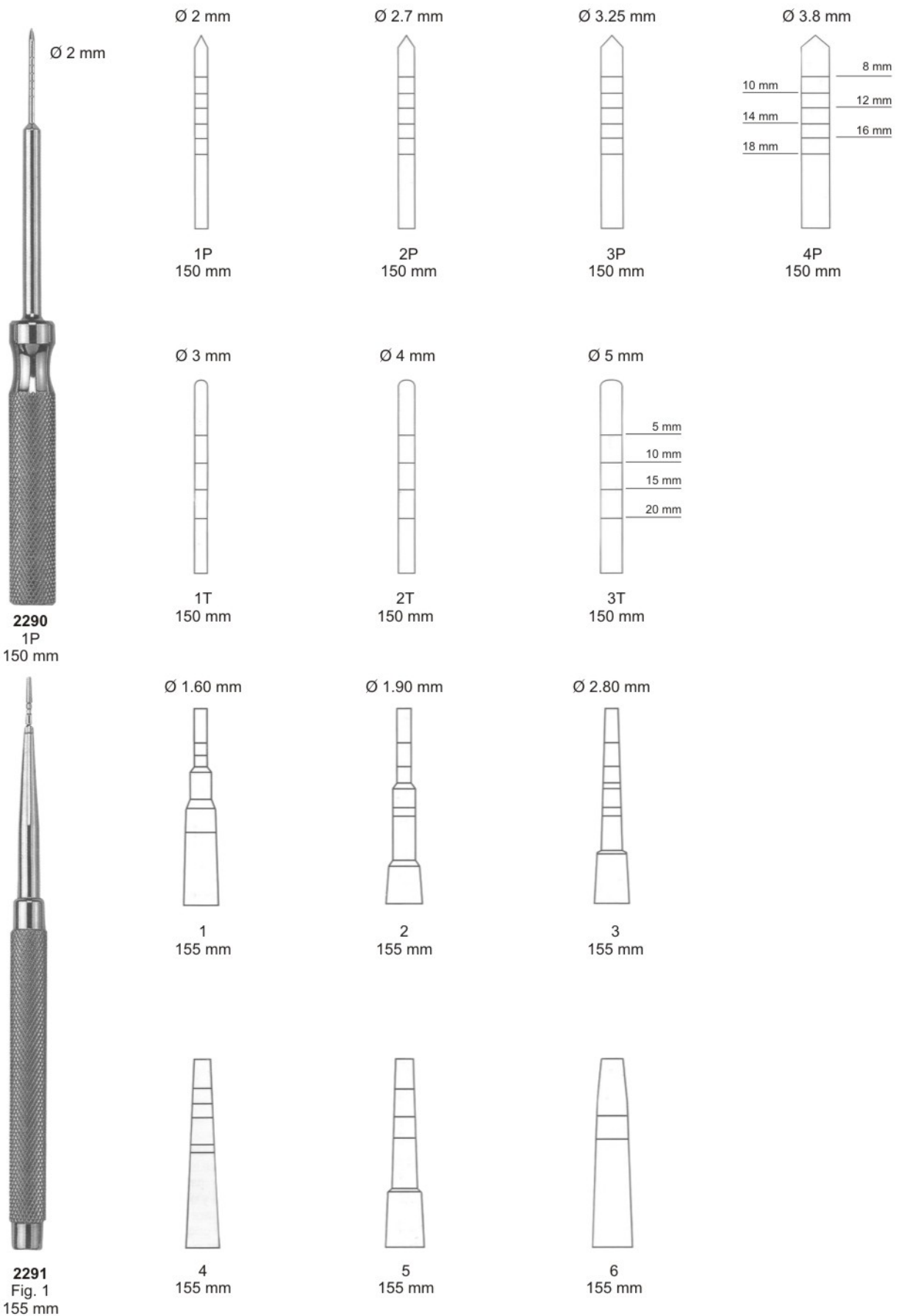

Implants Instruments



2292
Fig. 1B
165 mm

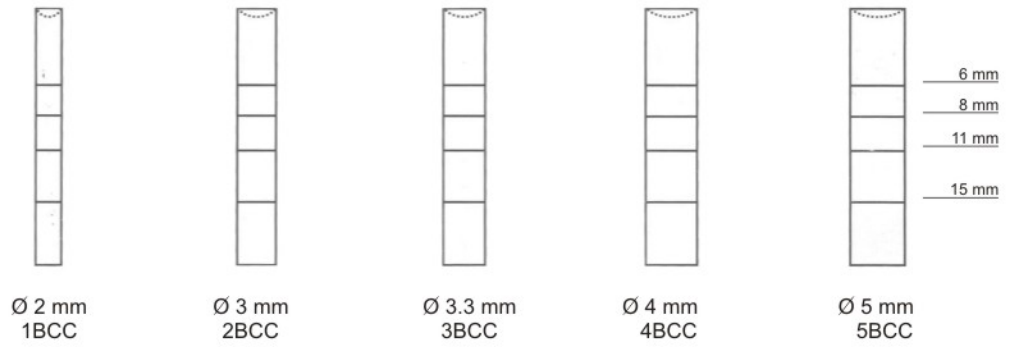
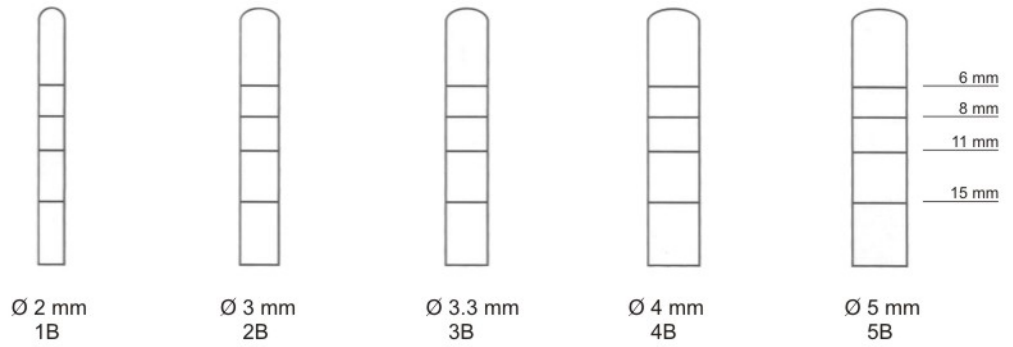

2293
Fig. 1
155 mm

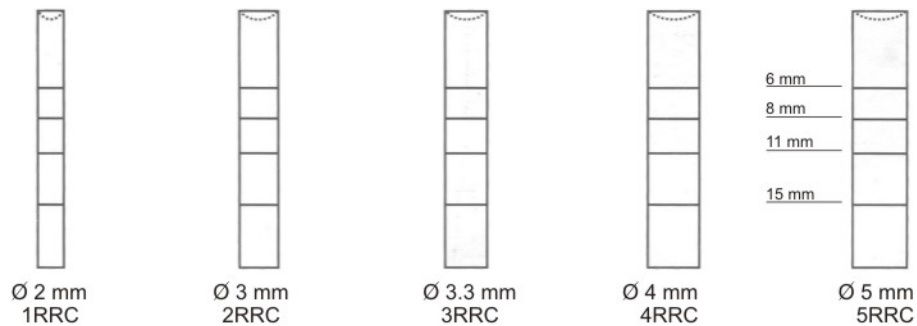
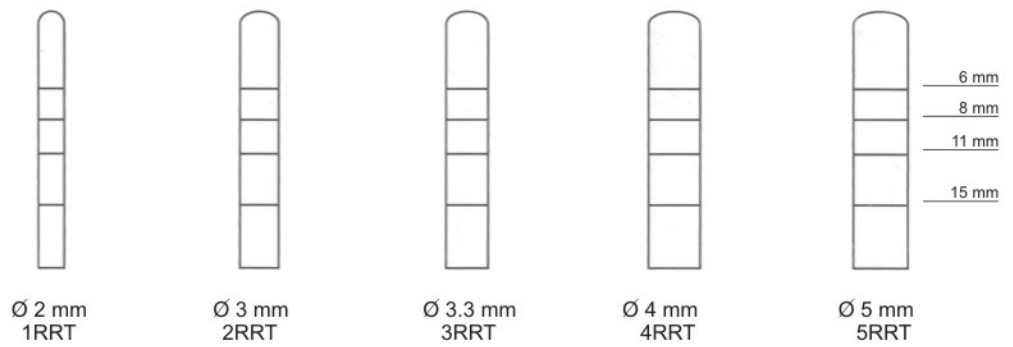

Endo guns for retrograds.

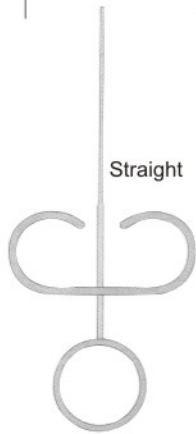

2294
Ø 1.2 mm
130 mm

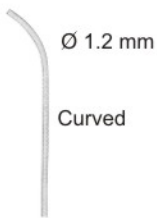

Carry any mixed materials to perforations, apical or difficulty to access sites.



2295
Ø 1.8 mm
130 mm



Bone Injectors



2296
Ø 2.5 mm
150 mm



2297
Ø 4.4 mm
150 mm



2298
Ø 7 mm
150 mm



2299
Ø 2.5 mm
150 mm



2300
Ø 4.4 mm
150 mm



Bone well

2301
Ø 35 mm
h 35 mm



2302
Grinders for autogenous

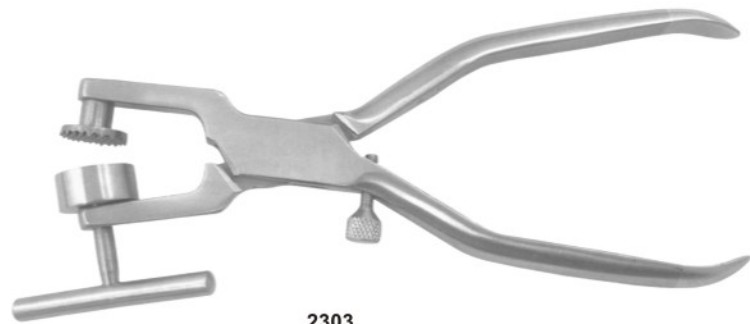

2303
Bone Mill Forcep
17.0 cm

**Suction Tubes, Bone
Pluggers & Rongeurs**

Suction Tubes

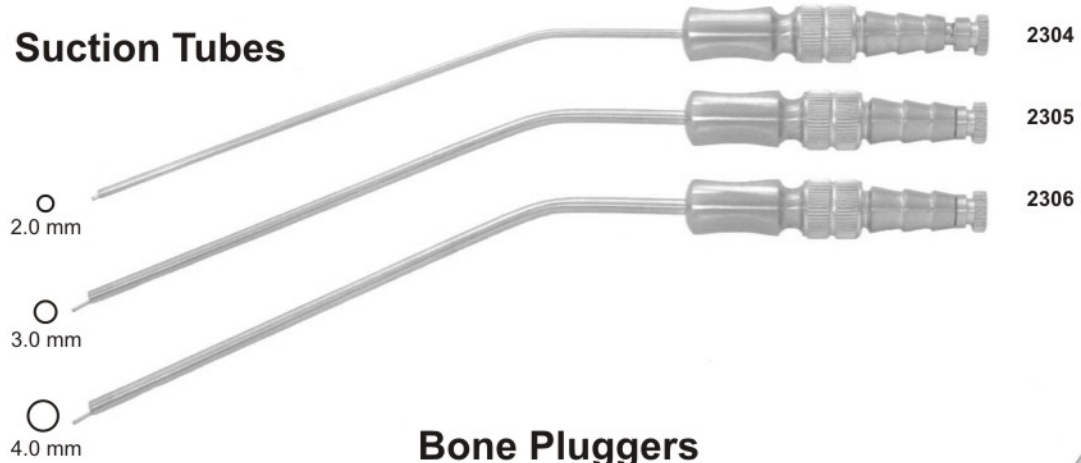

Bone Pluggers



Kerrison Rongeurs



(1.5 mm inside) 2311
 (2.0 mm inside) 2312
 (3.0 mm inside) 2313
 (4.0 mm inside) 2314
 (4.5 mm inside) 2315
16.5 cm

(1.0 mm inside) 2316
 (2.0 mm inside) 2317
 (2.50 mm inside) 2318
16.5 cm



2319
Fig. 1
170 mm

2320
Fig. 2
175 mm

2321
Fig. 3
170 mm

2322
LUCAS
Fig. 88
170 mm

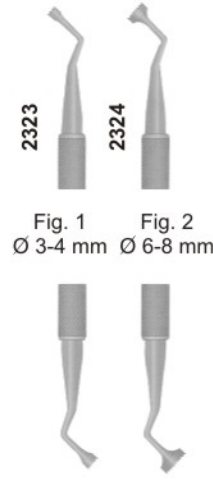

Bone Compactors.

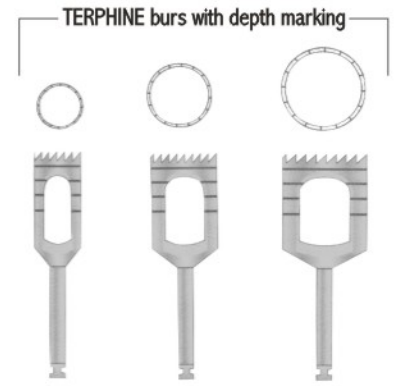

2325 Ext. Ø 3.5 mm Int. Ø 3 mm
2326 Ext. Ø 6 mm Int. Ø 5 mm
2327 Ext. Ø 8.5 mm Int. Ø 7.55 mm
2328 Ext. Ø 11 mm Int. Ø 10 mm

Sinus lift instruments

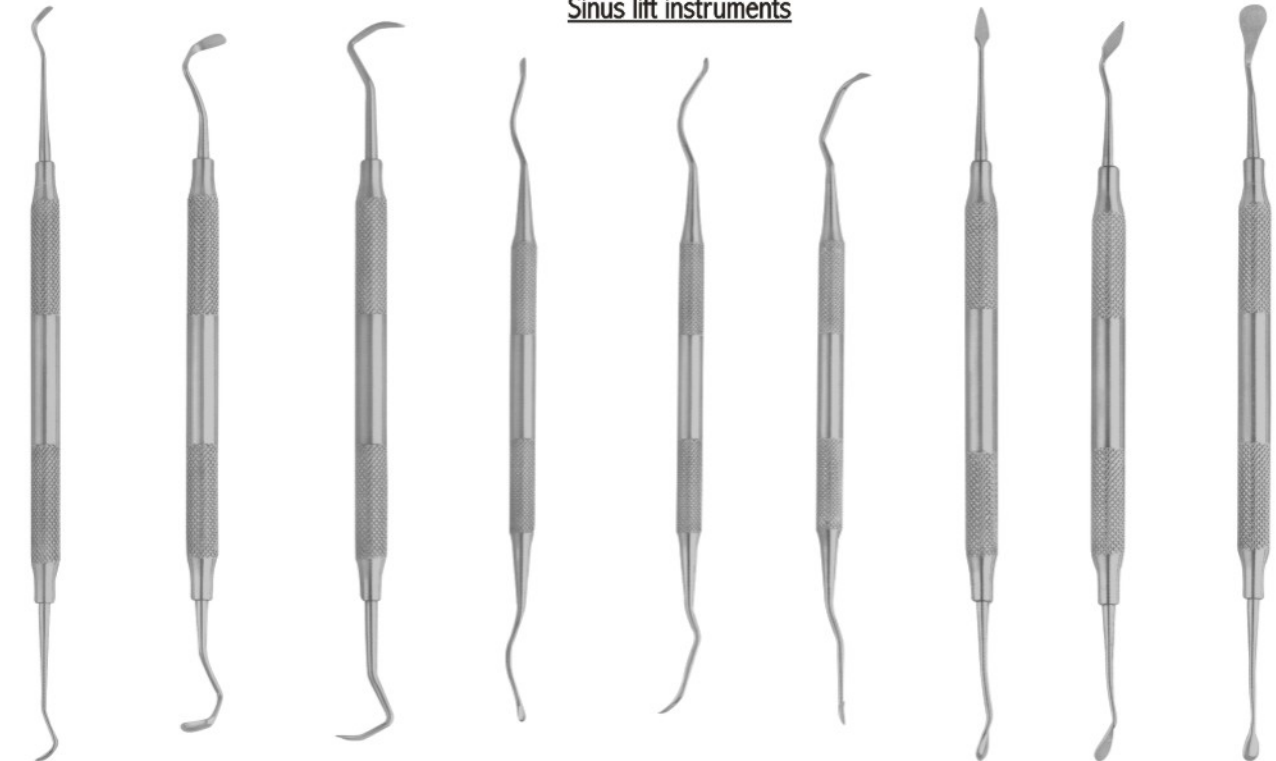

2329
Fig.1

2330
Fig.2

2331
Fig.3

2332
Fig.4

2333
Fig.5

2334
Fig.6

2335
Fig.7

2336
Fig.8

2337
Fig.9



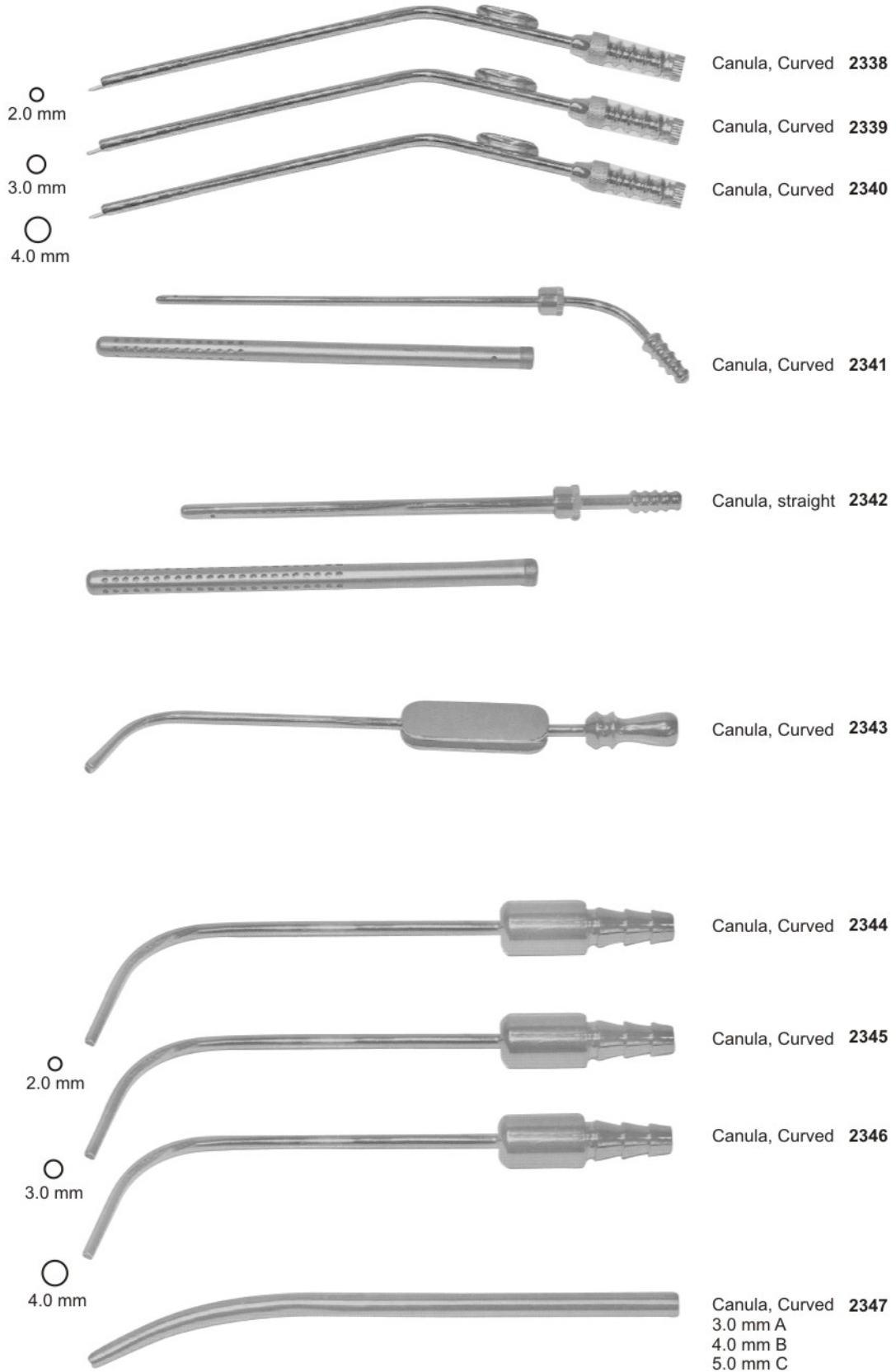

- ⟨☞⟩ Measuring Instruments
- ⟨☞⟩ Amalgam Guns & Carriers
- ⟨☞⟩ Retainers
- ⟨☞⟩ Rubber Dam Instruments
- ⟨☞⟩ Syringes
- ⟨☞⟩ Tweezers
- ⟨☞⟩ Sterilizing & Lab. Instruments



05

SECTION





2348
BOLEY Gauge



2349
ZURICHER
130 mm



2350
VERNIER
12 cm



2351
VERNIER



2352
VERNIER Gauge



2353
VERNIER Gauge



2355
Finger Ruler



2354
LWANSON
Crown Gauge



2356
LWANSON
Crown Gauge



2357
Sliding Gauge
10 cm



2358
Spring Bow Divider
6" Radius

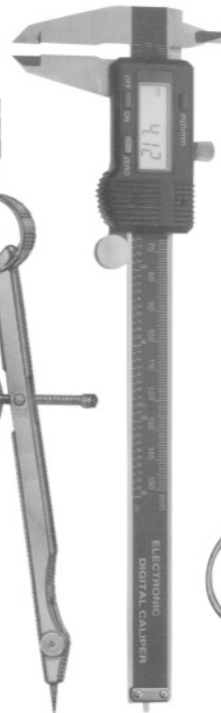

2359
VERNIER
Gauge



2360
ALBEE



2361
Height Gauge
Wick Type

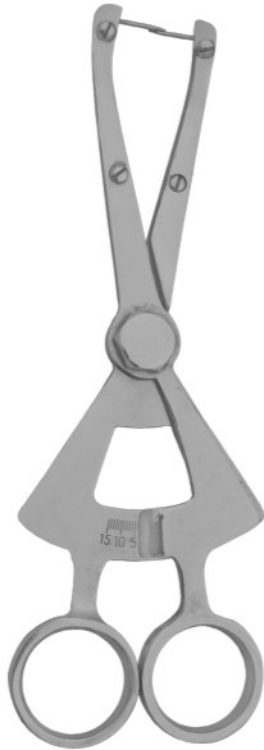

2362
Bone Gauge



2363
Bone Caliper
15 cm



2364
Castroviejo



2365 A
Castroviejo
Curved



2365 B
Straight



2366 C
Castroviejo
Straight

2366 D
Curved



2367
Gauge

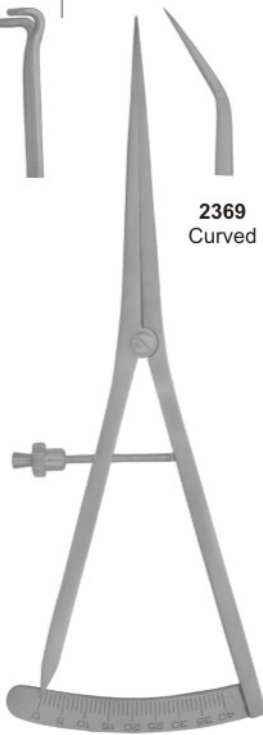

2368
Castroviejo
Straight

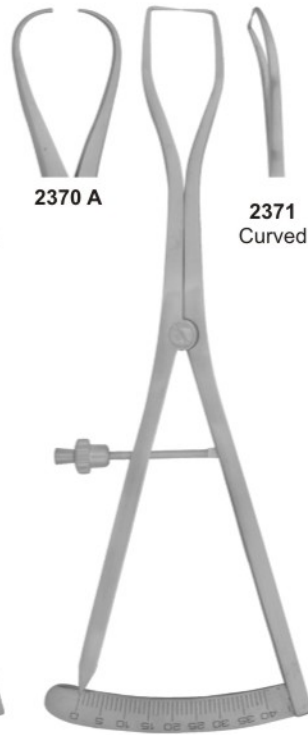

2370
Castroviejo
Straight



2373
Boone - Gauge

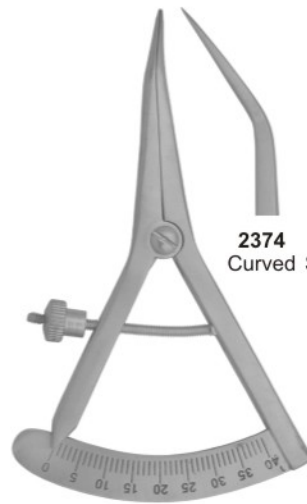

2372
Castroviejo



2374
Curved



2375
Straight



2376
Bracket Gauge. Ant/Post



Amalgam Guns & Carriers

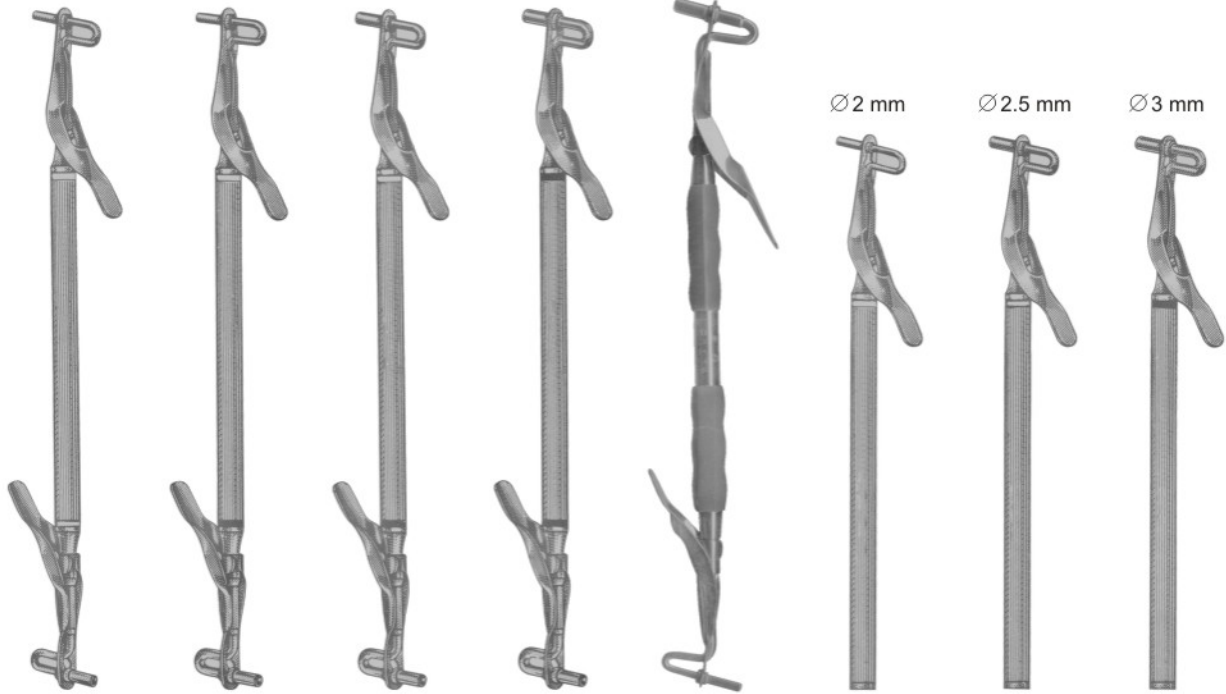

| | | | | | | | |
|--------------------------------------|--------------------------------------|-------------------------------------|-------------------------------------|---|----------------------------------|---------------------------------|---------------------------------|
| 2377 Medium-Large 20 cm | 2378 Medium-Jumbo 20 cm | 2379 Large-Jumbo 20 cm | 2380 Jumbo-Jumbo 20 cm | 2381 Regular-Jumbo Silicon Grip 20 cm | 2382 Medium 15.5 cm | 2383 Large 15.5 cm | 2384 Jumbo 15.5 cm |
|--------------------------------------|--------------------------------------|-------------------------------------|-------------------------------------|---|----------------------------------|---------------------------------|---------------------------------|

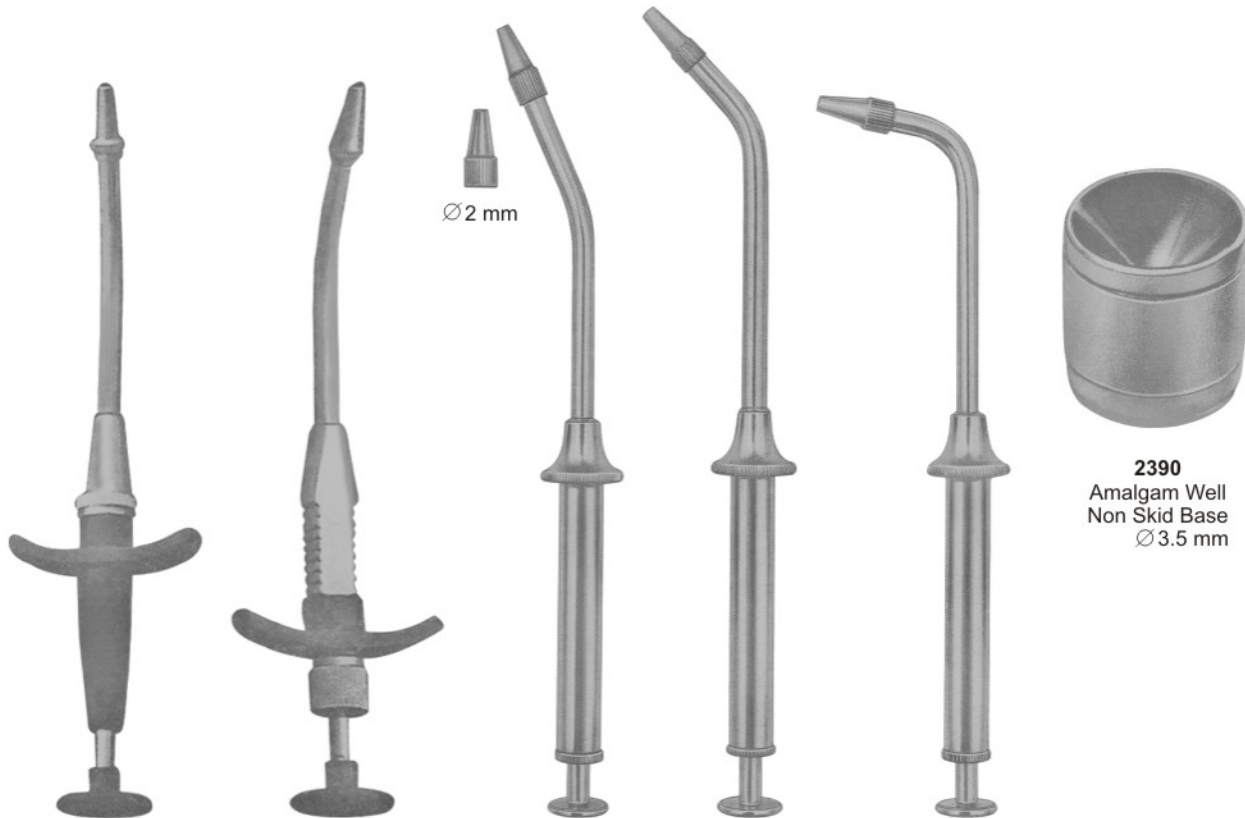

| | | | | | |
|-----------------------|-----------------------|--|--|-----------------------------|--|
| 2385 145 mm | 2386 130 mm | \varnothing 2 mm 2387 Straight 15 cm | \varnothing 2 mm 2388 15 cm | 2389 15 cm 90° | 2390 Amalgam Well Non Skid Base \varnothing 3.5 mm |
|-----------------------|-----------------------|--|--|-----------------------------|--|

**Retainers, Bands, Strip
Holder Clips, Napkin Holders**

Retainers



2391
No. 1

2392
No. 8

2393
No. 9

"Tofflemire" Type Retainers

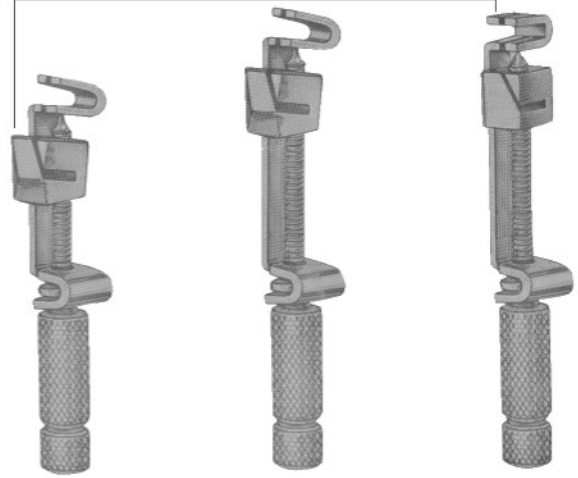

2394
JUNIOR-CA

2395
SENIOR-CA

2396
UNIVERSAL

Tofflemire Bands

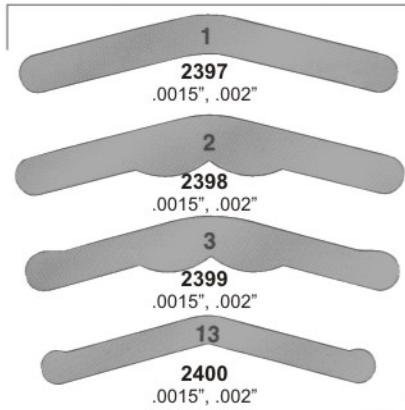

1
2397
.0015", .002"

2
2398
.0015", .002"

3
2399
.0015", .002"

13
2400
.0015", .002"

2401
X-Ray Holder
Small



Set of 10
2402
Film Hanger

Napkin Holders

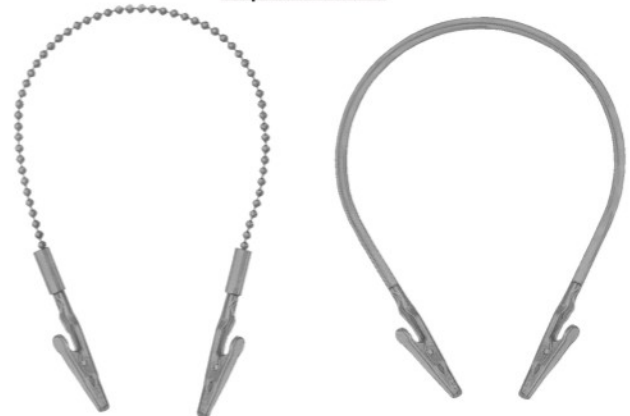

2403
BALL CHAIN

2404
NON-CHILL
Clear Plastic

Strip Holders

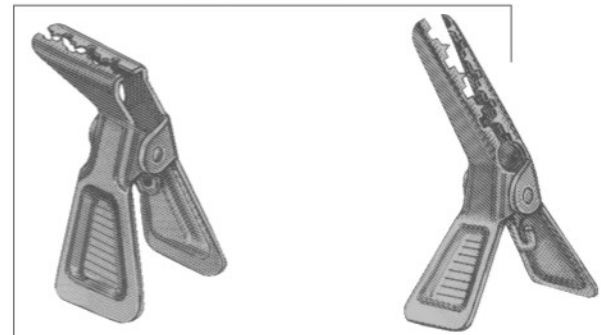

2408
Strip Holder Clip
90°

2409
Strip Holder Clip
45°

2405
Finger Protector
Small

2406
Medium

2407
Large

Rubber Dam Instruments



2410
IRORY
Light weight, 170 mm



2411
BREWER
175 mm

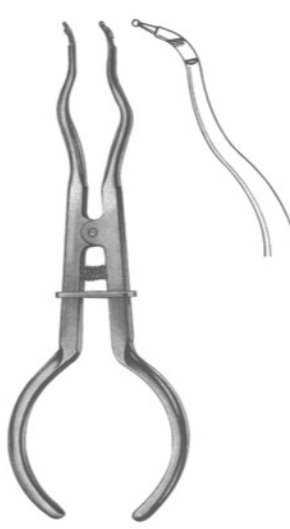

2412
BREWER
175 mm



2413
WHITE
175 mm



2414
IVORY
170 mm



2415
AINSWORTH
Rubber Dam Punch
170 mm



2416
AINSWORTH
Rubber Dam Punch
170 mm



2417
AINSWORTH
Rubber Dam Punch
170 mm

Articulating Paper Forceps



2421
MILLER
Articulating
Forceps
15 cm

2422
MILLER
Articulating
Forceps
15 cm

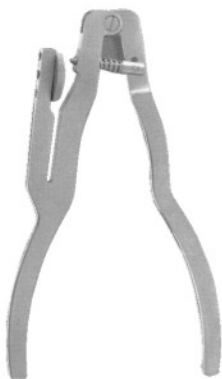

2418
"IV" Type
Rubber Dam Punch
160 mm



2419
Plastic Rubber Dam
Frame 242

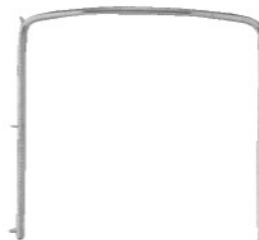

2420
Rubber Dam Holder
Stainless Steel Pins

Rubber Dam Clamps

LOWER MOLARS

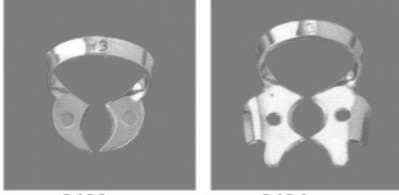

2423
76D-W3

2424
76D-3

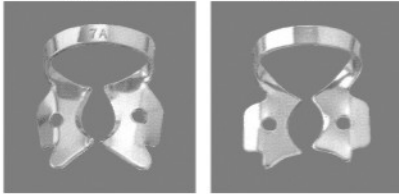

2429
76D-7A

2430
76D-7

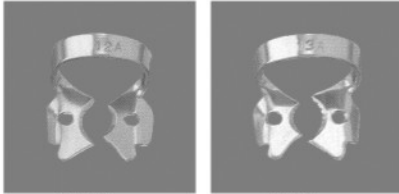

2435
76D-12A

2436
76D-13A

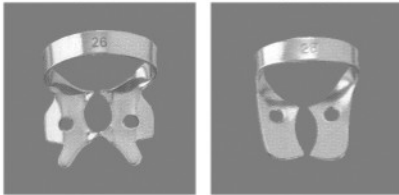

2441
76D-26

2442
76D-28



2445
76D-W8A

2446
76D-8A

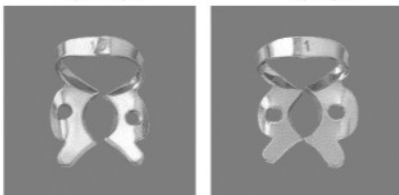

2447
76D-10

2448
76D-11

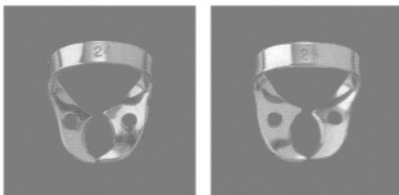

2451
76D-24

2452
76D-25

UPPER MOLARS

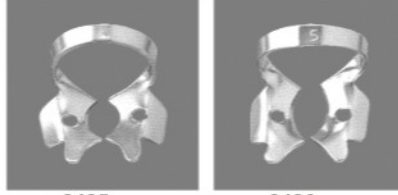

2425
76D-4

2426
76D-5

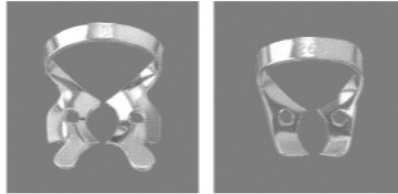

2431
76D-8

2432
76D-26N

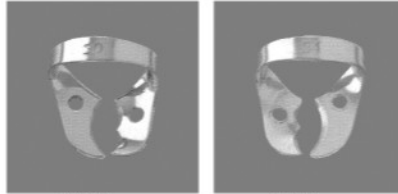

2437
76D-30

2438
76D-31

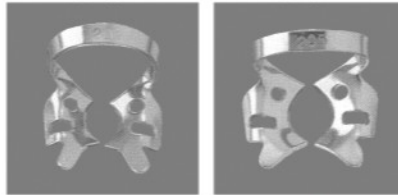

2443
76D-201

2444
205

MOLARS

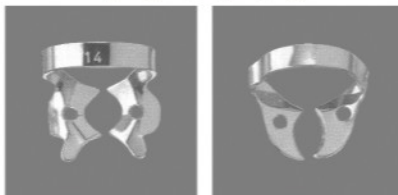

2449
76D-14

2450
76D-118

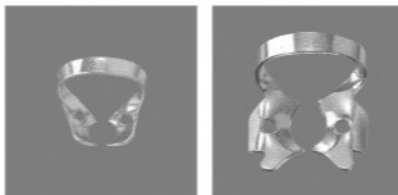

2453
76D-27

2454
76D-56



2455
76D-14A

PREMOLARS

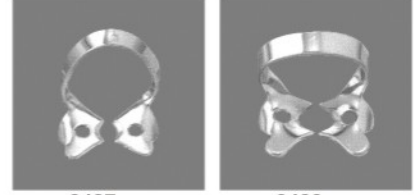

2427
76D-0

2428
76D-1

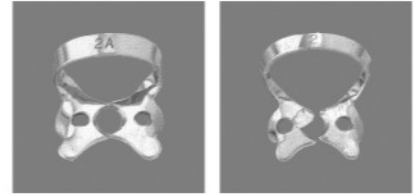

2433
76D-2A

2434
76D-2

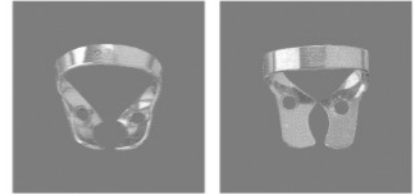

2439
76D-27N

2440
76D-29

ANTERIOR

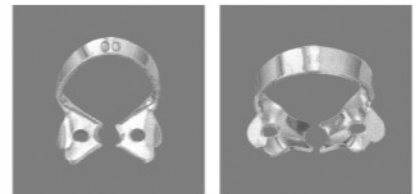

2456
76D-00

2457
76D-1A

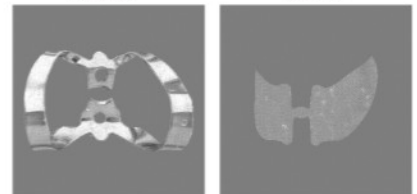

2458
76D-9

2459
76D-212

Aspirating Syringes

4969/CO



4969/F



4969/CV

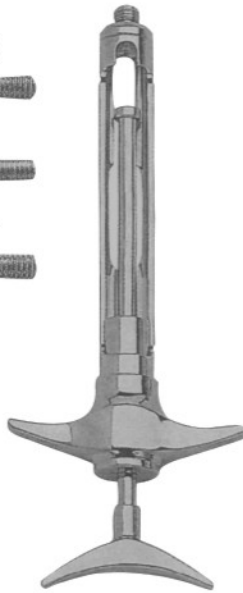

2460
ml 1,8
EU

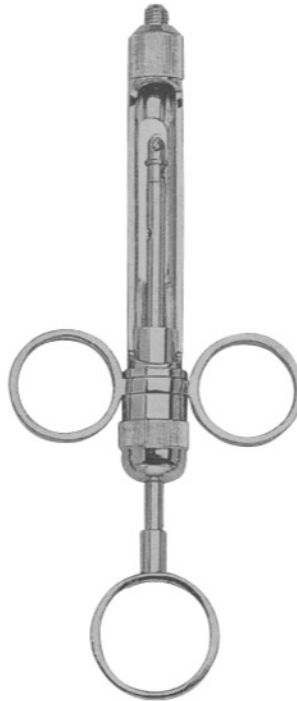

2461
ml 1,8
EU/AM



2462
ml 1,8
EU/AM



2463
Fig. 1
ml 1,8
EU



2464
Fig. 1
ml 1,8
EU



2465
SS INOX
All inox & autoclavable
black plastic handle
passive automatic
aspiration.

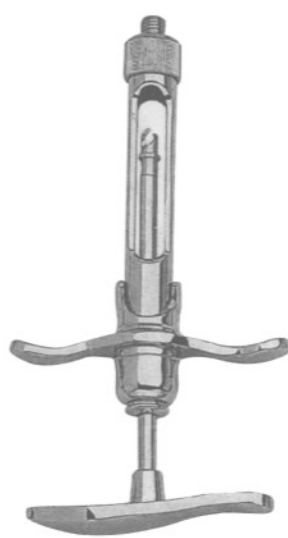

2466
Fig. 1
ml 1,8
EU/Am



2467
Fig. 1
ml 1,8
EU/Am



2468
Fig. 1
ml 1,8
EU/Am

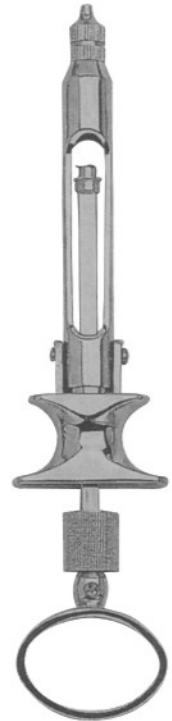

2469
ml 1,2
EU/Am

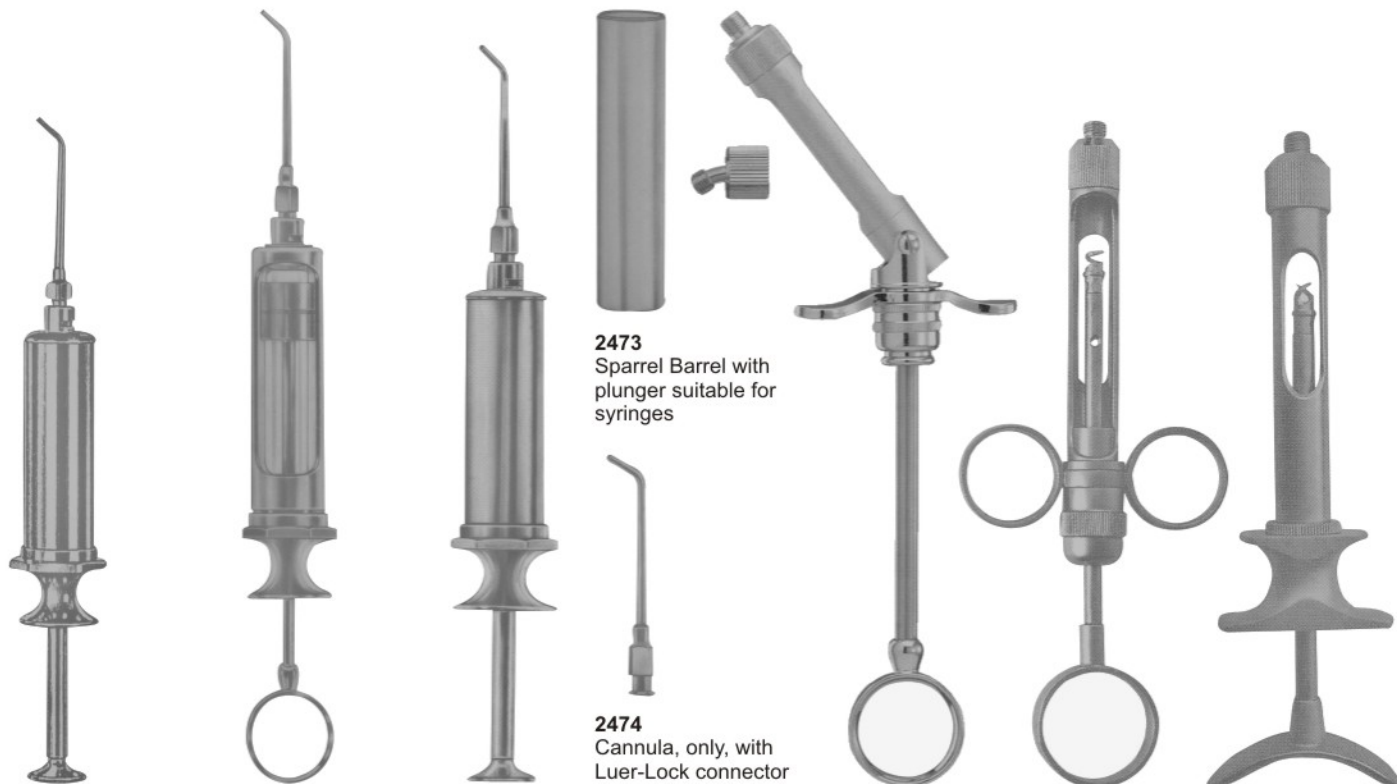

2470
Water Syringe
complete with
1 cannula (Lure-Lock)

2471
Water Syringe
complete with
1 cannula (Lure-Lock)

2472
Metal Water Syringe
self-filling, with 1
cannula (Lure-Lock)

2473
Spare Barrel with
plunger suitable for
syringes

2474
Cannula, only, with
Luer-Lock connector
suitable for syringes

2475
Articulating
Barrel Syringe

2476
ml 1,8

2477
ml 1,8



2478

2479

2480

2481
Fig. 1
ml 1,8 EU

2485
Fig. 1
ml 1,8 EU

2482
Water
point

2483
Water
point

2484
Water
point

Dental Tweezers

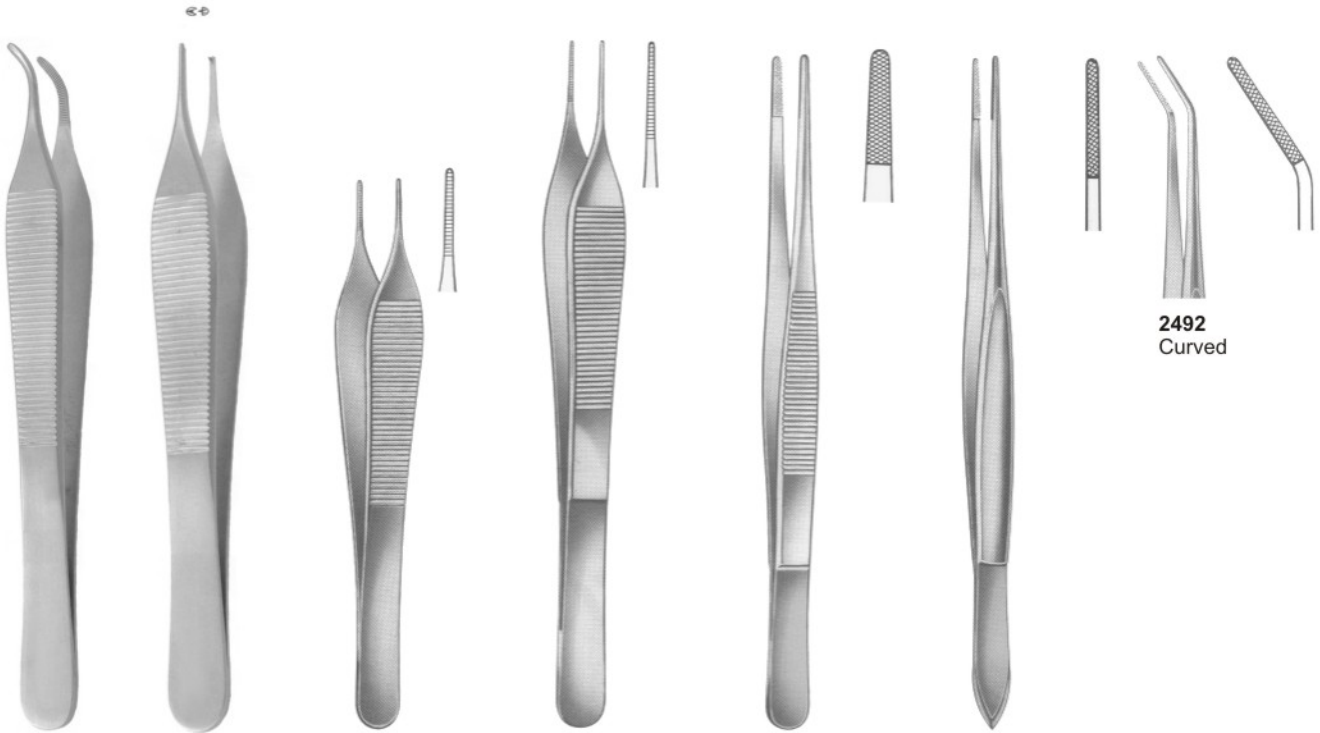

2486
ADSON
Curved 14 cm

2487
ADSON
1X2 / 12 cm

2488
ADSON
12 cm

2489
MICRO ADSON
15 cm

2490
STANDARD
14,18,25 cm

2491
CUSHING
18 cm

2492
Curved

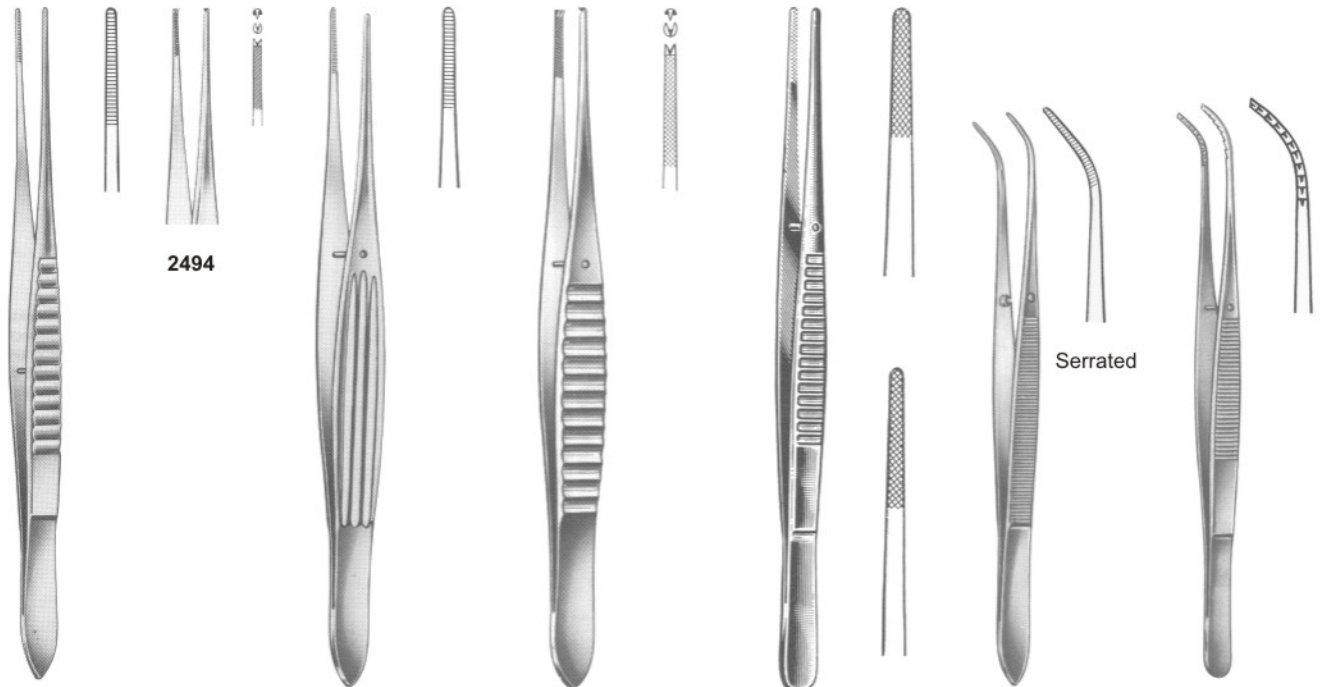

2493
SELECT
15,18,20 cm

2494

2495
MCINDOE
15 cm

2496
GILLIES
15 cm

2497
WAUGH
15,20 cm

2498
PERRY
13 cm

Serrated

2499
KOPP
15.5 cm

Dental Tweezers



smooth

2500
COLLEGE
15 cm



serrated

2501
COLLEGE
15 cm



smooth

2502
COLLEGE
15 cm



serrated

2503
COLLEGE
15 cm



smooth

2504
COLLEGE
15 cm



serrated

2505
COLLEGE
15 cm



smooth

2506
COLLEGE
15 cm



serrated

2507
COLLEGE
15 cm

Dental Tweezers



2508
MERIAM
16 cm



smooth



2509
MERIAM
16 cm



serrated



2510
MERIAM
16 cm



smooth



2511
MERIAM
16 cm1



serrated



2512
MERIAM
16 cm



smooth



2513
MERIAM
16 cm



serrated



2514
MERIAM
16 cm



smooth



2515
MERIAM
16 cm



serrated

Dental Tweezers

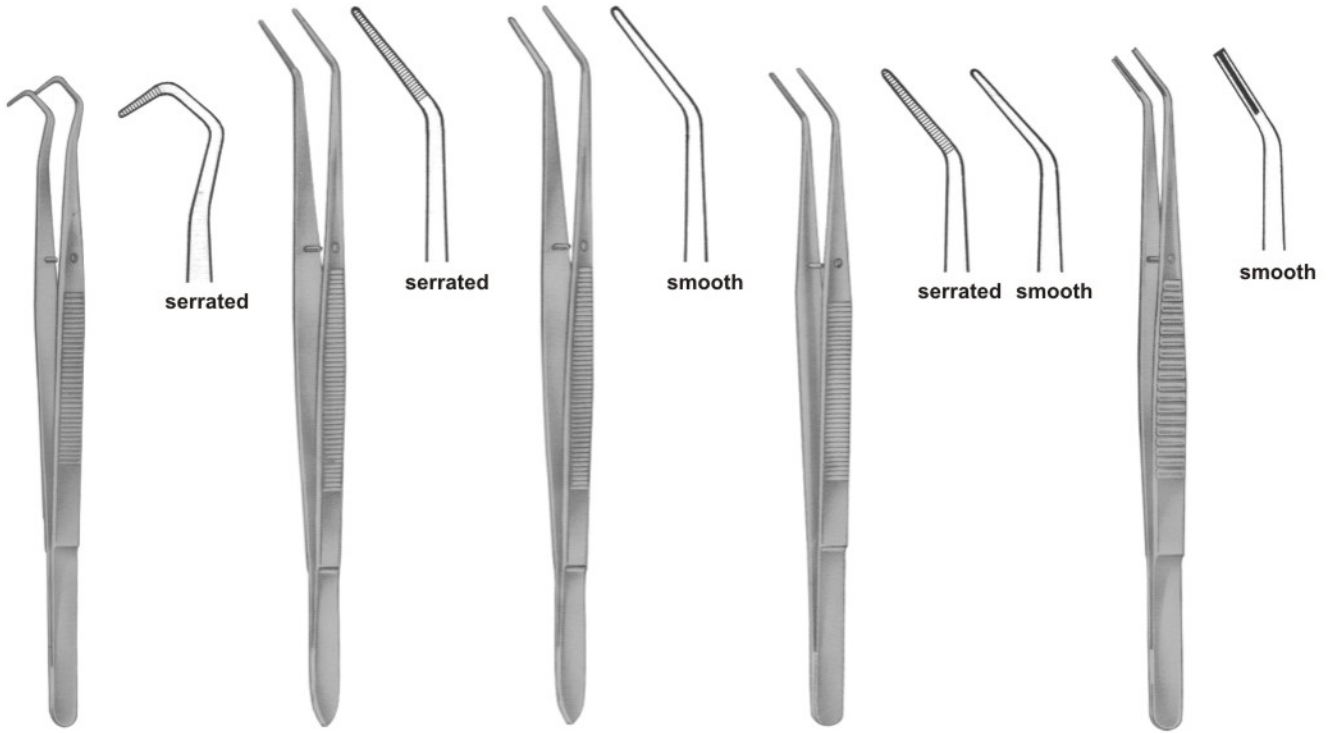

2516
COLLEGE
14.5 cm, 5³/₄"

2517
FLAGG
16 cm, 6¹/₄"

2518
FLAGG
16 cm, 6¹/₄"

2519
LANDGRAF
15 cm, 6"

2520
15,5 cm, 6¹/₈"

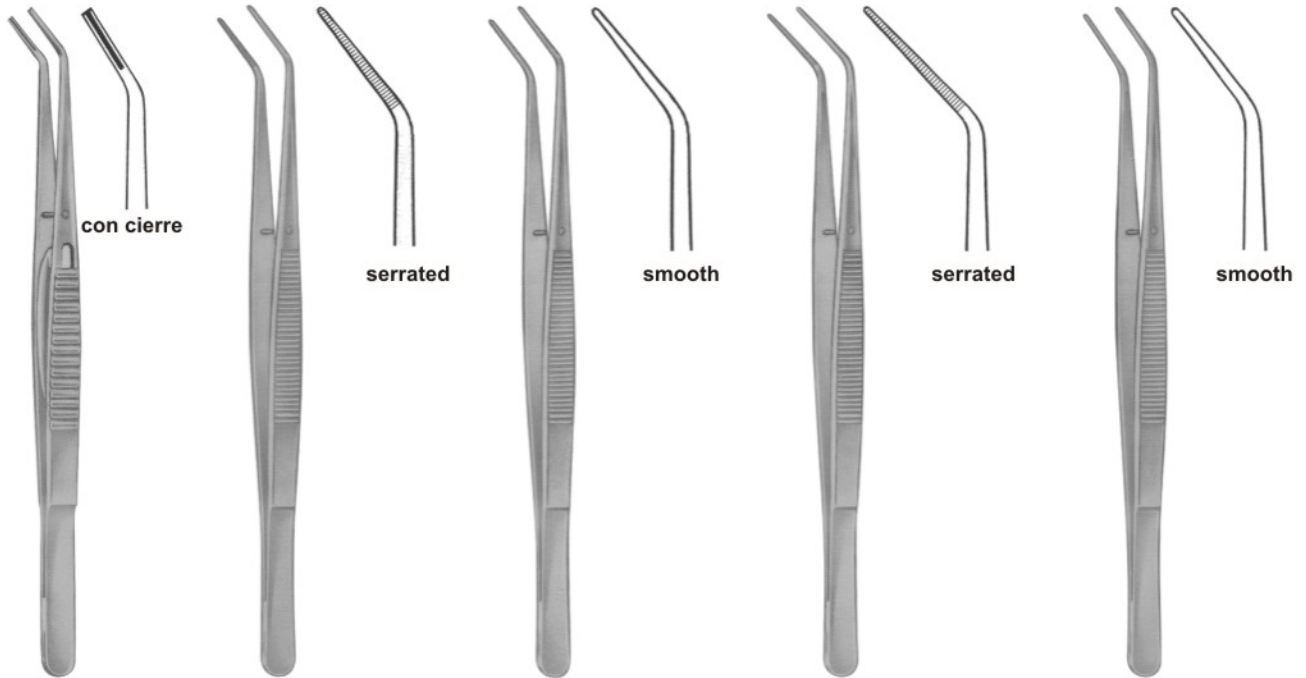

2521
15.5 cm, 6¹/₈"

2522
LONDON-COLLEGE
15 cm, 6"

2523
LONDON-COLLEGE
15 cm, 6"

2524
LONDON-COLLEGE
15 cm, 6"

2525
LONDON-COLLEGE
15 cm, 6"

Dental Tweezers



2526
LONDON-COLLEGE
15 cm, 6"



2527
LONDON-COLLEGE
15 cm, 6"



con cierre



2528
MERIAM
16 cm, 6 1/4"



serrated



smooth

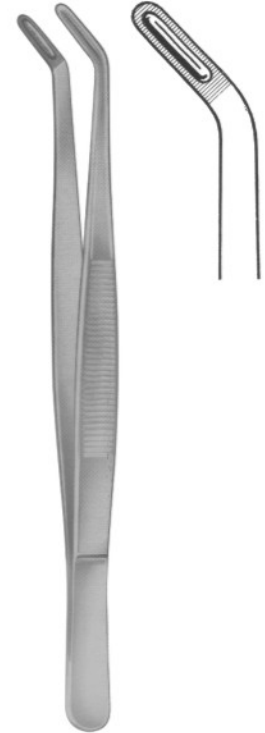

2529
ALLEN
18 cm, 7 1/8"



2530
ALBRECHT
16 cm, 6 1/4"

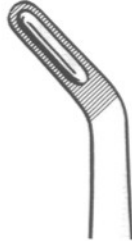

2531
ALBRECHT
16 cm, 6 1/4"



2532
16 cm, 6 1/4"



2533
16 cm, 6 1/4"



2534
16 cm, 6 1/4"





2535
DAVIS
6"

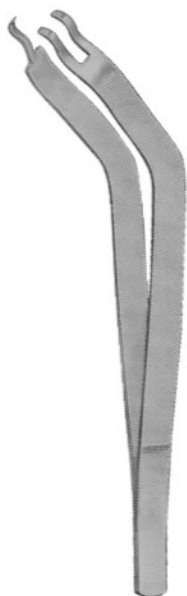

2536
Grasping Forceps
6 1/4"



2537
Mesh Bur & Diamond Holder
Large, 2 1/8" Diameter



2538
Soldering Tweezers
6 1/4"



2539
Narrow Fine
4 3/4"



2540
Super Fine
4 3/8"



2541
Fine Curved
4 1/2"



2542
Bonding Bracket
Holder
136 mm



2543
Bonding Bracket
Holder
135 mm







2544
Bonding Bracket
Holder
135 mm

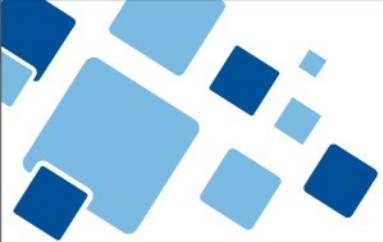

2545
Bonding Bracket
Holder
140 mm



-  Endodontic Forceps
-  Tissue Forceps
-  Retractors
-  Mouth Gags

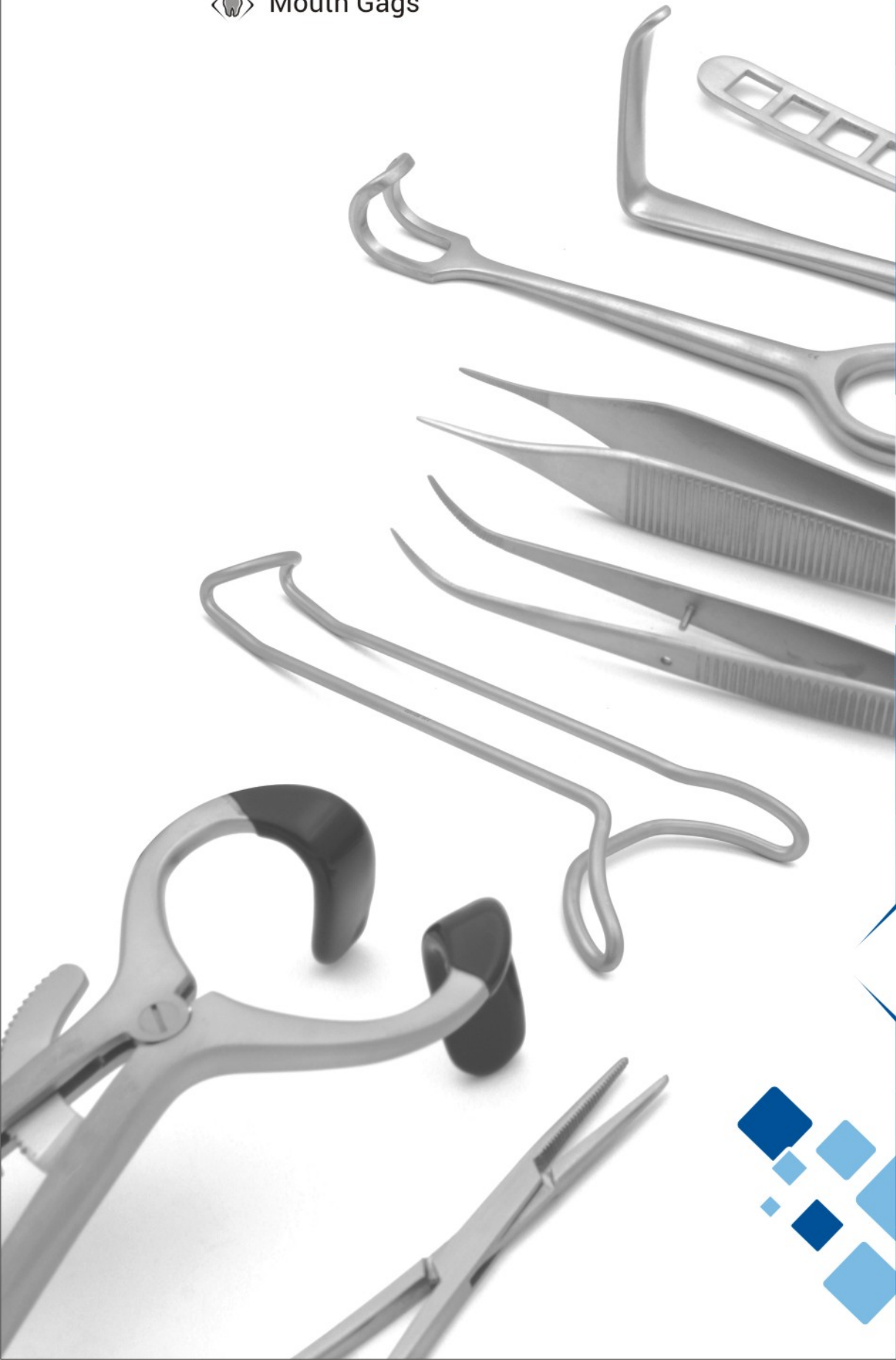

06
SECTION



Endodontic Forceps



2546
Endo Forceps
4 3/4"



2547
PEETS Forceps
4 3/4", Useful For
Removing Broken
Instruments

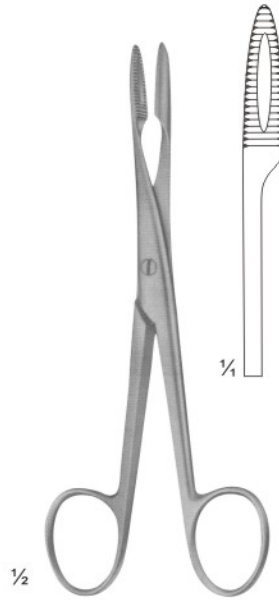

2548
Without Ratchet
145 mm

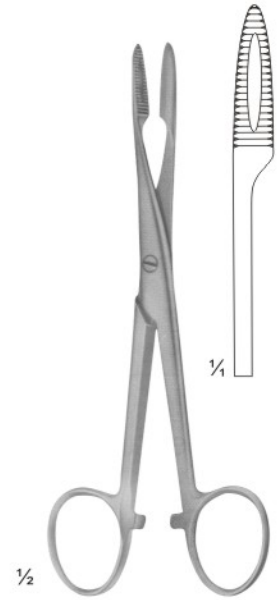

2549
With Ratchet
145 mm

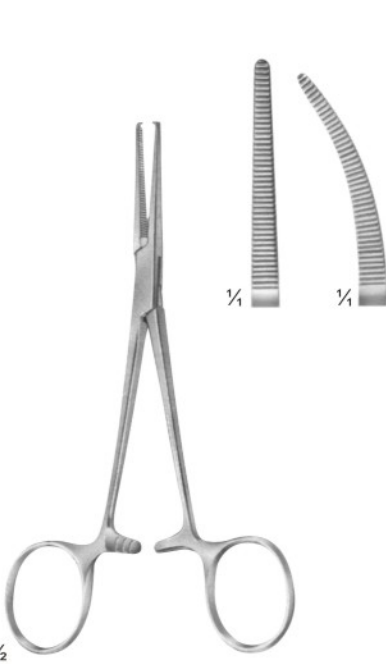

2550
CRILE
140 mm

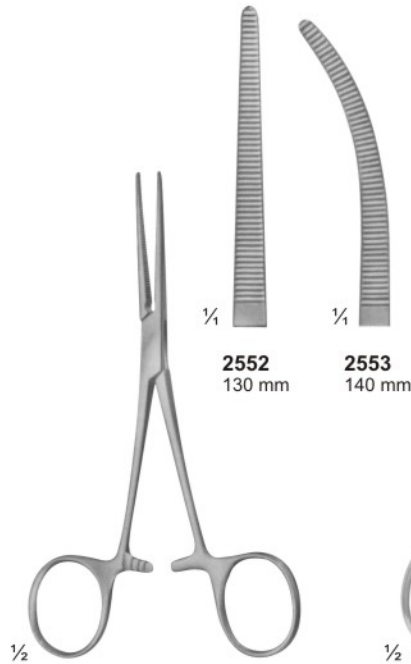

2551
PEAN
Slender type

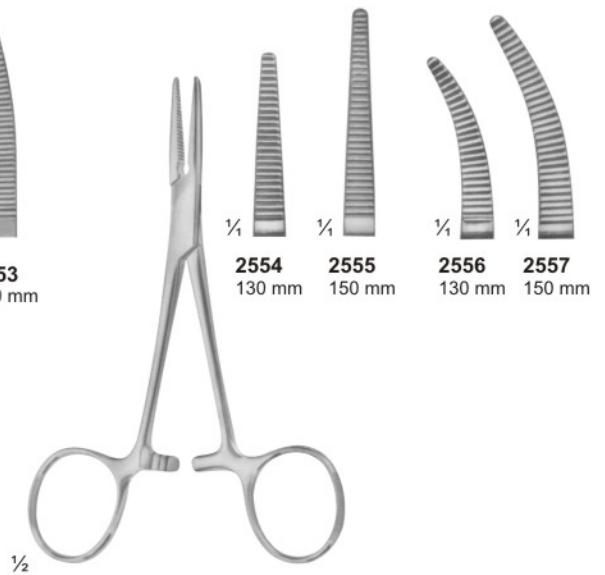

2554
SPENCER-WELLS

2552 130 mm
2553 140 mm
2554 130 mm
2555 150 mm
2556 130 mm
2557 150 mm

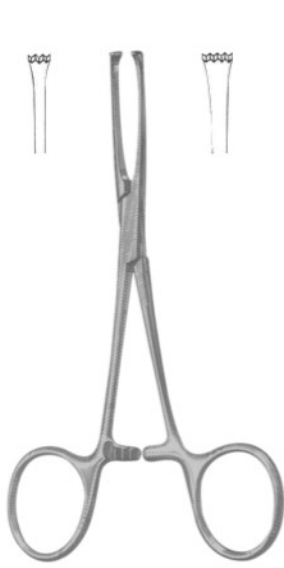

2558
BABY-ALLIS
5", Straight
4x5 teeth extra delicate

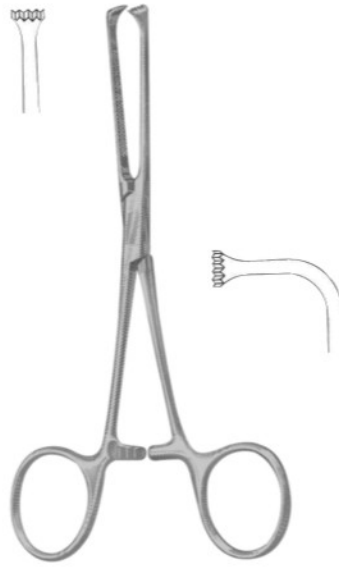

2559
ALLIS
6", Straight
4x5 teeth extra delicate

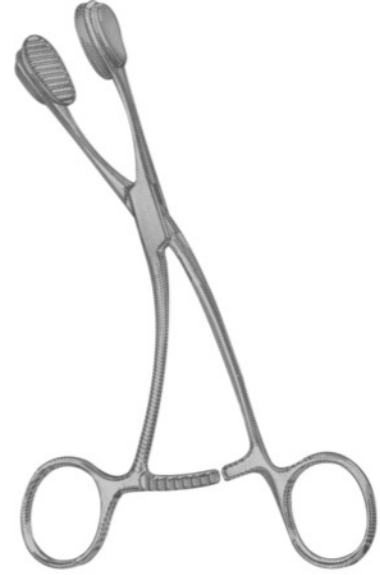

2560
ALLIS
6", Straight
4x5 teeth extra delicate



2561
1x2 teeth
6"



2562
SEMKIN
6", Straight,
1x2 teeth



2563
ADSON
4 3/4"
1x2 teeth



2564
BROWN-ADSON
4 3/4"
7x7 teeth



2565
BROWN
6"
8x8 teeth



2566
RUSSIAN
6"
8x8 teeth



2567
Extra-Delicate,
Straight, 4"
1x2 teeth

**Hemostatic Forceps,
Towel Clamps, Napkin Holders**



2568
HALSTED-MOSQUITO
Straight, Curved, 5"



2569
HALSTED-MOSQUITO
Straight, Curved, 5"
1x2 teeth



2570
HALSTED-MOSQUITO
Jaws 45 Angled on Flat, 5"
Extra Delicate



2571
KELLY
5 1/2", Straight

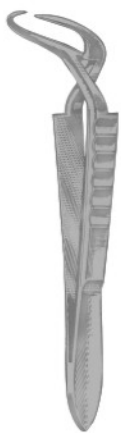

2572
JONES
3 1/2"



2573
BACKHAUS
3 1/2"



2574
BACKHAUS
5 1/4"

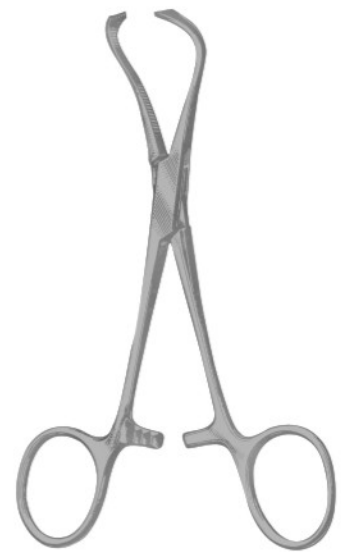

2575
LORNA
Non Perforated
3 1/2"

**Retractors, Depressors,
Mouth Gags**



2576
DENHART



$\frac{1}{2}$
2577
DENHARDT
Mouth Gag With
Silicon Inserts,
Interchangeable
Size: 125 mm

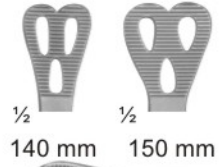

$\frac{1}{2}$ 140 mm $\frac{1}{2}$ 150 mm



$\frac{1}{2}$

2578
WIEDER
Tongue depressor
2579 140mm
2580 150mm

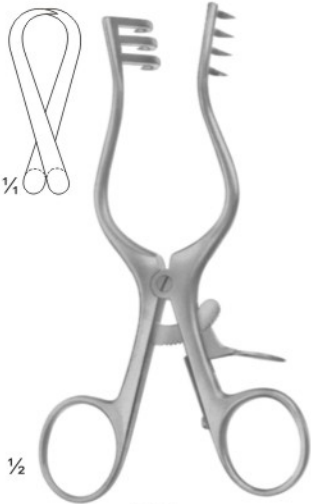

$\frac{1}{4}$

$\frac{1}{2}$

2583
WEITLANER
Sharp
130 mm

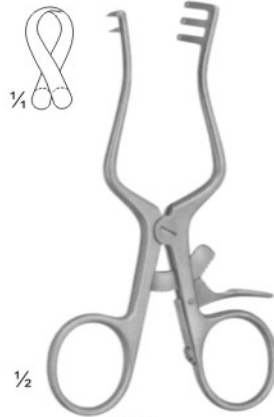

$\frac{1}{4}$

$\frac{1}{2}$

2584
WEITLANER
Sharp
110 mm

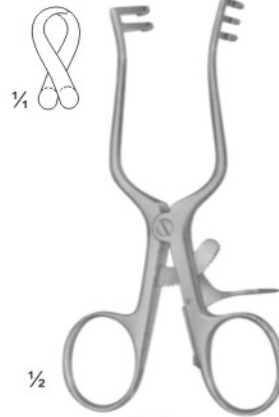

$\frac{1}{4}$

$\frac{1}{2}$

2585
WEITLANER
Semi-Sharp
110 mm



$\frac{1}{2}$

2581
TOBOLD
Tongue depressor
Size: 145 mm

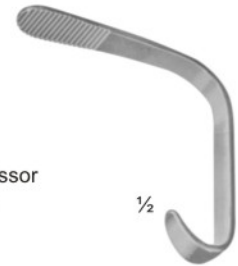

$\frac{1}{2}$

2582
ANDREW
Tongue depressor
Size: 110 mm



2586
MOLT
Pediatric



2587
MOLT
Child



2588
MOLT
Adult



$\frac{1}{2}$

2589
FERGUSSON-ACKLAND
Mouth Gag
Size: 145 mm



$\frac{1}{2}$

2590
ROSER KOENIG
Mouth Gag
Size: 160mm / 185mm

Lip & Cheek Retractors



2591
140 mm

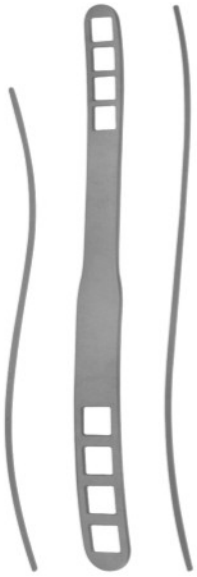

2592
BRUENINGS
190 mm



2593



2594



2595



2596



2597

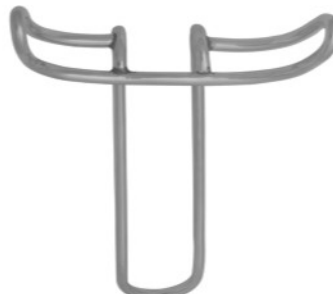

2598



2602

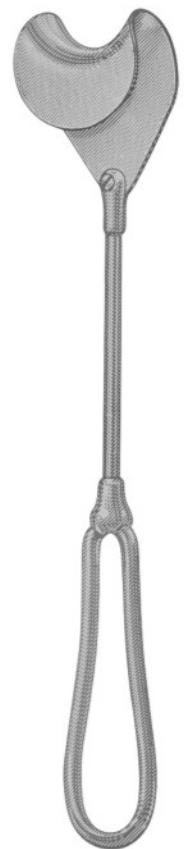

2603



2599
Mouth Gag with
Tongue Depressor
11.0 cm
13.0 cm
15.0 cm



2600
Mouth Gag without
Tongue Depressor
11.0 cm
13.0 cm
15.0 cm



2601
Jennings, Mouth Gag
11.0 cm
13.0 cm
15.0 cm

Lip & Cheek Retractor

- 30 x 4 mm A
- 23 x 7 mm B
- 24 x 11 mm C
- 29 x 10 mm D
- 30 x 11 mm E
- 32 x 14 mm F
- 40 x 11 mm G
- 42 x 10 mm H
- 50 x 11 mm I
- 55 x 11 mm J
- 60 x 11 mm K
- 70 x 11 mm L
- 70 x 14 mm M

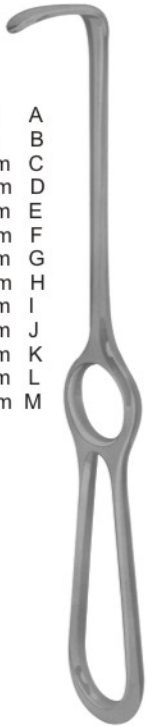

2604
LANGENBECK
210 mm



2605
KOCHER-LANGENBECK
215 mm



2606
BUCHS
205 mm



38 x 18 mm



2607
KOCHER
230 mm



2608
MIDDELDORPF



2609
15 x 15 mm
220 mm



2610
20 x 22 mm
215 mm



2611
28 x 28 mm
235 mm



2612
KOCHER
230 mm



2613
COLLIN
150 mm



2614
ROUX
Set
165 mm



2615
Sterilizing Forcep Curved
20 cm A
25 cm B
30 cm C



2616
Sterilizing Forcep Straight
20 cm A
25 cm B
30 cm C



2617
Sterilizing Forcep
30 cm



2618
Becht Tweezer



2619
Sterilizing Forcep
23 cm A
30 cm B



2620
Sterilizing Forcep
20 cm

Tissue Retractors & Hooks

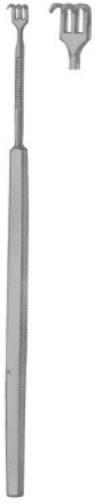

2621
3 sharp prongs



2622
2 sharp prongs
6"



2623
2 sharp prongs
6"



2624
FOMON
145 mm

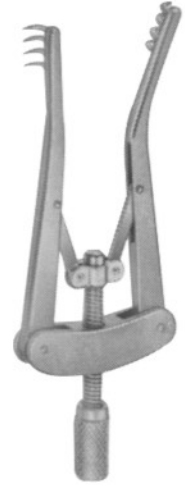

2625
ALM
70 mm



2626
SENN
3 sharp prongs
6 3/8"



2627
TOENNIS
Dura Retractor
150mm







2628
JOSEPH
165 mm

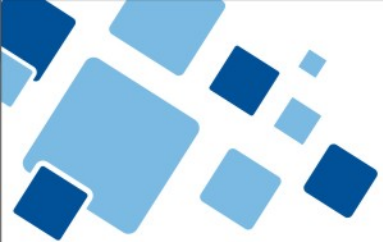

2629
GILLIES
180 mm



-  Orthodontic Pliers
-  Orthodontic Cutters
-  Rongeurs
-  Needle Holders



07

SECTION



Orthodontic Pliers



2630
Light Wire Cutter



2631
Wire Cutter



2632
Posterior Band Remover
Long



2633
Posterior Band Remover
Short



2634
Jarabak Plier



2635
Distal End Cutter
Safety End Cutter



2636
Distal End Cutter



2637
Kim's Plier



2638
Loop Forming Plier



2639
Tweed Arch Bending Plier



2640
Utility Plier



2641
Bonding Bracket Remover



2642
Lingual Arch Plier



2643
Light Wire Plier



2644
Wire Cutter
12.5 cm

Orthodontic Pliers

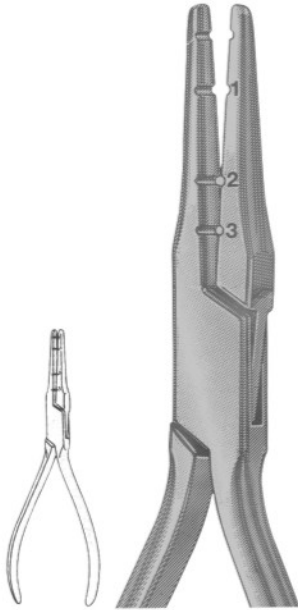

2645
Fig. 101
Wire Bending

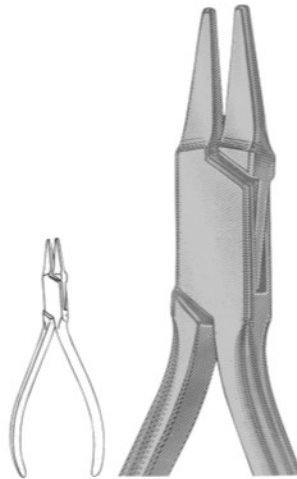

2646
Fig. 118
PEESO
Collar

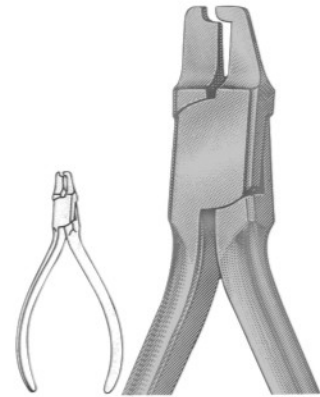

2647
Fig. 417
Crown Shell

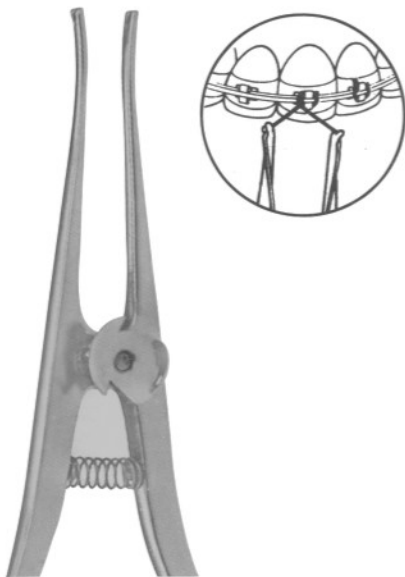

2648
STEINER
150 mm
Ligature Pliers

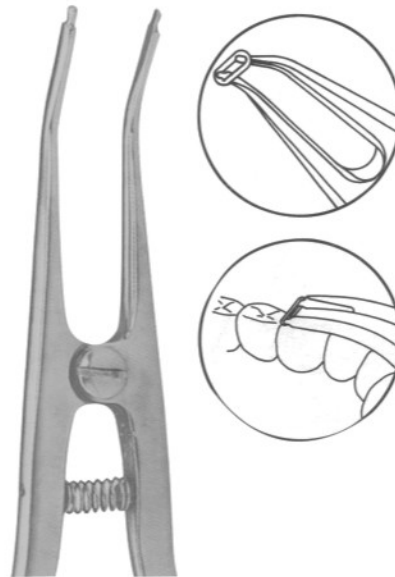

2649
Separating Pliers Elastics
150 mm

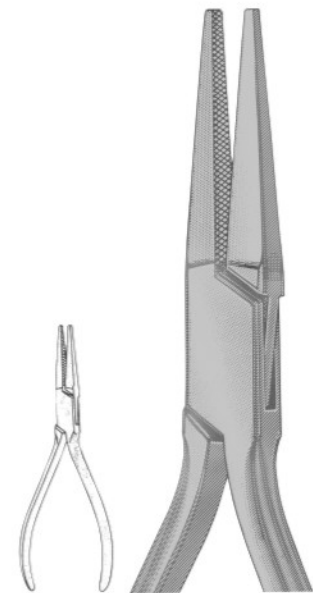

2650
121-Lab & Office

Orthodontic Pliers

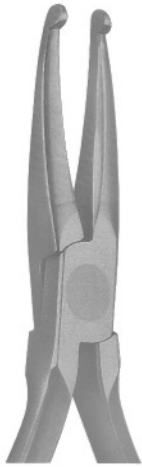

2651
How Plier-Titanium Alloy
With special coated beaks

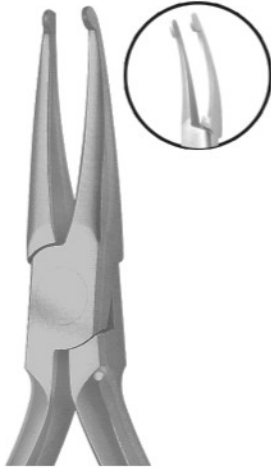

2652
How Plier
Tips are 1/8"(3.2mm)
diameter

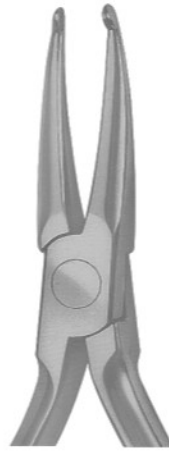

2653
How Plier
Tips are 1/8"(3.2mm)
diameter



2654
How Plier-Small
Tips are 3/32"(2.4mm)
diameter

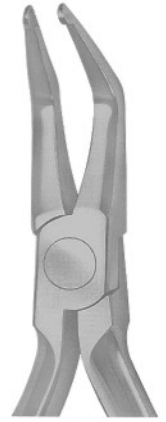

2655
How Plier-Offset
Tips are 1/8"(3.2mm)
diameter

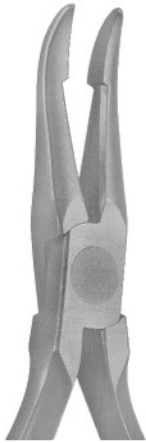

2656
Weingart Utility Plier
-Titanium Alloy
with special coated beaks

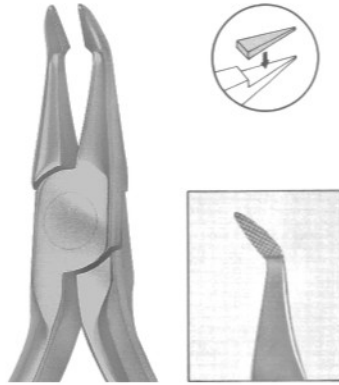

2657
Weingart Utility Plier
New type of the Weingart Utility Plier
designed for a more precise operation.

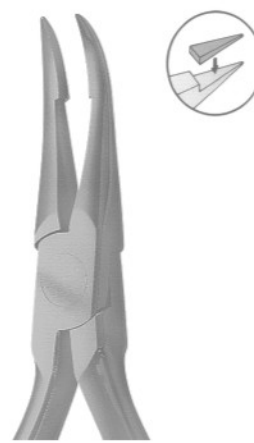

2658
Weingart Utility Plier

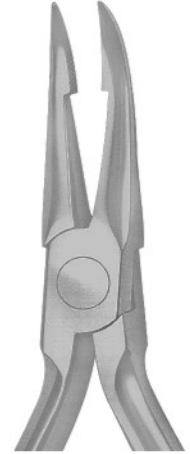

2659
Weingart Utility Plier

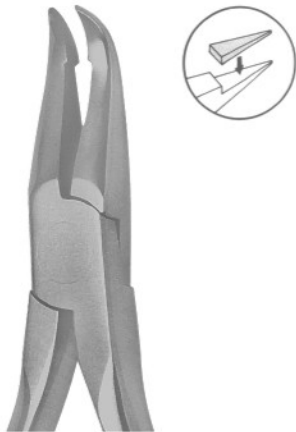

2660
Weingart Utility Plier

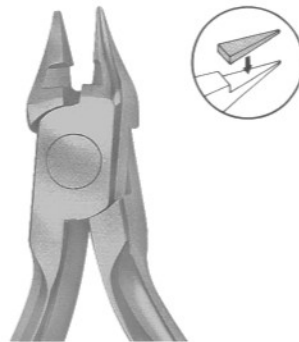

2661
Bird Beak Plier With Cutter
Maximum Bending & Cutting Capacity:
Wires up to .032"

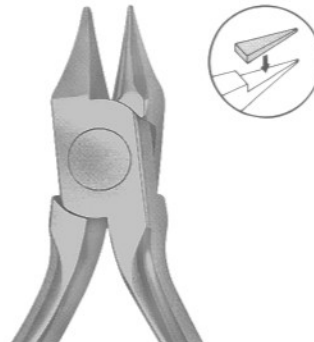

2662
Bird Beak Plier
Maximum Bending Capacity:
Wires up to .032"

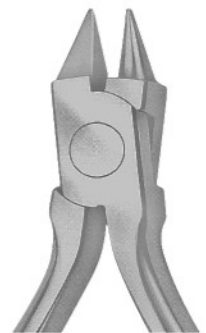

2663
Bird Beak Plier
Maximum Bending Capacity:
Wires up to .030"

Orthodontic Pliers



2664
TWEED (Fig. 98)
13 cm, 5 1/8"
Tweed Loop Omega Pliers.



2665
TWEED - (Fig. 90)
14 cm, 5 1/2"

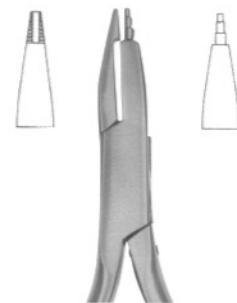

2666
O'BRIEN - (Fig. 97)
14 cm, 5 1/2"

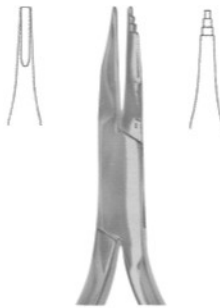

2667
TWEED (Fig. 96)
14 cm, 5 1/2"

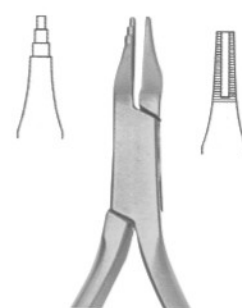

2668
TWEED (Fig. 95)
13.5 cm, 5 1/4"

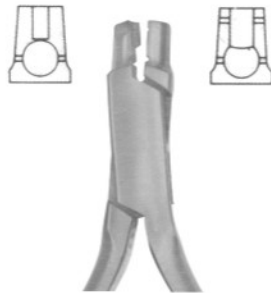

2669
SCHWARZ (Fig. 29)
12.5 cm, 5"

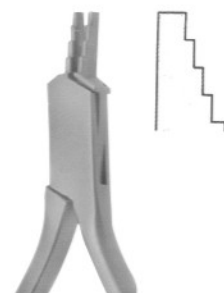

2670
NANCE (Fig. 80)
13 cm, 5 1/8"

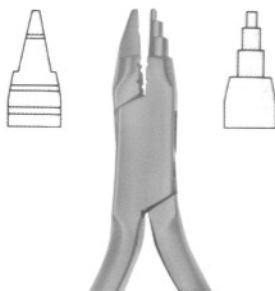

2671
YOUNG (Fig. 55)
13 cm, 5 1/8"



2672
SCHWARZ (Fig. 30)
13 cm, 5 1/8"

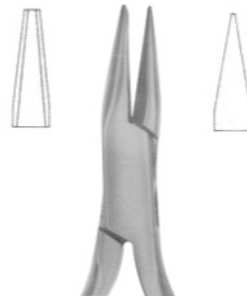

2673
Optical Plier (Fig. 53)
14 cm, 5 1/2"

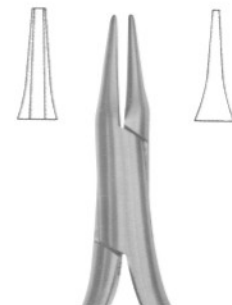

2674
Schwarz (Fig. 79)
13.5 cm, 5 1/4"

Orthodontic Pliers



2675
NANCE (Fig. 56)
12.5 cm, 5"
Wire bending Pliers



2680
14.0 cm
Goslee Contouring Plier



2676
JOHNSON (Fig. 59)
13.5 cm, 5 1/4"
Contouring Plier.



2677
REYNOLDS (Fig. 61)
13 cm, 5 1/8"
Contouring Plier.



2678
De La Rosa (Fig. 34)
12.5 cm, 5"
Contouring Plier, Non-Grooved



2679
De La Rosa (Fig. 35)
12.5 cm, 5"
Contouring Plier, Grooved

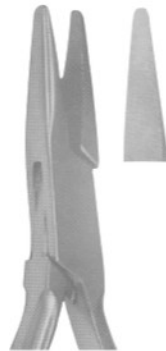

2681
14.0 cm
Goslee Contouring Plier



2682



2683
Fig. 58
12.5 cm, 5"
Lingual Arch Bending Plier

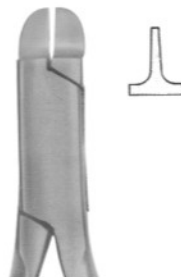

2684
Frevert/Tweed (Fig. 51)
12.5 cm, 5"
Tweed Arch Plier/Standard Jaw

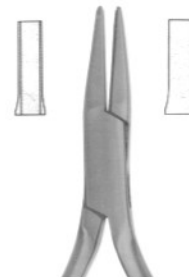

2685

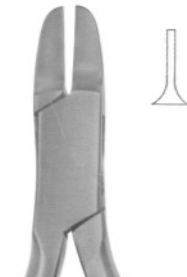

2686
ANGLE (Fig. 52)
13 cm, 5 1/8"
Arch Forming Plier



2687
Fig. 60
13 cm, 5 1/8"
Wire & Clasp Bending Pliers

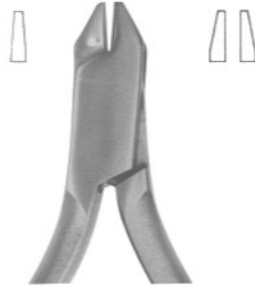

2688
Fig. 60
13 cm, 5 1/8"
Wire & Clasp Bending Pliers

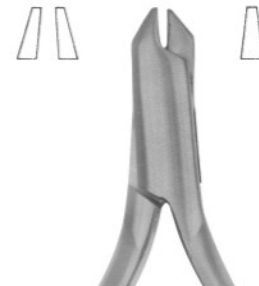

2689
Aderer (Fig. 57)
12 cm, 4 3/4"
Wire & Clasp Bending Pliers



2690
49 e 49 TC
14 cm, 5 1/2"
Band Removing Plier, short pad



2691
50 e 50 TC
14 cm, 5 1/2"
Band Removing Plier, long pad

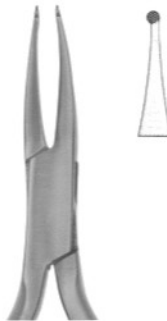

2692
Fig. 84
14.5 cm, 5 3/4"
Band pinshing & ligature
locking plier, serrated

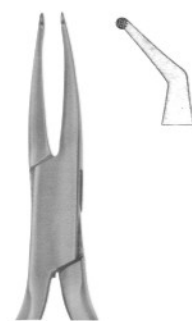

2693
Fig. 72
14 cm, 5 1/2"
Band pinshing & ligature
locking plier, serrated



2694
BRACKET (Fig. 82)
13.5 cm, 5 1/4"
Direct Bonding Bracket Remover



2695
BRACKET (Fig. 83)
13.5 cm, 5 1/4"
Direct Bonding
Bracket Remover

Orthodontic Pliers



2696
38c, 38TC
13.5 cm, 5 1/4"
Contouring closing loop pliers,
wire bending, cutter.

2697
40c, 40TC
13.5 cm, 5 1/4"
Contouring pliers light wire pliers
grooved with cutter.

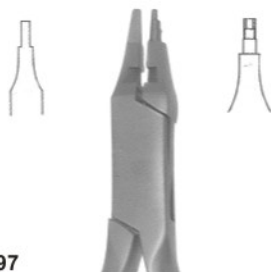

2698
Fig. 81
12.5 cm, 5"
Sling clasp & wire bending plier

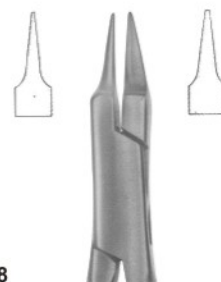

2699
Fig. 28
14 cm, 5 1/2"
Sling clasp & wire bending plier.

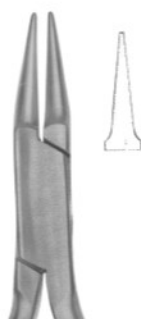

2700
Fig. 21
13 cm, 5 1/8"
Light wires pliers, grooved

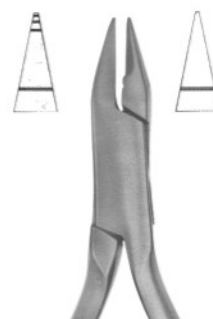

2704
46c - 46 TC
ADAMS - N. 139c
12.5 cm, 5"
Bird beak with cutter.

2701
ADAMS, 23, 23TC
12.5 cm, 5"
Sling clasp & wire bending plier.

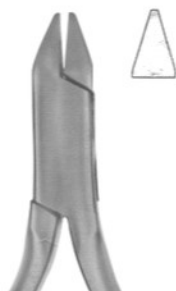

2702
ADAMS (Fig. 33)
12.5 cm, 5"
For retaining elements.

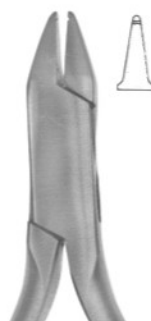

2703
ADAMS (Fig. 44)
12.5 cm, 5"
Sling clasp & wire bending plier.

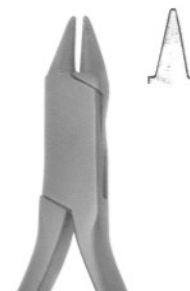

2705
Universal Wire Bending
Pliers (ADAMS) 47 TC, N.64
12.5 cm, 5"
Sling clasp & wire bending plier.



2706
86c, 86 TC
Angle Bird Beak - N.138
12.5 cm, 5"
Sling clasp & wire bending plier.

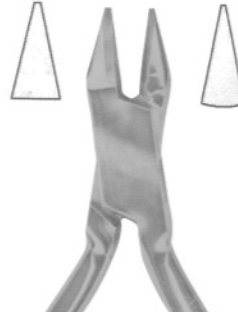

Orthodontic Cutters With T.C.



Ø 1.0 mm
(0.40")

2707
Fig. 18 TC
15 cm, 6"



Ø 1.0 mm
(0.40")

2708
Fig. 92 TC
14 cm, 5 1/2"



Ø 0.4 mm
(0.16")

2709
Fig. 91 TC
13 cm, 5 1/8"



Ø 0.4 mm
(0.16")

2710
Fig. 99 TC
13 cm, 5 1/8"



Ø 0.4 mm
(0.16")

2711
Fig. 94 TC
13 cm, 5 1/8"
Angled at 15° with or
without spring on \
the handles.



2712
Fig. 85 TC
13 cm, 5 1/8"



2713
Fig. 87 TC
13 cm, 5 1/8"



2714
Fig. 85 TC
Angled at 15
13 cm, 5 1/8"



2715
ADAMS 87 TC
Angled at 15
13 cm, 5 1/8"

Orthodontic Distal & Cutters

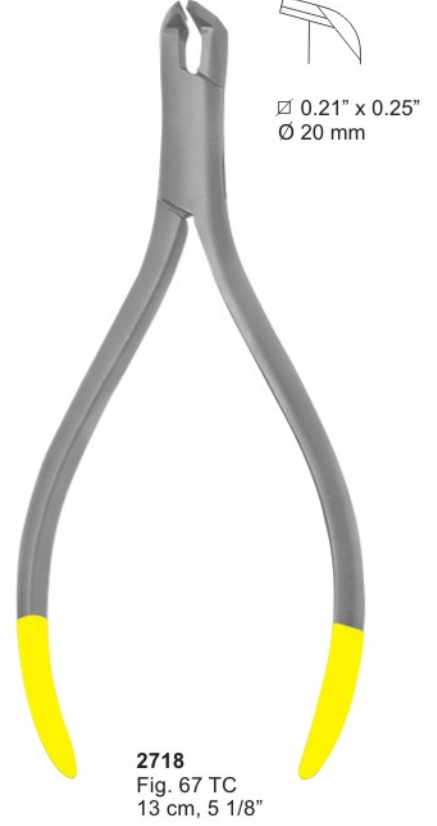
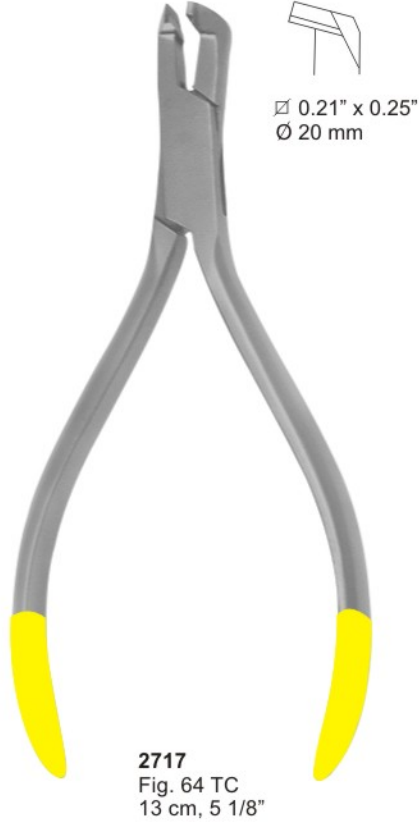
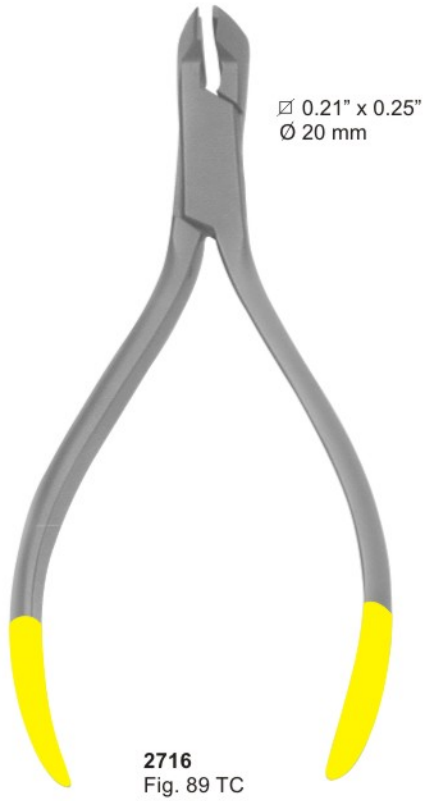

Pliers for Orthodontic & Prosthetics



2721
UNIVERSAL
150 mm

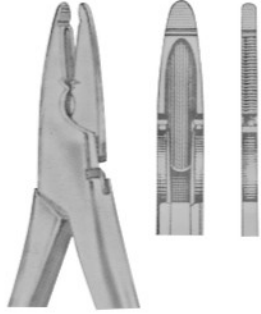

2722
WALDSACHS
155 mm



2723
ADERER
125 mm

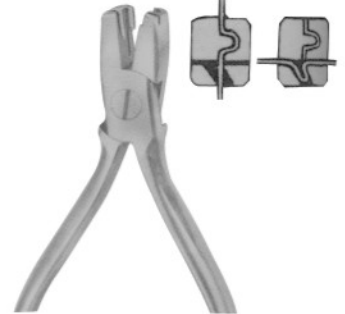

2724
NANCE
125 mm



2725
REYNOLDS
125 mm



2726
HOW
145 mm



2727
HOW
140 mm



2731
FURRER
150 mm

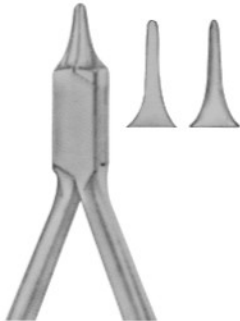

2728
WALDRON
125 mm

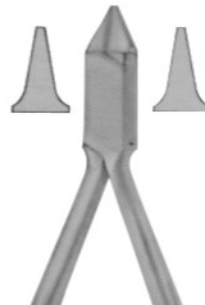

2729
ADAMS
125 mm

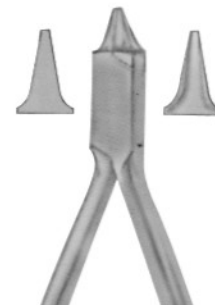

2730
ANGLE
125 mm

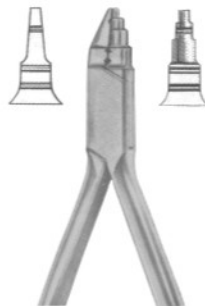

2732
YOUNG
130 mm

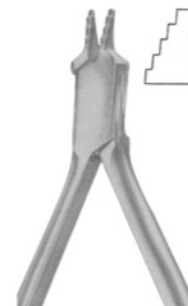

2733
NANCE
130 mm

Pliers for Orthodontic & Prosthetics

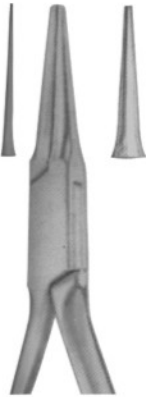

2734
LANGEBECK
125 mm

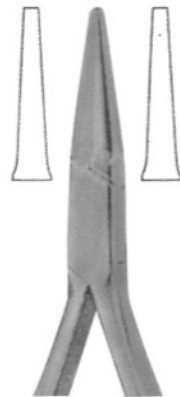

2735
LANGEBECK
140 mm

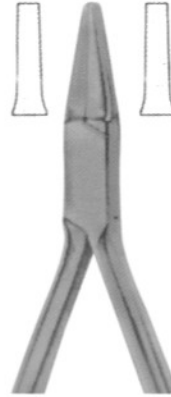

2736
LANGEBECK
130 mm

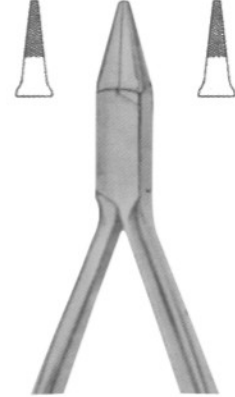

2737
PEESO
125 mm

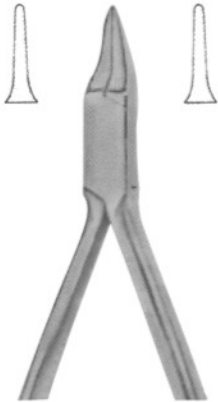

2738
GOSLEE
125 mm

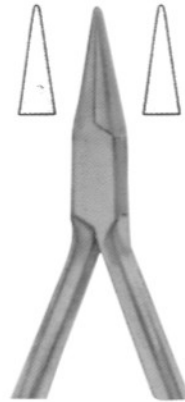

2739
FISCHER
140 mm

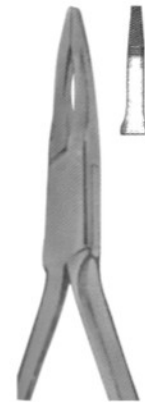

2740
FISCHER
140 mm

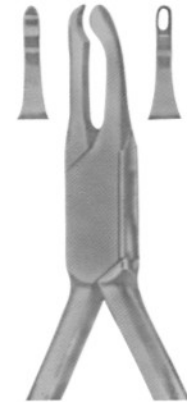

2741
JOHNSON
130 mm

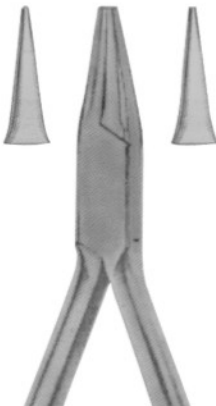

2742
MSY
130 mm



2743
MC KELLOPS
155 mm



2744
ANDRESEN
130 mm

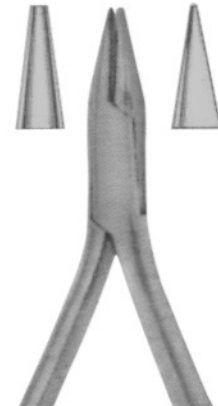

2745
SCHWARZ
130 mm



2746
BLUMENTHAL
6", 30°, Standard

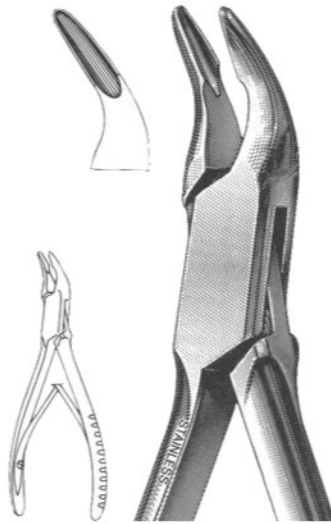

2747
MINI-BLUMENTHAL
6", 45°

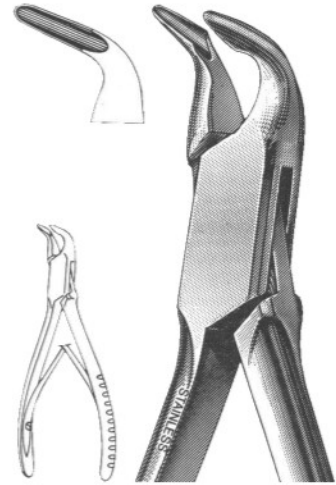

2748
MINI-BLUMENTHAL
6", 90°

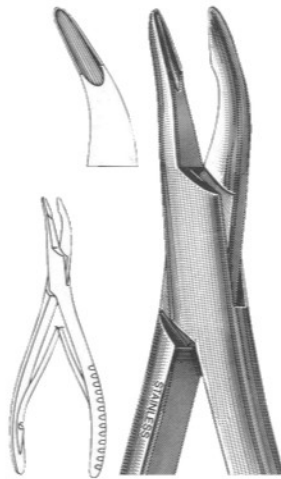

2749
BLUMENTHAL
7", 30°

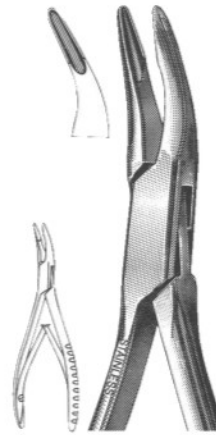

2750
MINI-BLUMENTHAL
4 1/2", 30°

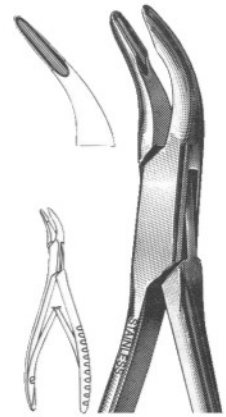

2751
MINI-BLUMENTHAL
4 1/2", 45°



2752
CLEVELAND
No. 5-Side Cutting,
6 3/4"

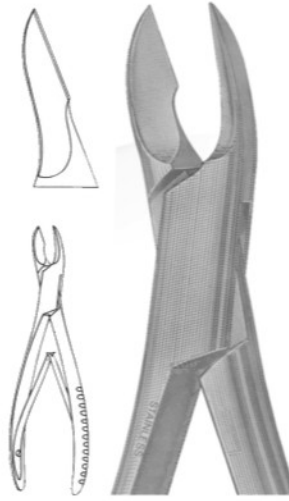

2753
CLEVELAND
No. 5A-Side Cutting,
6 1/2"

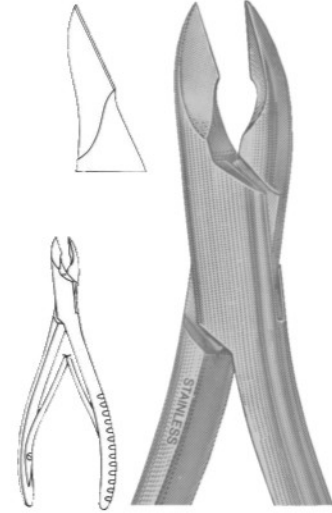

2754
CLEVELAND
No. 5S-Side Cutting,
6"

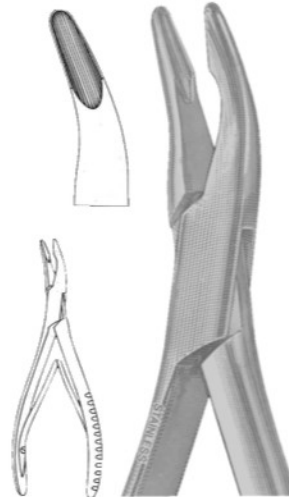

2755
MEAD, Square
No. 1A-MEAD
6 1/2"

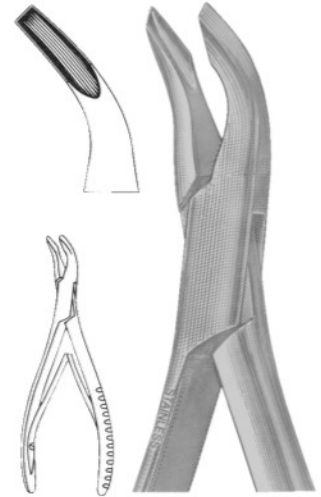

2756
MEAD, Square
No. 2A
Tips, 6 1/2"

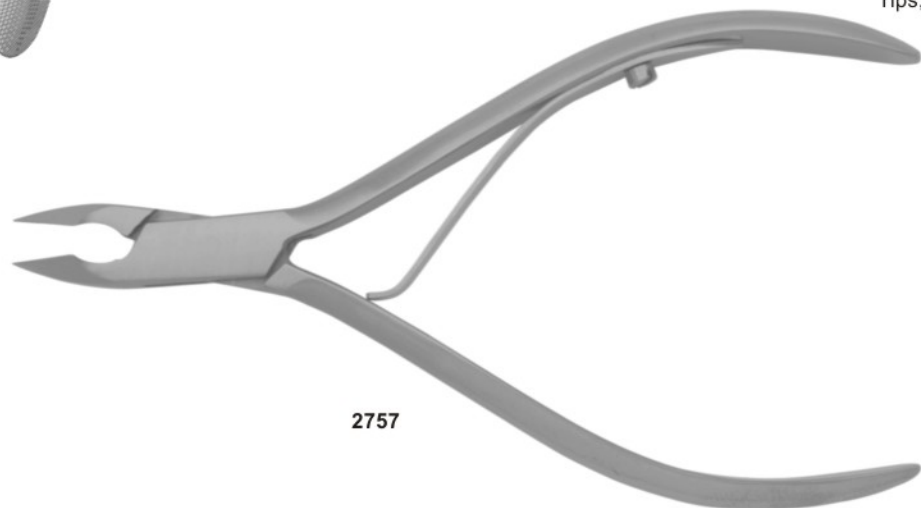

2757



2757
FRIEDMAN
5 1/2"

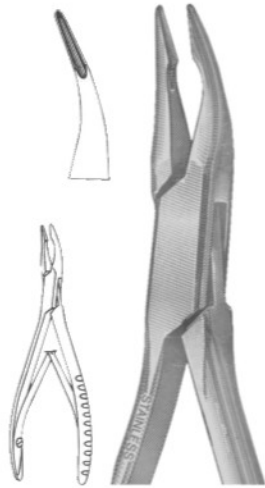

2758
MICRO-FRIEDMAN
5 1/2", 15° Curved Jaws

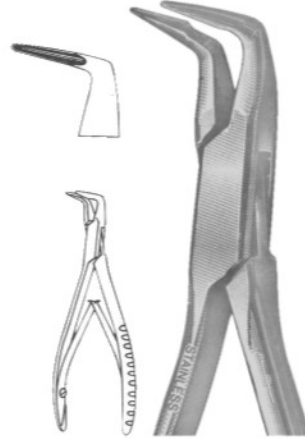

2759
MICRO-FRIEDMAN
Perio Rongeur, 5 1/2"

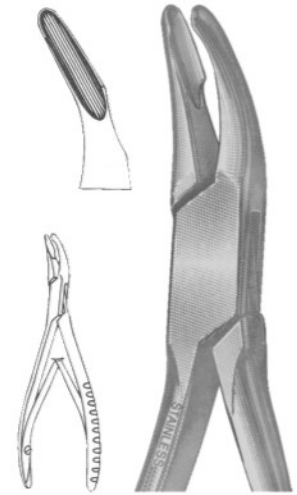

2760
CLEVELAND
No. 4 - 5 1/2"

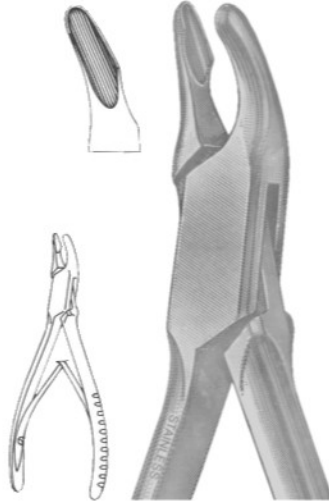

2761
CLEVELAND
No. 4A - 6 1/2"

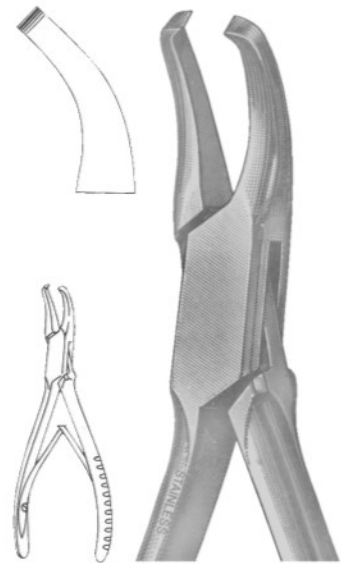

2762
GARDNER
No. 6A, End Cutting
6 1/2"



2763
BEYER
Double Action,
16, 18 cm



2764
No. 1
6 1/2"

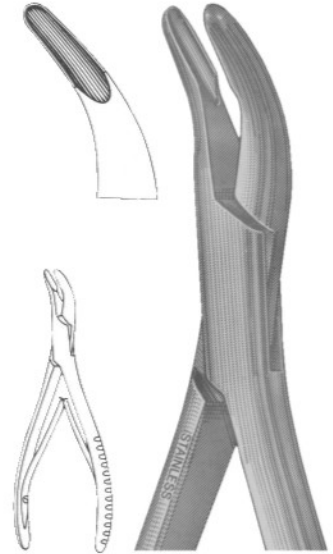

2765
HARTMAN
5 3/4"
Strong Curve

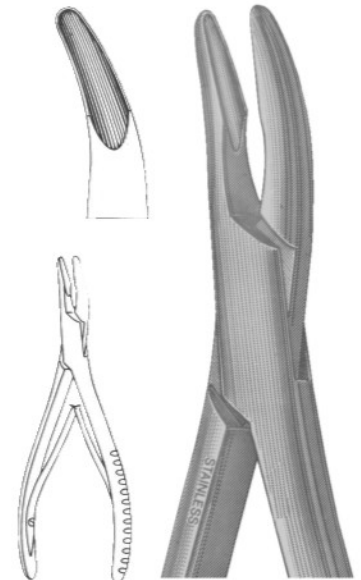

2766
BANE
Slight Curve
7"

Needle Holders



2767
COLLIER
5", Fenestrated Jaws



2768
DERF
4 3/4"

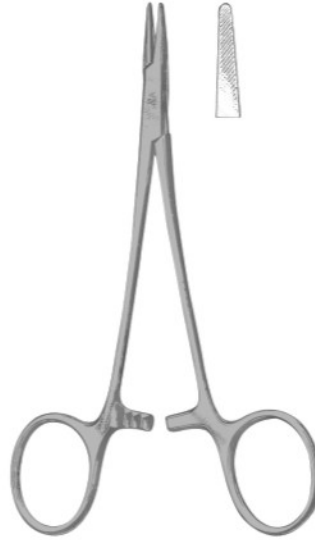

2769
WEBSTER
Delicate Smooth Jaws
5"

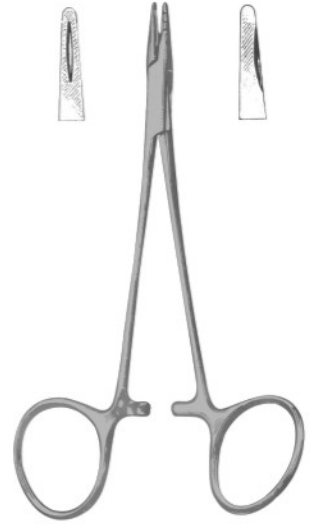

2770
NEIVERT
One Offset Ring
5"



2771
OLSEN-HEGAR
5 1/2"



2772
BAUMGARTNER
5 1/2"



2773
CRILE-WOOD
6"



2774
GARDNER
5"

Needle Holders



2775
MAYO-HEGAR
5"



2776
CASTROVIEJO
Smooth Jaws
14 cm



2777
CASTROVIEJO
Smooth Jaws
14 cm



2778
CASTROVIEJO
Smooth Jaws
14 cm



2778
CASTROVIEJO
Smooth Jaws
14 cm

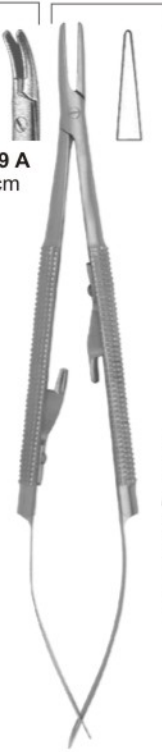

2779 A
18 cm



2780 A
18 cm



2781
BOYNTON
5"



2782
CRILE
6"



2783
MATHIEU
5 1/2"



2784
STEVENS
6 1/2"

Micro Surgery Set



2785
Micro Scissor
Straight, 155 mm



2786
Micro Scissor
Straight, 150 mm



2787
Micro Scissor
Curved, 150 mm



2788
Micro Scissor
Curved, 155 mm



2789
CASTROVIEJO
T.C.
Straight, 180 mm



2790
Retractor
Fig.3
165 mm



2791
Micro Adson
120 mm



2792
GERALD
Curved,
180 mm



2793
GERALD
Straight,
175 mm



2794
Micro Adson
160 mm

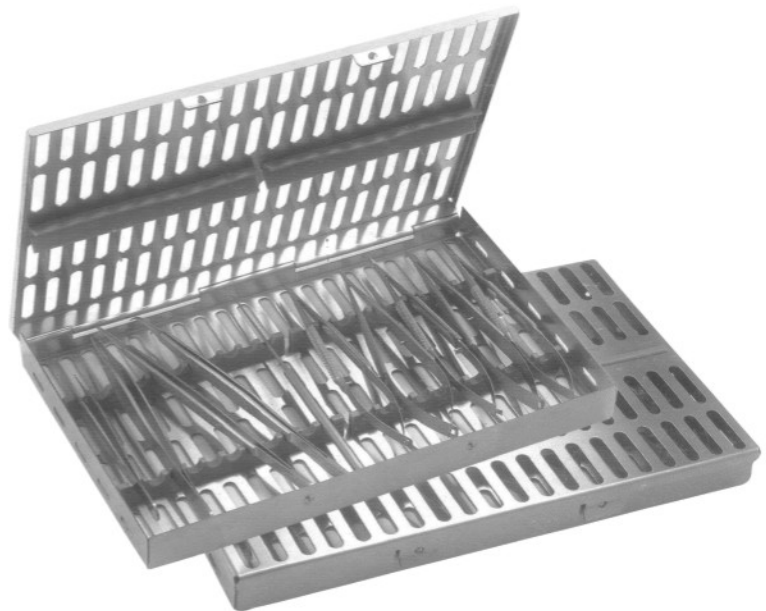

2795
Micro Surgery Set 10 Pieces.

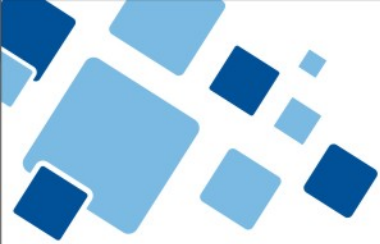

- ⟨☞ Scissors
- ⟨☞ Impression Trays
- ⟨☞ Articulators
- ⟨☞ Hollow Wares
- ⟨☞ T.C. Instruments



08
SECTION



Scissors

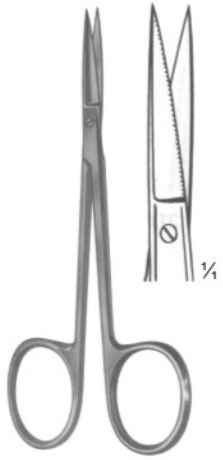

2796
IRIS (Standard)
Straight
11.5 cm, 4 1/2"

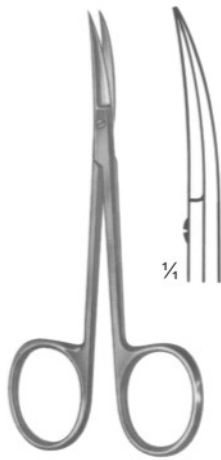

2797
IRIS (Standard)
Curved
11.5 cm, 4 1/2"



2798
STEVENS
Dissecting Scissors
Size: 115 mm

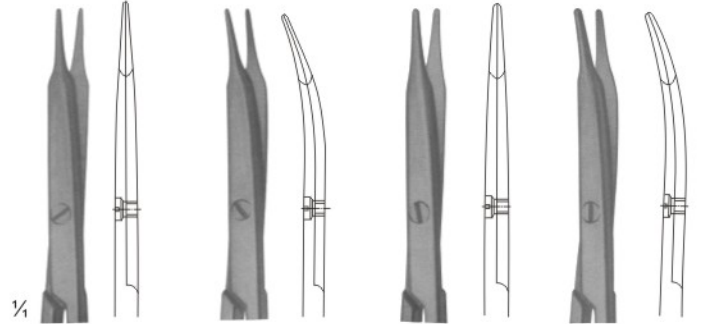

2799
Sharp

2800
Sharp

2801
Blunt

2802
Blunt



2803



2804
JOSEPH
Size: 150 mm

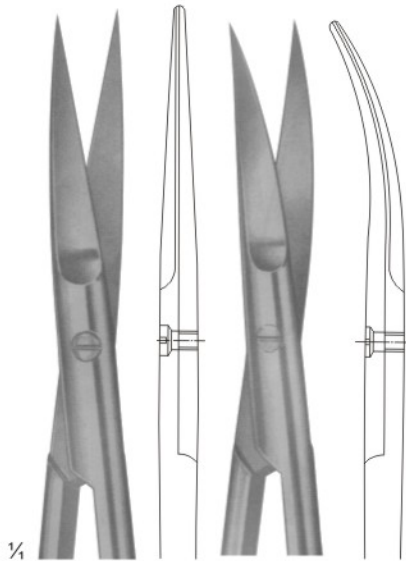

2805

2806

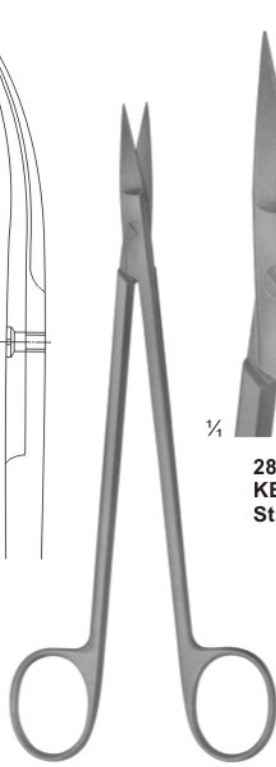

2807
KELLY
Size: 175 mm

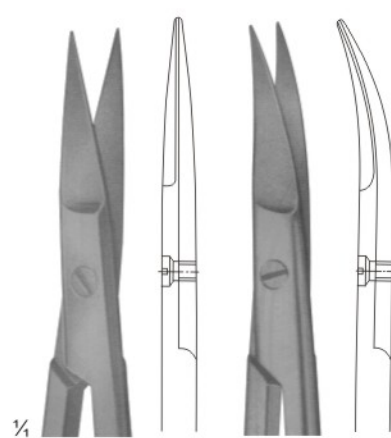

2808
KELLY
Straight

2809
KELLY
Curved

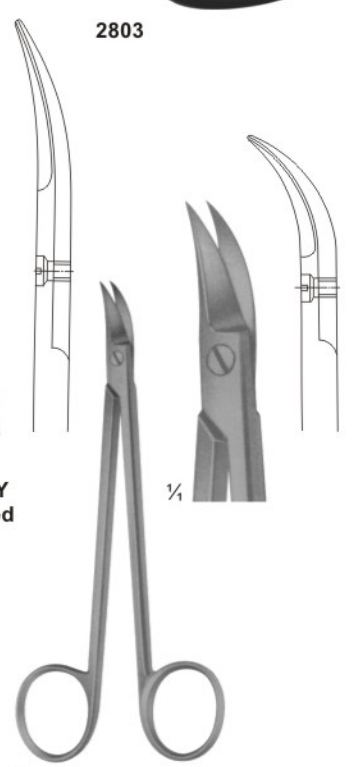

2810
QUINBY
Size: 130 mm

Scissors

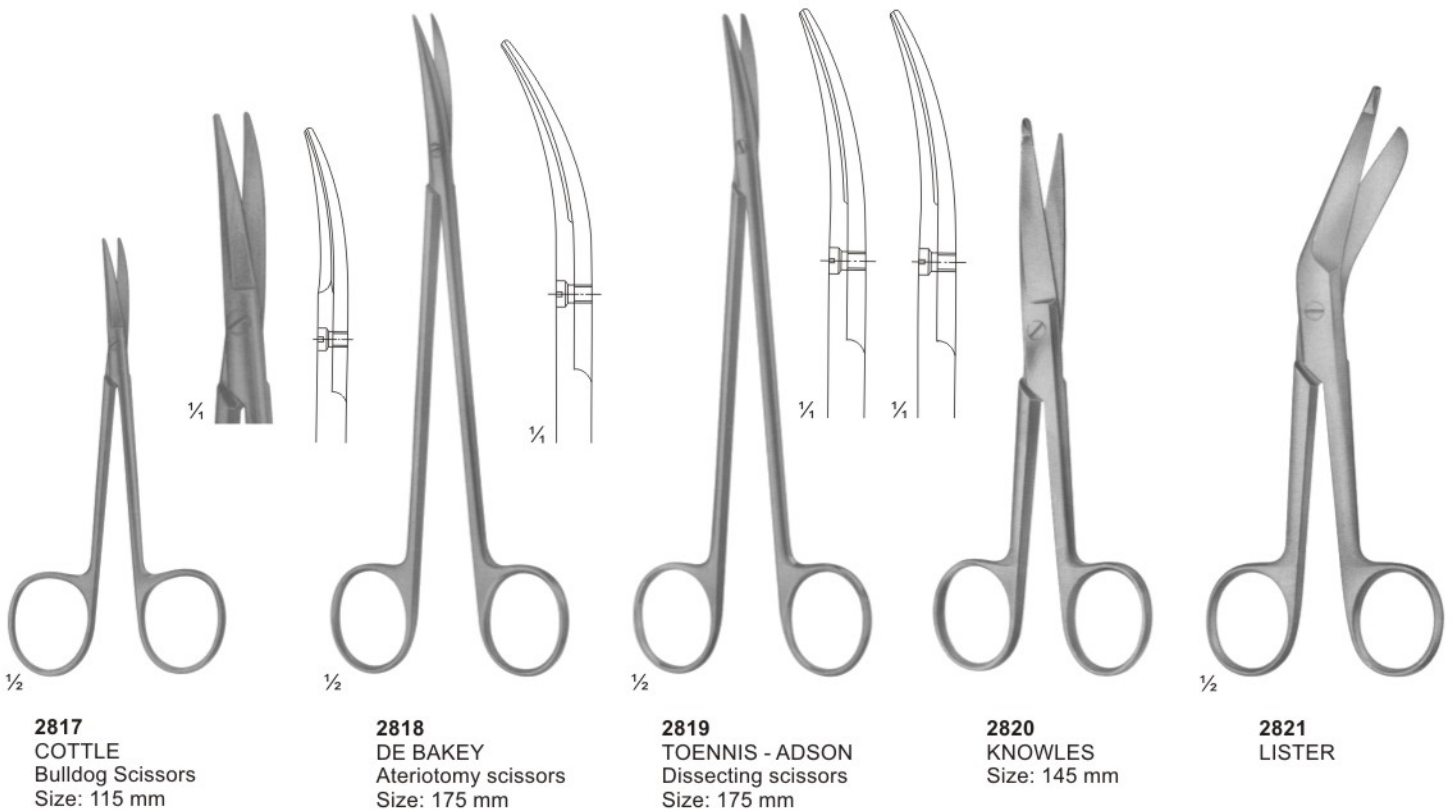
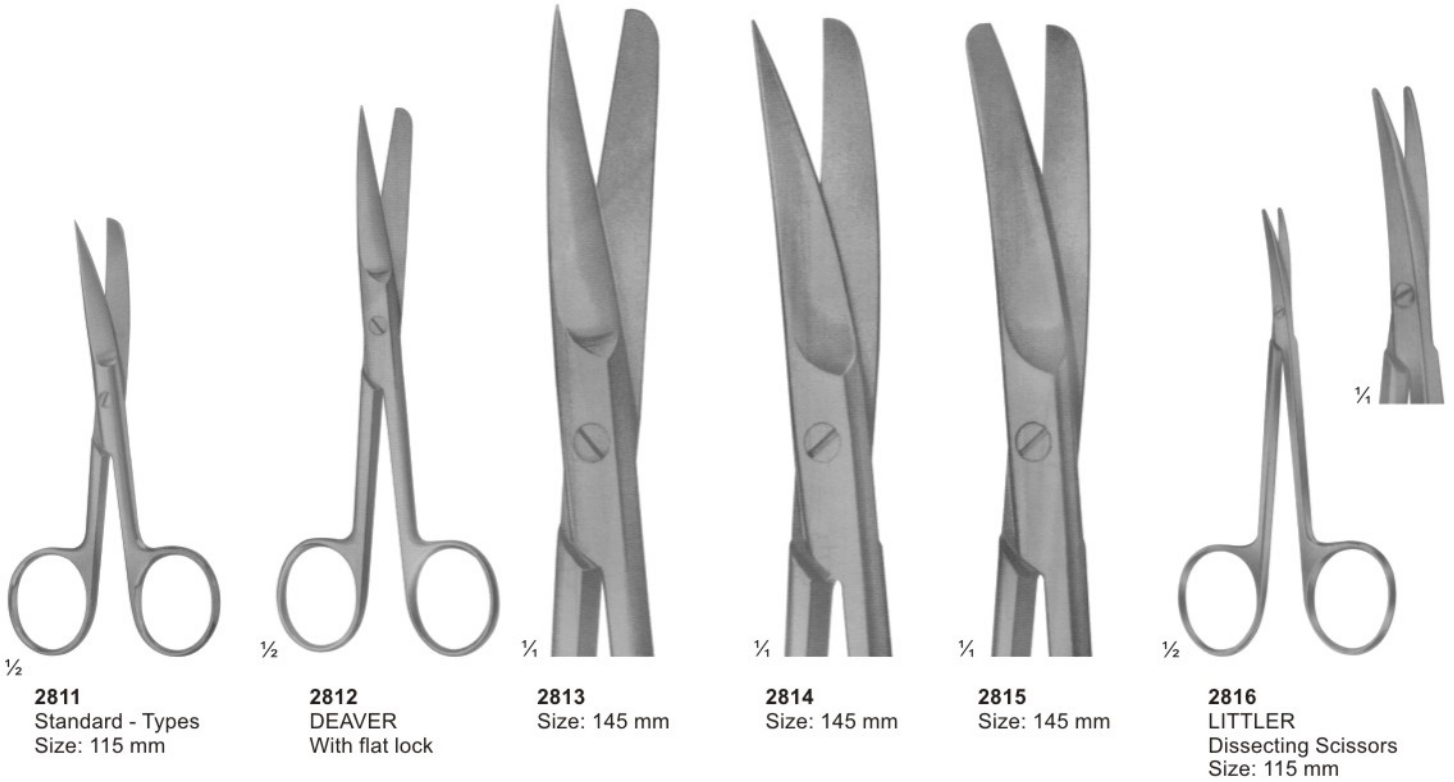

Scissors

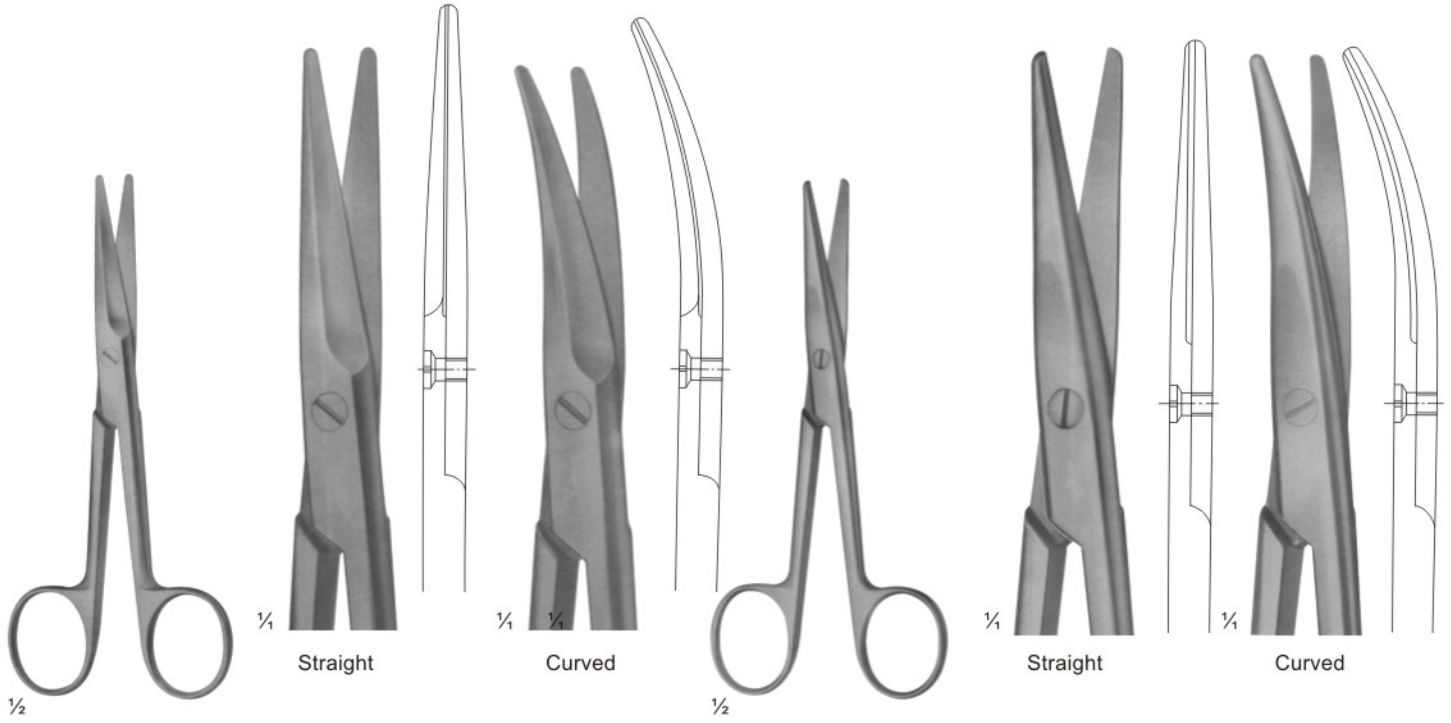

Straight

Curved

Straight

Curved

2822
MAYO(straight)
Size: 140 mm

2823
MAYO-STILLE (straight)
Size: 140 mm

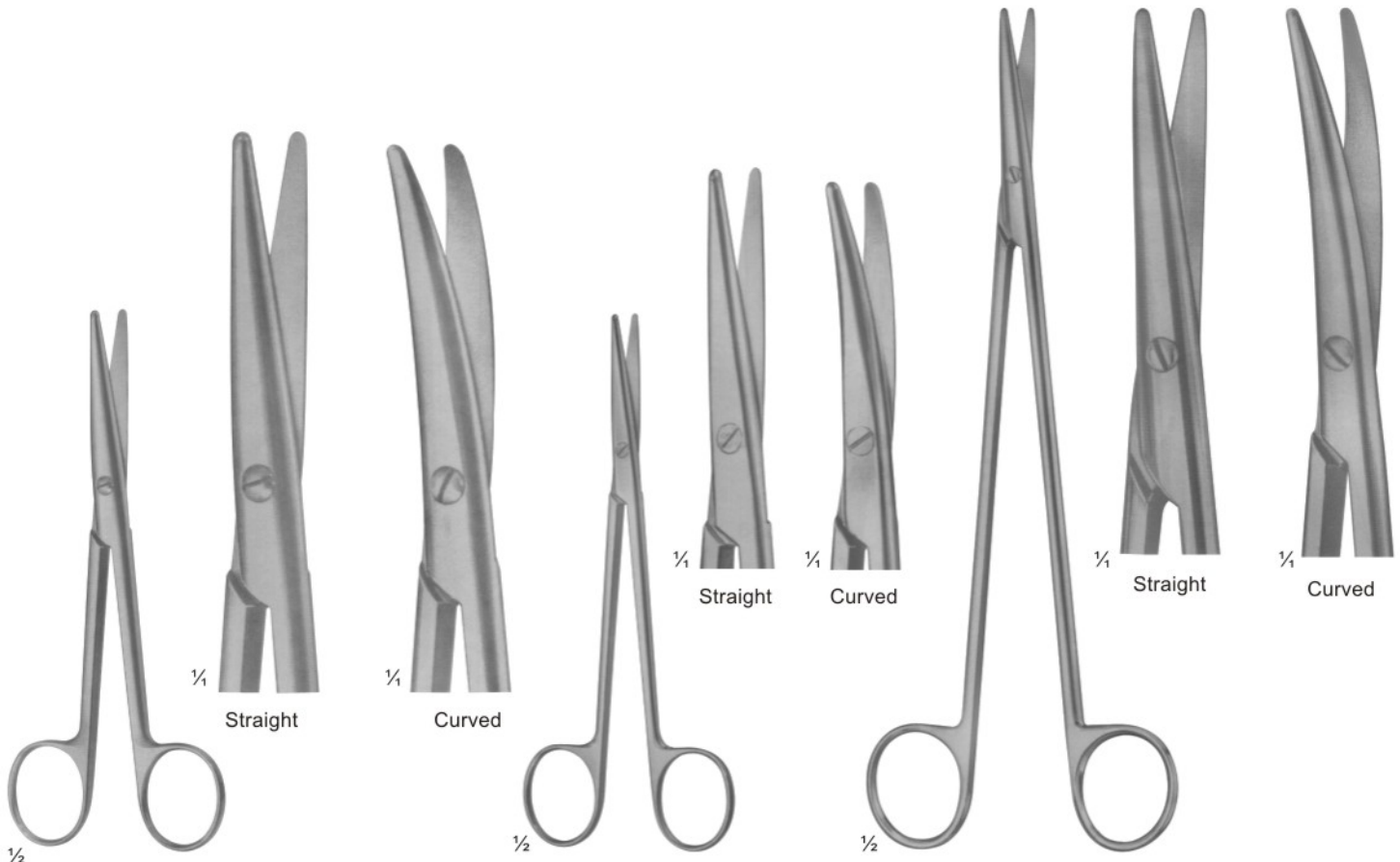

Straight

Curved

Straight

Curved

Straight

Curved

2824
STILLE
Size: 140 mm

2825
METZENBAUM
Size: 145 mm

2826
NELSON-METZENBAUM
Size: 230 mm

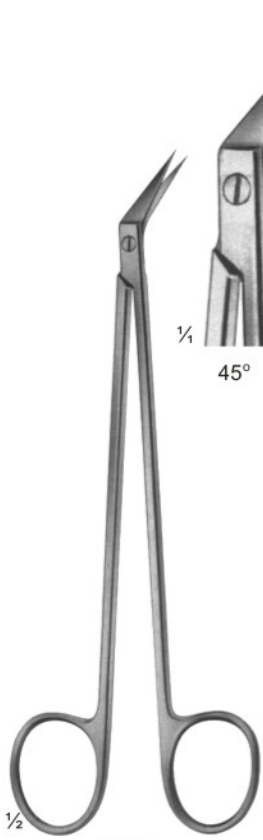

2827
DE BAKEY
Size: 155 mm

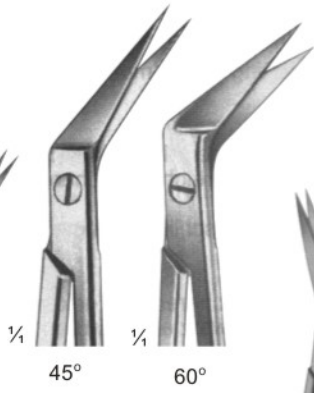

2828
LOCKLIN
Curved Sideways,
1 Toothed Blade
Size: 155 mm



2829
LaGrange
Double-Curved
11.5 cm



2830
Goldman-Fox
Double-Curved
13cm



2831
SPENCER
Size: 90 mm

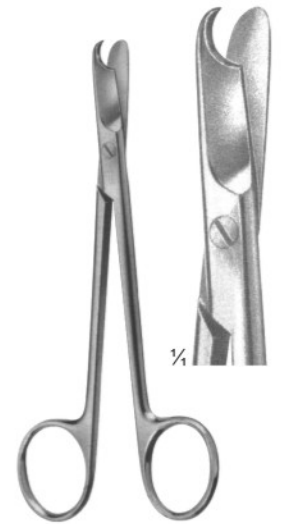

2832
LITTAUER
Size: 135 mm

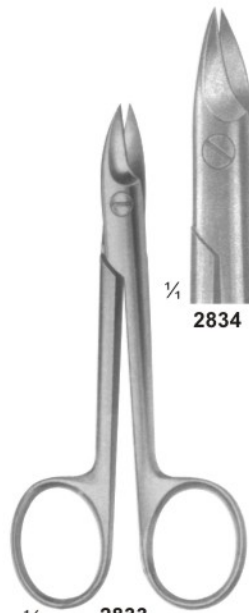

2833
BEEBE
Size: 110 mm

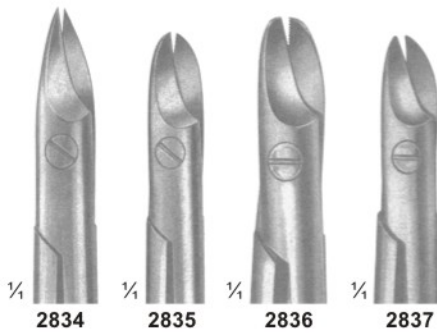

2834

2835

2836

2837



2838
Dean
17cm

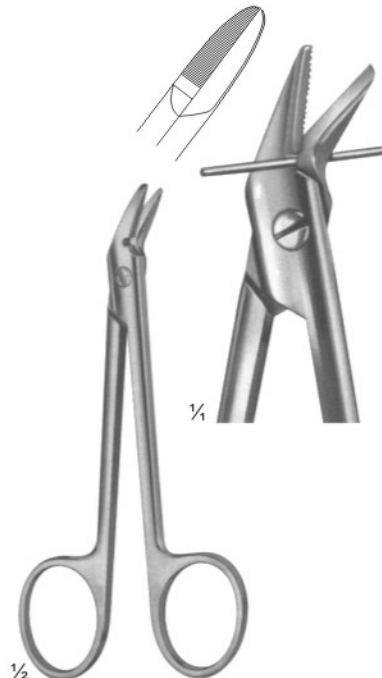

2839
1 Blade Serrated
Size: 120 mm

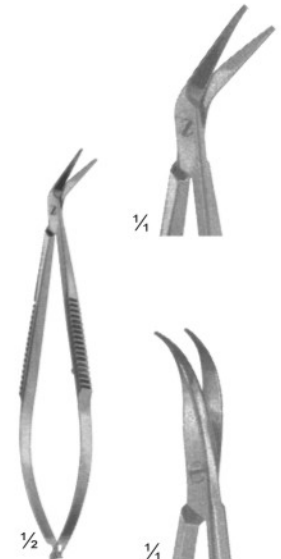

2840
CASTROVIEJO
Size: 90 mm

Impression Trays

Made of 18/8 Stainless Steel, Solid, Set of 10

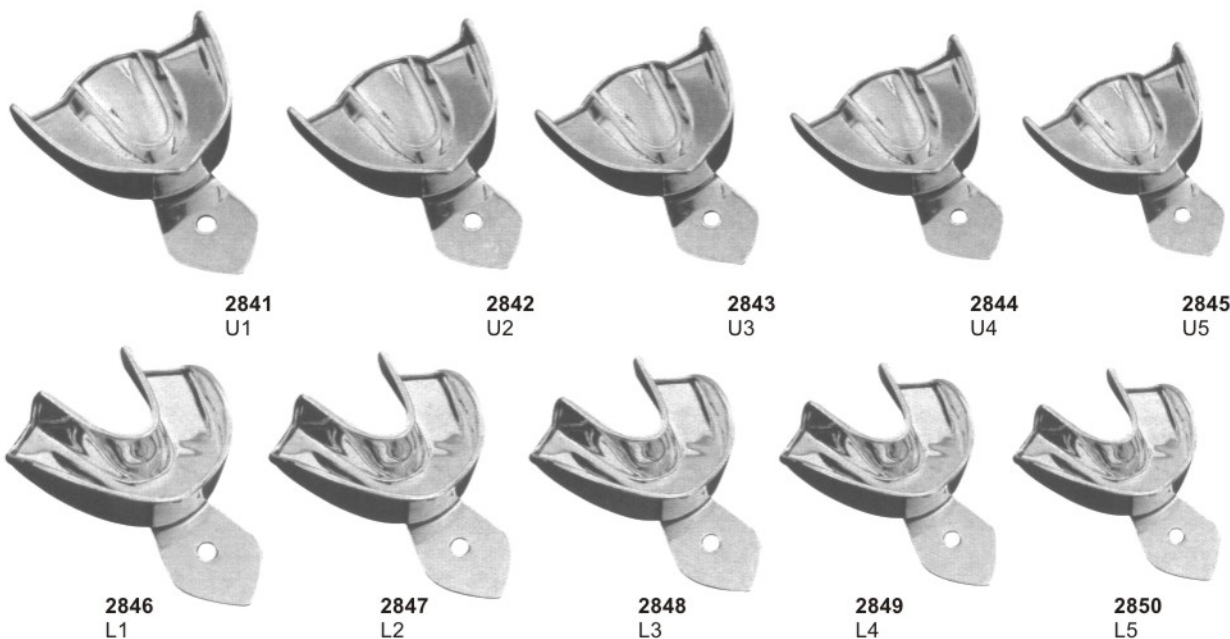

2841
U1

2842
U2

2843
U3

2844
U4

2845
U5

2846
L1

2847
L2

2848
L3

2849
L4

2850
L5

All The Above Impression Trays are Available in These 5 Sizes

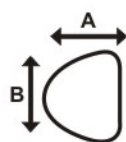

| UPPER | | U1 | U2 | U3 | U4 | U5 |
|-------|---|----|----|----|----|----|
| | A | | 62 | 60 | 53 | 54 |
| B | | 83 | 75 | 73 | 69 | 68 |

All Dimension are in mm

| LOWER | | L1 | L2 | L3 | L4 | L5 |
|-------|---|----|----|----|----|----|
| | A | | 63 | 61 | 57 | 60 |
| B | | 82 | 81 | 78 | 74 | 71 |

All Dimension are in mm

Perforated, Set of 10

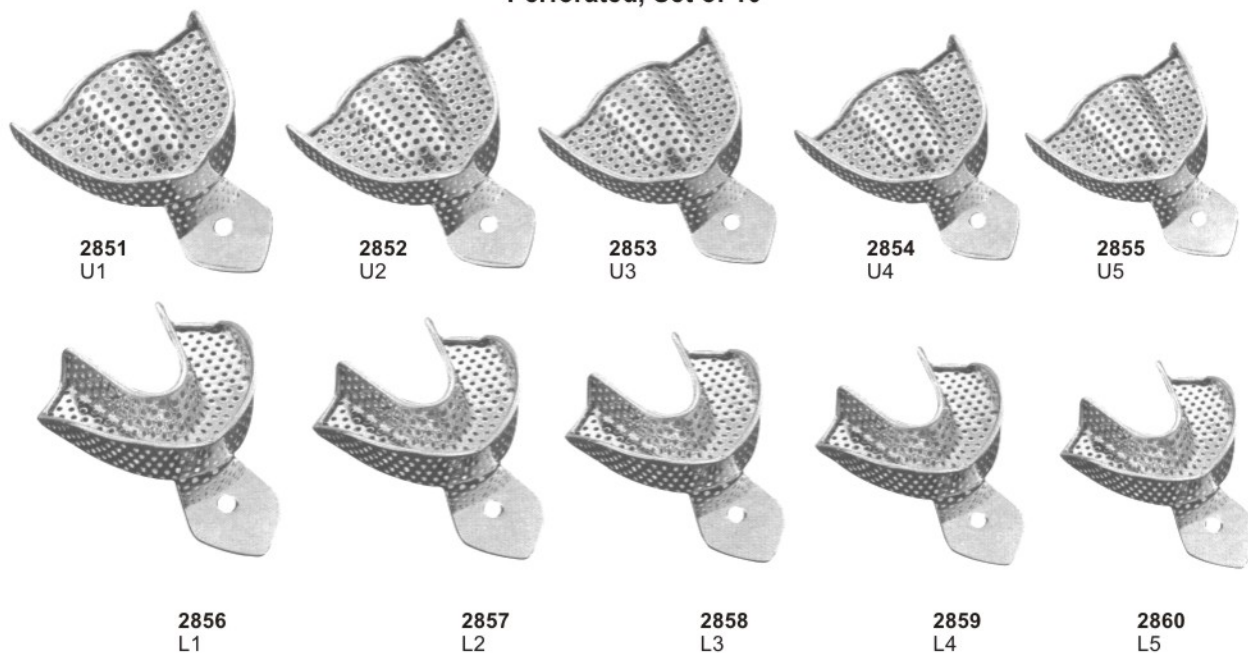

2851
U1

2852
U2

2853
U3

2854
U4

2855
U5

2856
L1

2857
L2

2858
L3

2859
L4

2860
L5

Impression Trays

Made of 18/8 Stainless Steel, Solid Full Denture Set of 8



2861
XL



2862
L



2863
M



2864
S



2865
XL



2866
L

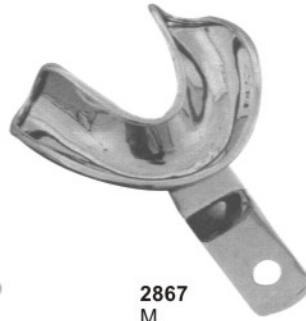

2867
M



2868
S

All The Above Impression Trays are Available in These 4 Sizes

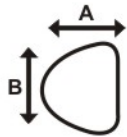

| UPPER | | XL | L | M | S |
|-------|----|----|----|----|----|
| | A | 70 | 67 | 64 | 60 |
| B | 79 | 76 | 70 | 73 | |

All Dimension are in mm

| LOWER | | XL | L | M | S |
|-------|----|----|----|----|----|
| | A | 64 | 64 | 60 | 57 |
| B | 86 | 70 | 73 | 70 | |

All Dimension are in mm

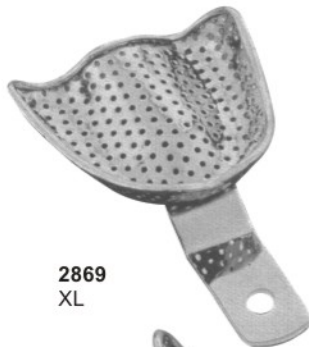

2869
XL

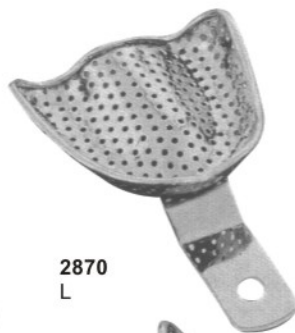

2870
L

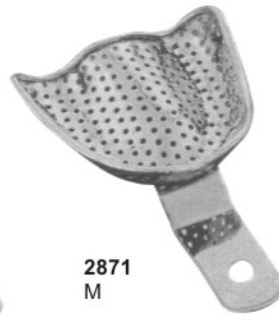

2871
M

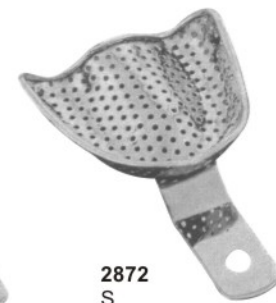

2872
S



2873
XL



2874
L



2875
M



2876
S

Perforated Full Denture Set of 8

Impression Trays

Made of 18/8 Stainless Steel, Solid Set of 6

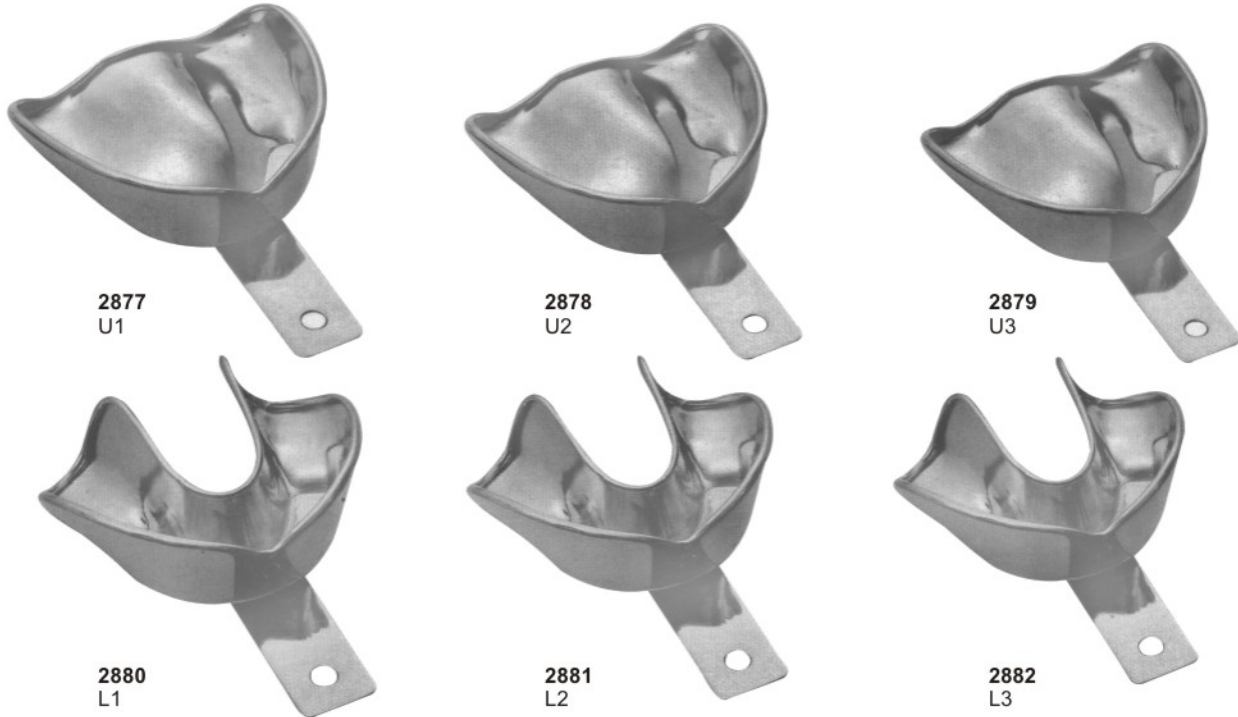

2877
U1

2878
U2

2879
U3

2880
L1

2881
L2

2882
L3

All The Above Impression Trays are Available in These 4 Sizes

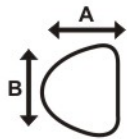

| UPPER | | U1 | U2 | U3 |
|-------|----|----|----|----|
| | A | 67 | 64 | 57 |
| B | 81 | 71 | 70 | |

All Dimension are in mm

| LOWER | | L1 | L2 | L3 |
|-------|----|----|----|----|
| | A | 60 | 57 | 54 |
| B | 81 | 79 | 76 | |

All Dimension are in mm

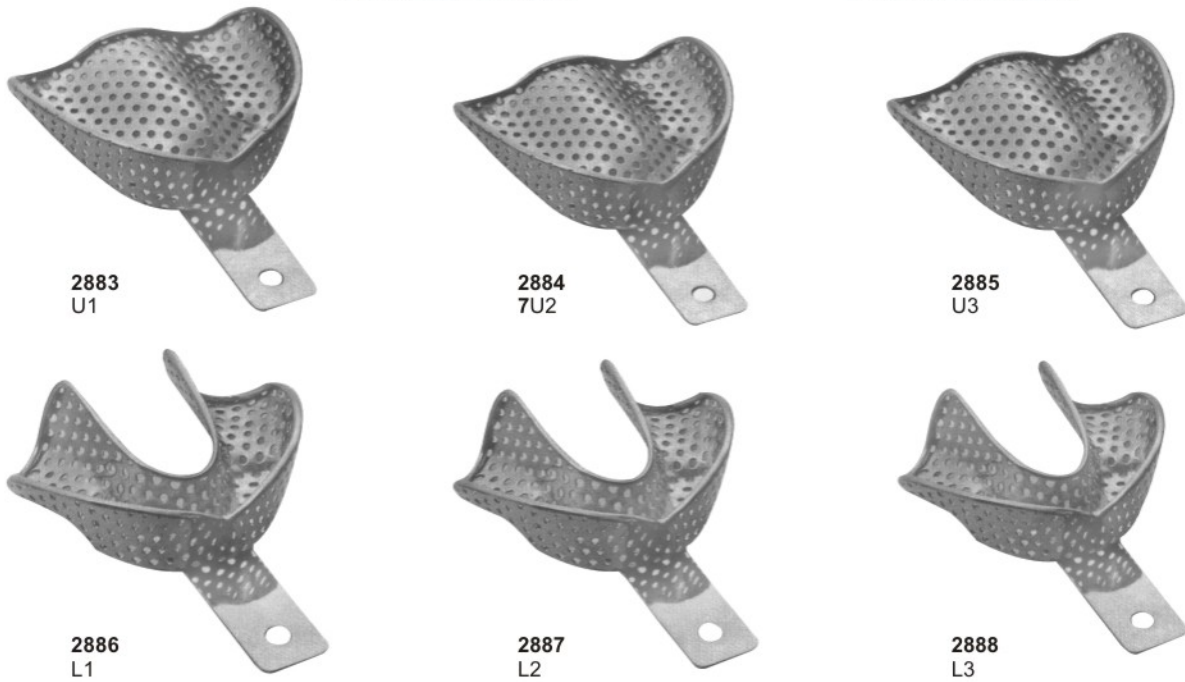
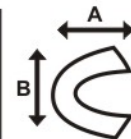

2883
U1

2884
U2

2885
U3

2886
L1

2887
L2

2888
L3

Perforated Set of 6

Impression Trays

Made of 18/8 Stainless Steel, English Pattern Set of 8

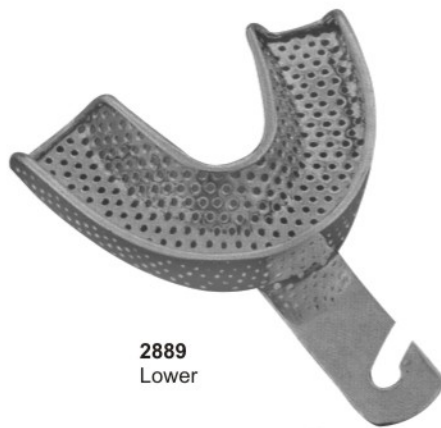

2889
Lower



2890
Upper

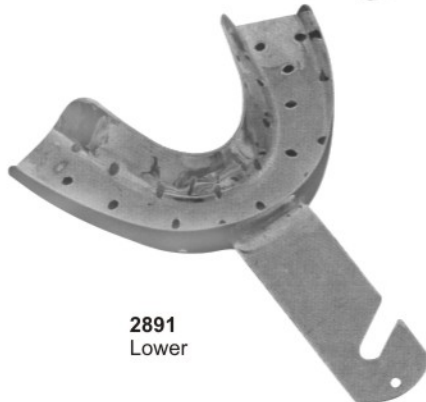

2891
Lower

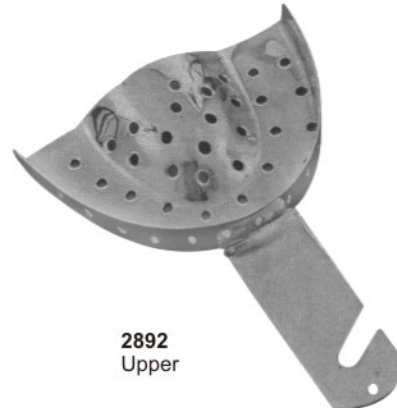

2892
Upper



2893
Lower



2894
Upper

All The Above Impression Trays are Available in These 4 Sizes

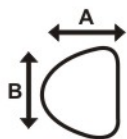

| UPPER | Size | A | B | C |
|-------|------|----|----|----|
| | 0 | 67 | 50 | 12 |
| | 1 | 72 | 51 | 13 |
| | 2 | 78 | 55 | 15 |
| | 3 | 80 | 58 | 15 |

All Dimension are in mm

| LOWER | Size | A | B | C |
|-------|------|----|----|----|
| | 0 | 70 | 50 | 14 |
| | 1 | 77 | 51 | 15 |
| | 2 | 79 | 55 | 15 |
| | 3 | 80 | 60 | 17 |

All Dimension are in mm

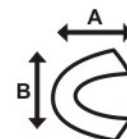

Impression Trays

Made of 18/8 Stainless Steel, Solid Full Denture Set of 8

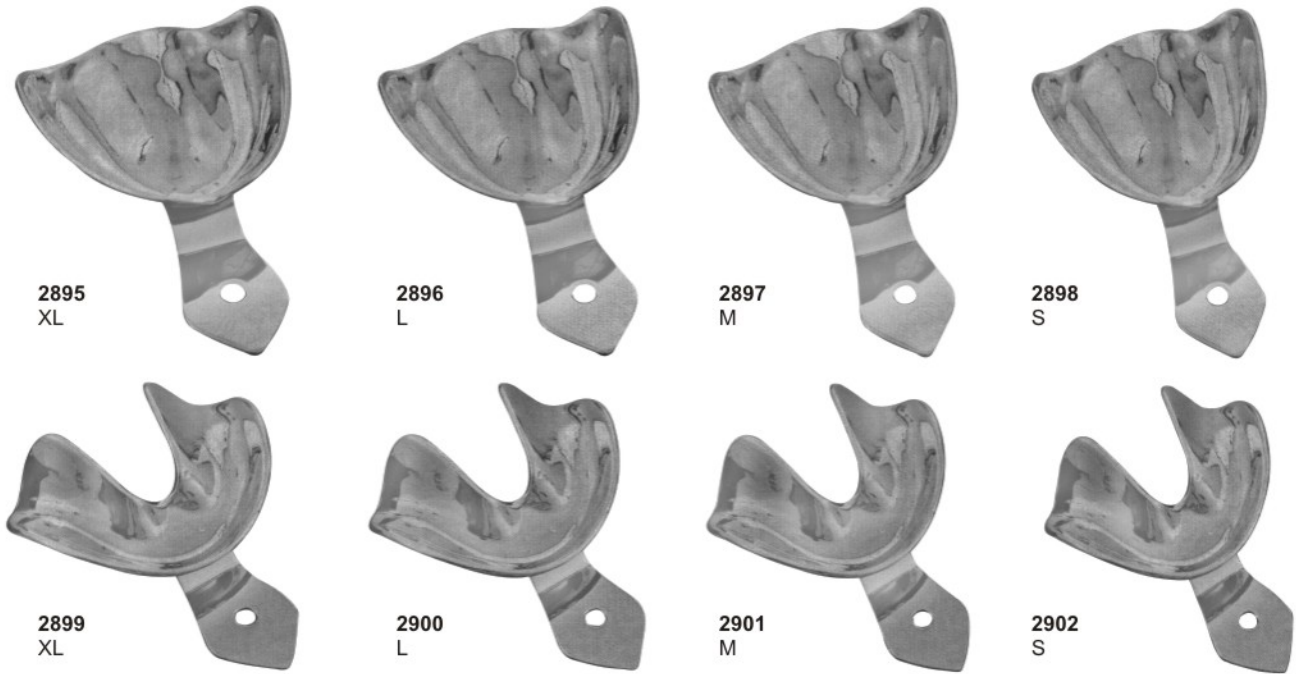

2895
XL

2896
L

2897
M

2898
S

2899
XL

2900
L

2901
M

2902
S

All The Above Impression Trays are Available in These 4 Sizes

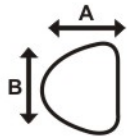

| UPPER | | XL | L | M | S |
|-------|----|----|----|----|----|
| | A | 70 | 67 | 64 | 60 |
| B | 79 | 76 | 70 | 73 | |

All Dimension are in mm

| LOWER | | XL | L | M | S |
|-------|----|----|----|----|----|
| | A | 64 | 64 | 60 | 57 |
| B | 86 | 70 | 73 | 70 | |

All Dimension are in mm

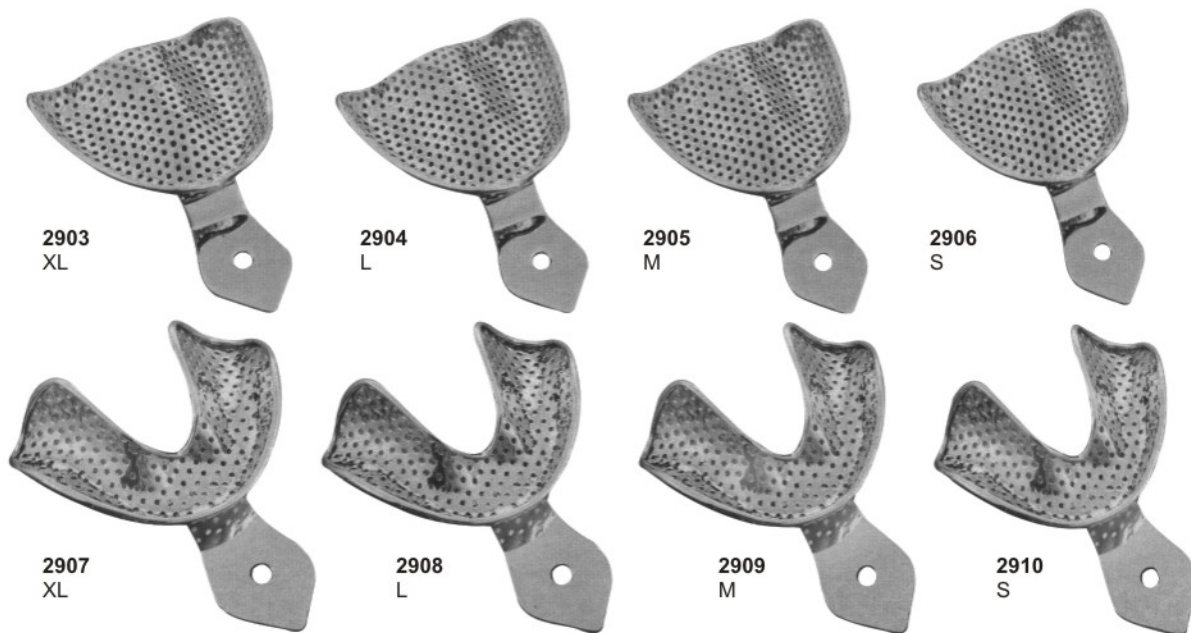

2903
XL

2904
L

2905
M

2906
S

2907
XL

2908
L

2909
M

2910
S

Made of 18/8 Stainless Steel, Perforated Full Denture Set of 8

Impression Trays

Made of 18/8 Stainless Steel, Solid Full Denture Set of 8

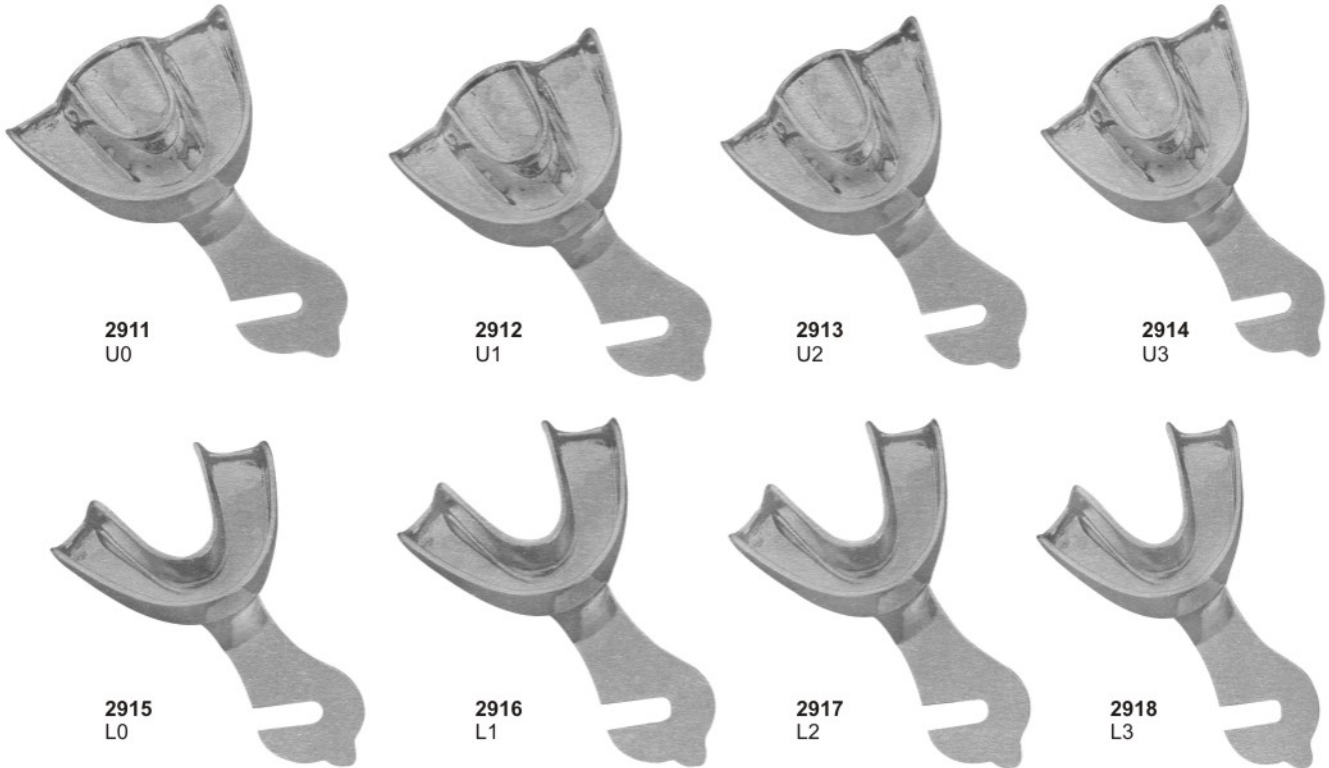

Upper Sizes: 0,1,2,3

Depth of Tray: 15,9 mm, Height of Plate: 12,5 mm

Lower Sizes: 0,1,2,3

Depth of Tray: 12,9 mm

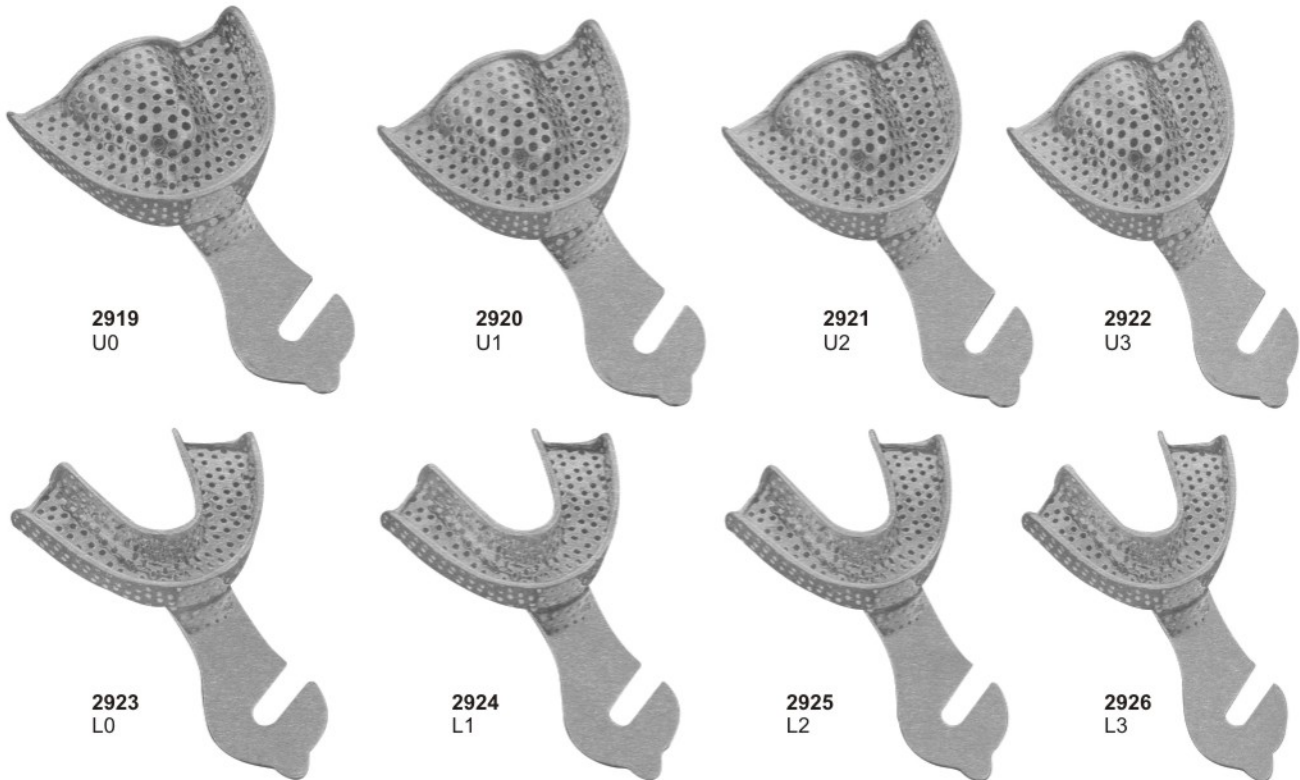

Made of 18/8 Stainless Steel, Perforated Full Denture Set of 8

Impression Trays

Impression Trays For Crown & Bridge Work

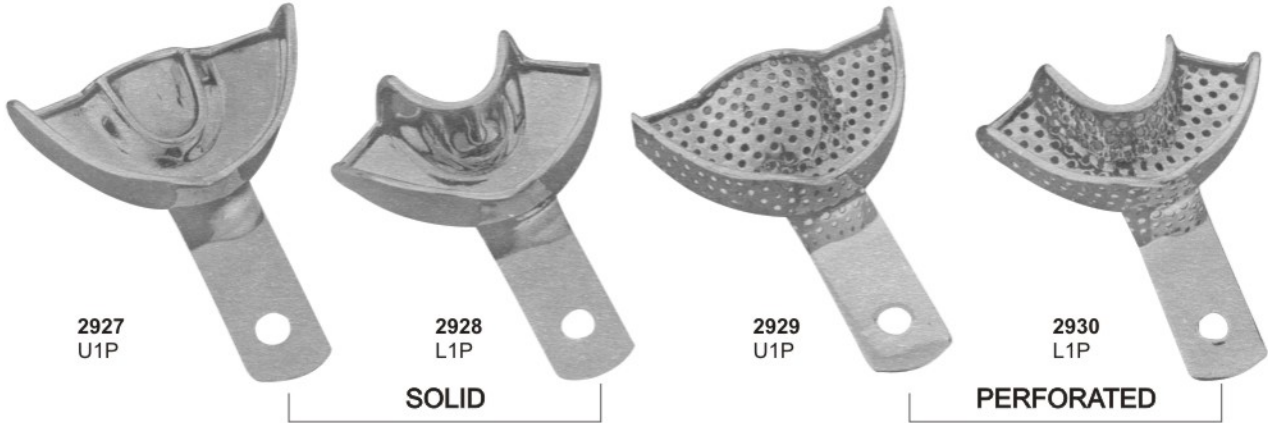

2927
U1P

2928
L1P

2929
U1P

2930
L1P

SOLID

PERFORATED



2932
Adjustable
Perforated



2933
Adjustable
Solid

PERFORATED

SOLID



2931-A
For upper right jaw
For lower left jaw

2931-B
For upper left jaw
For lower right jaw



2931-C
For upper right jaw
For lower left jaw

2931-D
For upper left jaw
For lower right jaw

Available in 4 sizes

- 1.....44 mm
- 2.....55 mm
- 3.....60 mm
- 4.....65 mm

Available in 4 sizes

- 1.....44 mm
- 2.....55 mm
- 3.....60 mm
- 4.....65 mm



2934



2935



2936



2937

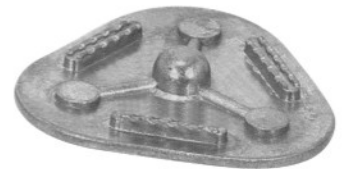

2939



2938

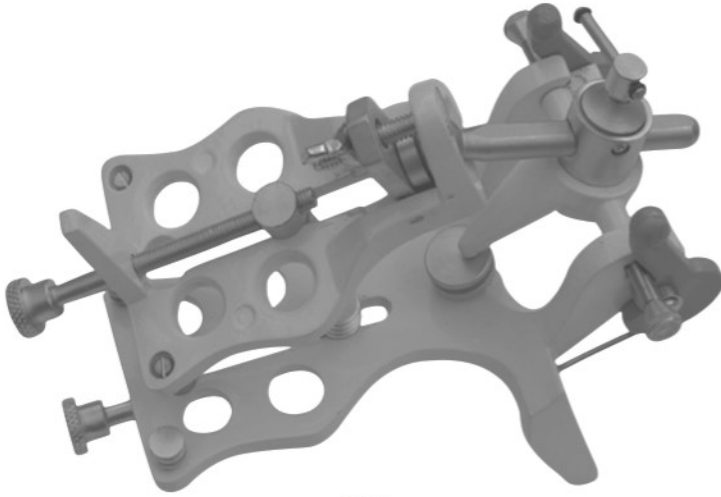

2940



2941



2942



2943



2944



2945



2946



2947

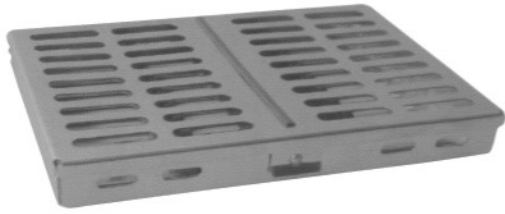

2948
Instruments Tray of 20 Pcs

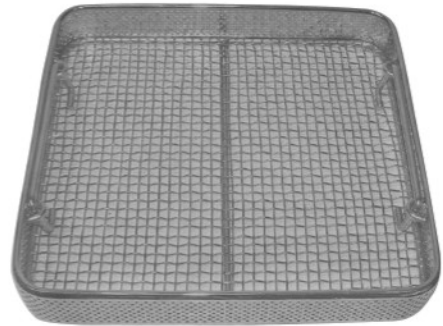

2951
Instruments Riddle



2949
Instruments Tray of 7 Pcs

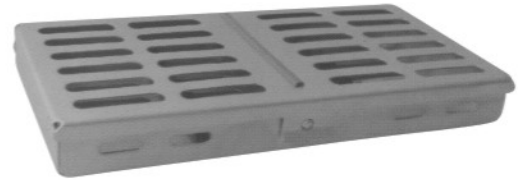

2949-A
Instruments Tray of 10 Pcs



2950
Instruments Tray of 5 Pcs

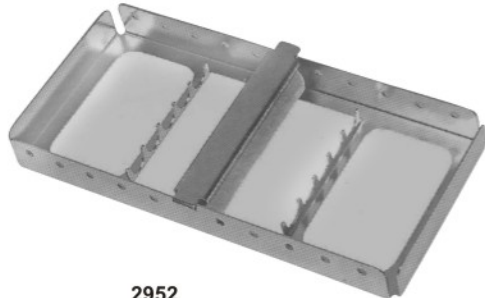

2952
Instruments Tray of 5 Pcs

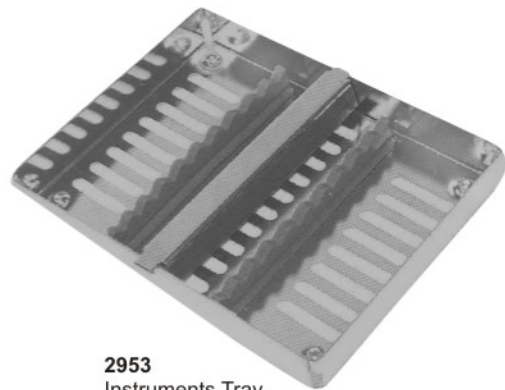

2953
Instruments Tray



2954
Instruments Tray
Perforated



2955
Instruments Tray
Perforated Base



2956
Instruments Tray
Solid Base



2957
Pulpectomy Tray



2958
Sterilizing Box
Available Sizes:
17x17x3 cm
20x10x6 cm
30x14x6 cm



2959
Endo Tray Box



2960
Finger Cup



2961
Bur Box

2962
Sterilizing Drum
150x150mm
175x175mm
190x190mm
200x140mm
200x200mm
240x120mm
225x225mm
240x240mm
290x160mm



2963
Sterilizing Drum
280x240mm
230x150mm
300x250mm
340x160mm
350x250mm
390x200mm
380x300mm
100x100mm
150x120mm

Sterilizing Boxes & Instruments Trays



2964
Instruments Box



2965
Instruments Box



2966
Instruments Box



2967
Instruments Sterilizer
150x75 mm



2968
Endodontic Box



2969
Sterilizing Box
320x120 mm



2970
Instruments Tray



2971
Instruments Tray



2972
Instruments Tray
(Perforated)



2973
Instruments Tray
Shallow(Mayo)



2974
Scaler Tray
20.0 x 10.0 x 1.5 cm

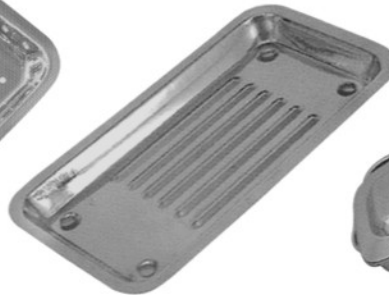

2975
Scalers Tray



2976
Scalers Tray

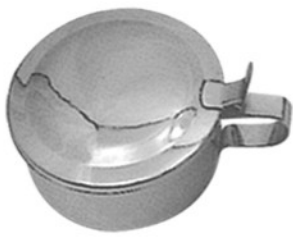

2982
Spitten Mug



2983
Spirit Burner With Wick
Stainless Steel 18/10
Capacity: 150 ml, 60 ml



2984
Spirit Burners With Wick
Stainless Steel 18/10
Capacity: 70ml



2985
Dressing Jar



2986
Dressing Jar



2987
Irrigator (Douch Can)



2988
Measuring Jug

Hollow Wares



2989
Sponge Bowl



2990
Wash Basin
300mm-350mm-400mm



2994
Kick Bucket With Trolley



2991
Sponge Bowl



2992
Gallipot



2993
Medicine Cup



2995
Kidney Tray Shallow
150mm-200mm-240mm-300mm



2996
Kidney Tray Without Lid
150mm-200mm-250mm-300mm



2997
Kidney Tray With Lid
150mm-200mm-250mm-300mm

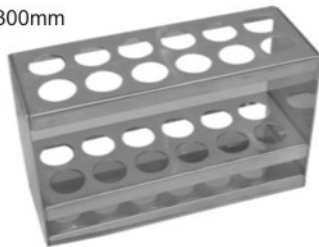

2998
Tube Rack, Stainless Steel 18/10

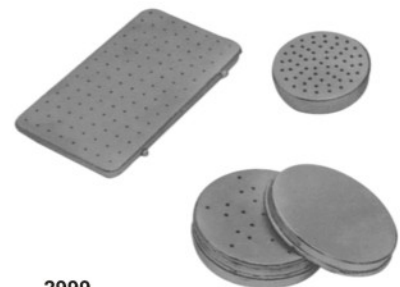

2999
Needle Case Rectangle
Needle Case Round With Cover
90x15



3000
Dustbin Without Stand
6-10-12 Ltr



3001
Tube Rack, Round Model
Stainless Steel 18/10



3002
Dustbin Without Stand & Cap
6-10-12 Ltr

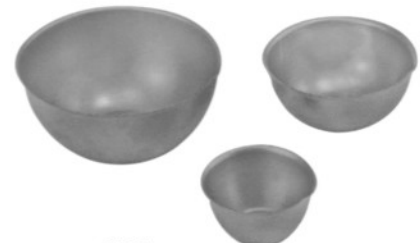

3003
Lotion Bowl With Lip
40-60-80-100-120-150-180-200mm

Scissors With Tungsten Carbide Inserts



3004
Standard

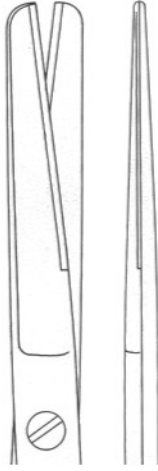

14,5cm
16,5cm
18,5cm



3005
Standard

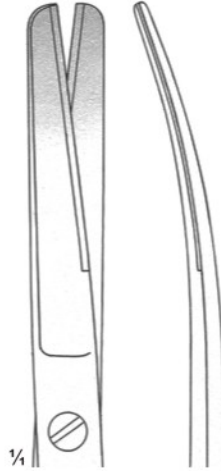

14,5cm
16,5cm
18,5cm



3006
Standard

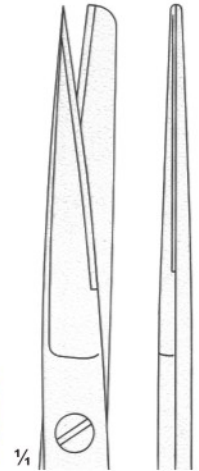

14,5cm
16,5cm
18,5cm



3007
Standard

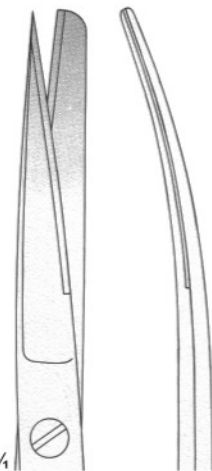

14,5cm
16,5cm
18,5cm



3008
Standard

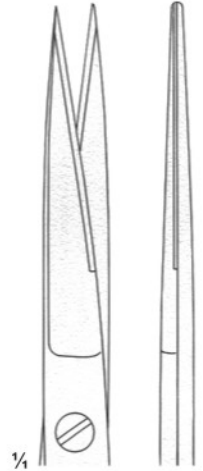

14,5cm
16,5cm
18,5cm



3009
Standard

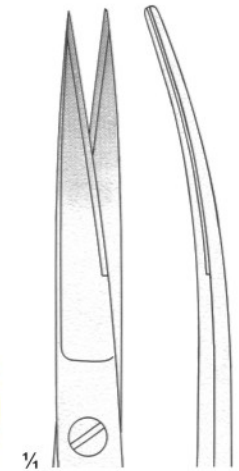

14,5cm
16,5cm
18,5cm

Scissors With Tungsten Carbide Inserts

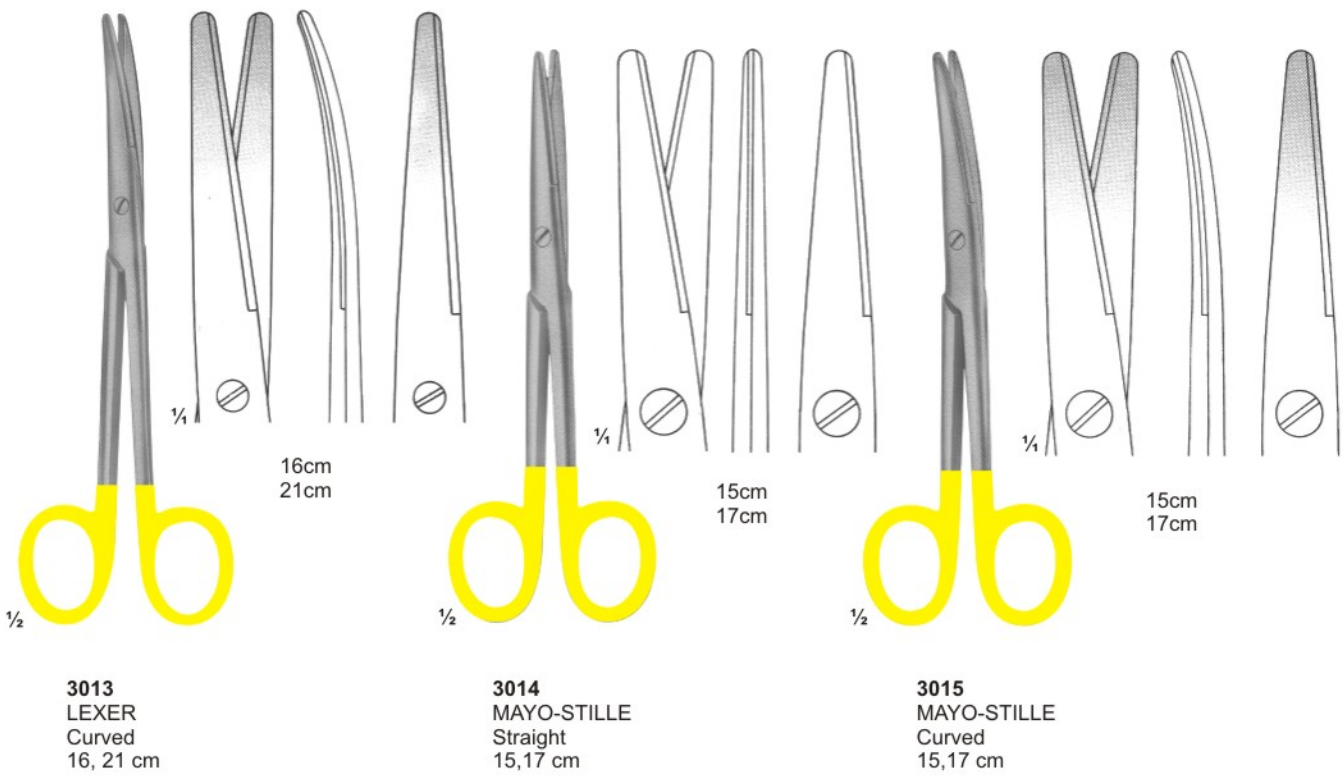
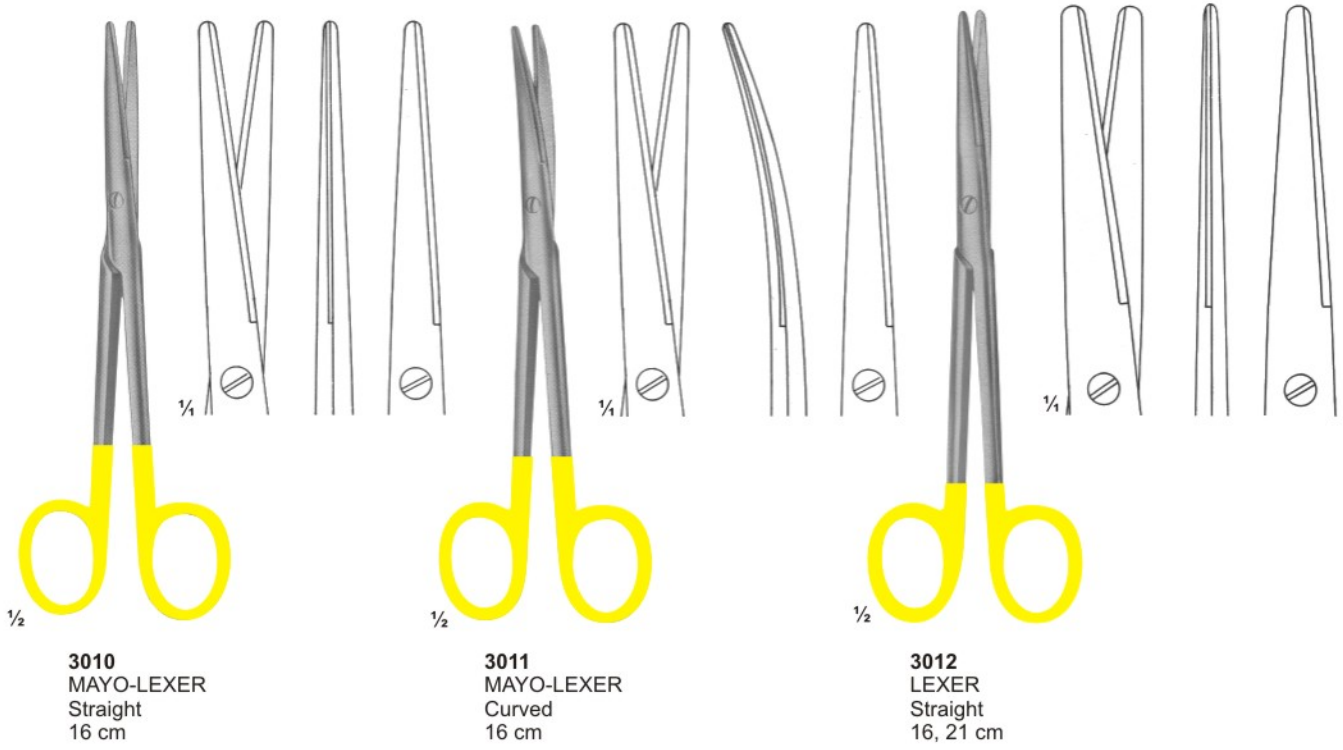

Scissors With Tungsten Carbide Inserts

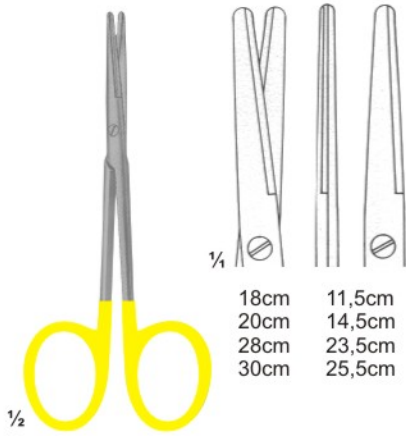

18cm 11,5cm
20cm 14,5cm
28cm 23,5cm
30cm 25,5cm

3016
METZENBAUM
Straight

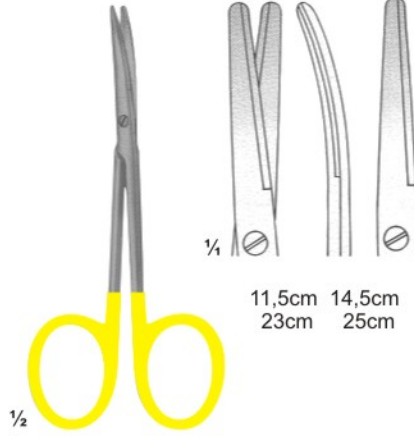

11,5cm 14,5cm
23cm 25cm

3017
METZENBAUM
Curved

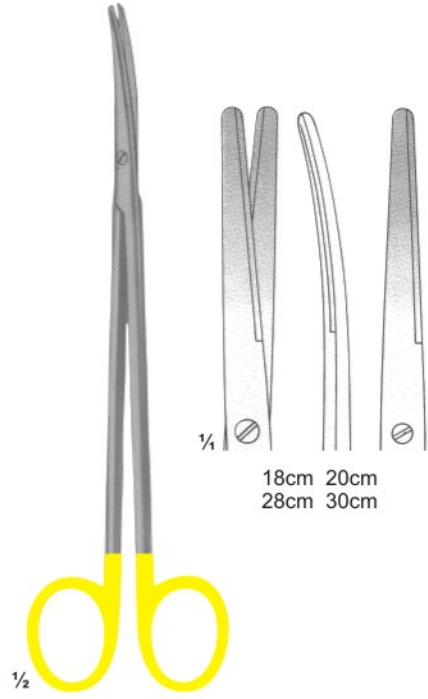

18cm 20cm
28cm 30cm

3018
METZENBAUM
Curved



14cm 18cm 20cm
23cm 25cm 28cm

3019
METZENBAUM FINO
Straight



14cm 18cm 20cm
23cm 25cm 28cm

3020
METZENBAUM FINO
Curved

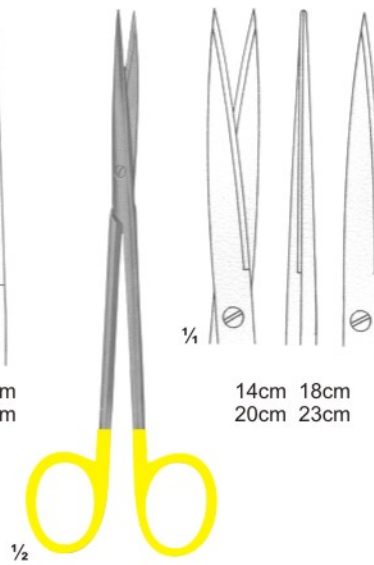

14cm 18cm
20cm 23cm

3021
METZENBAUM FINO
Sharp

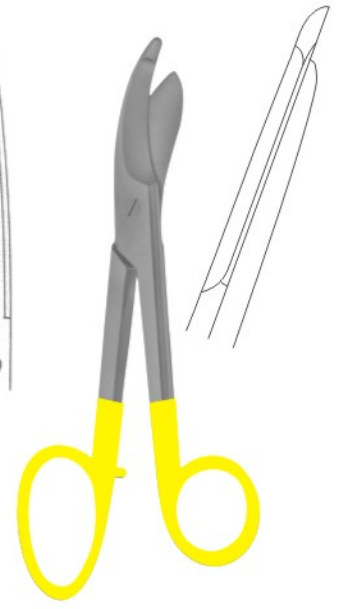

3022
BRUNS
235 mm

Scissors With Tungsten Carbide Inserts

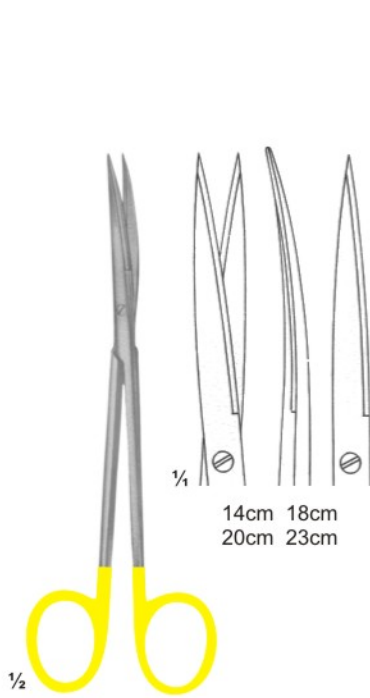

3023
METZENBAUM FINO

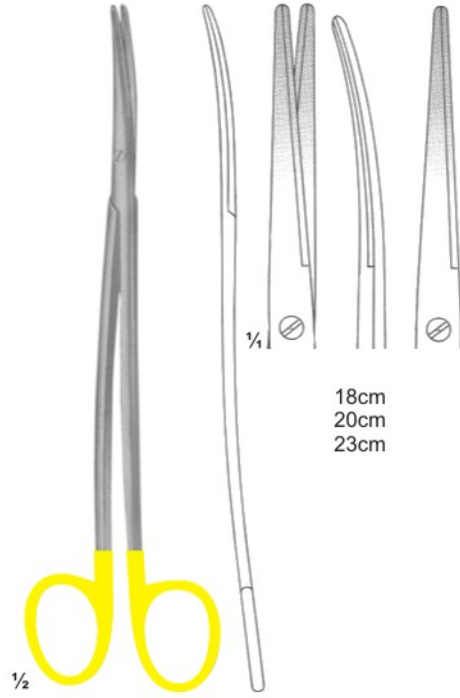

3024
METZENBAUM FINO

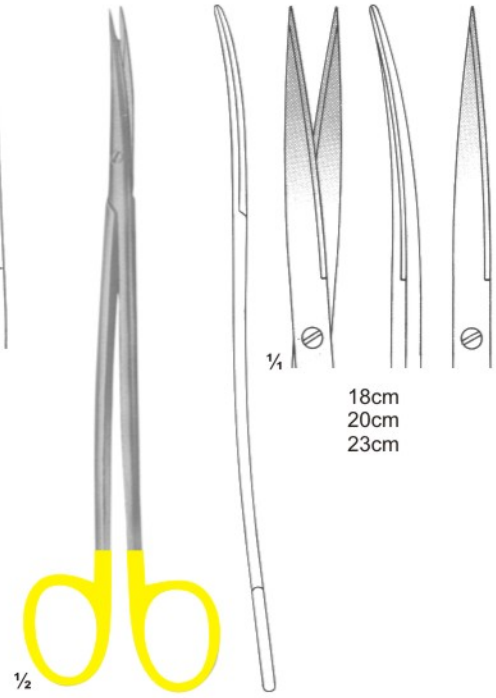

3025
METZENBAUM FINO

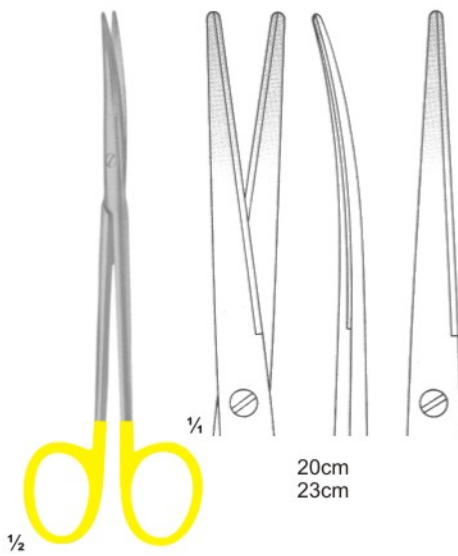

3026
METZENBAUM FINO

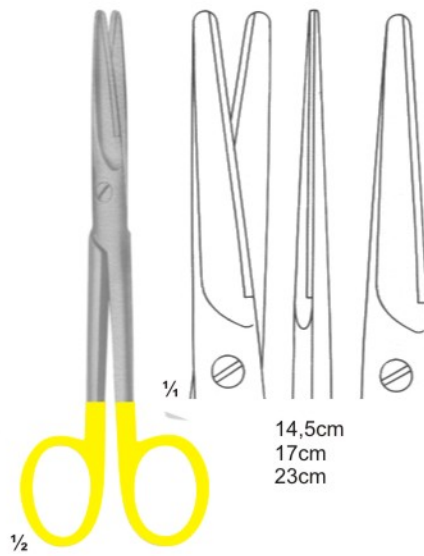

3027
MAYO
Straight

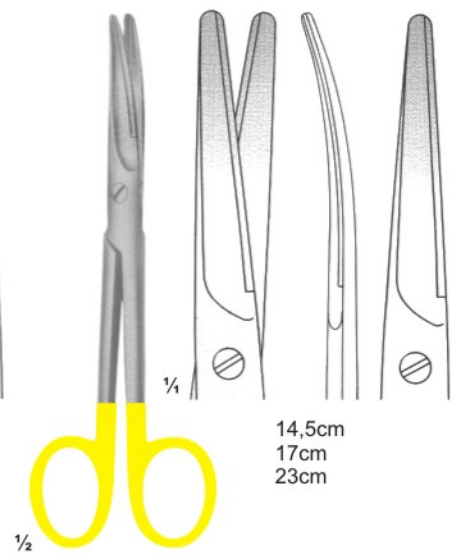

3028
MAYO
Curved

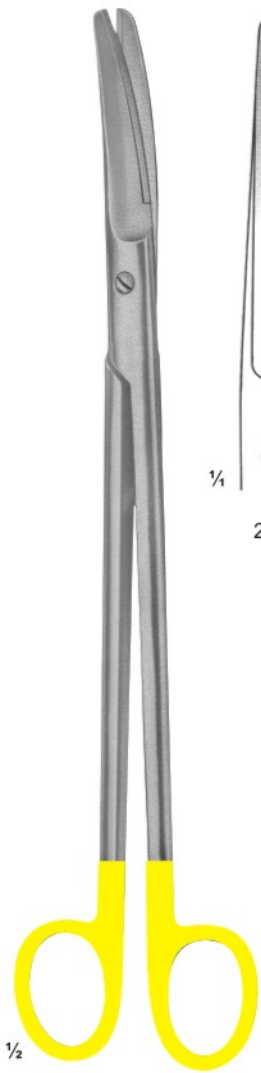

**3029
SIMS**

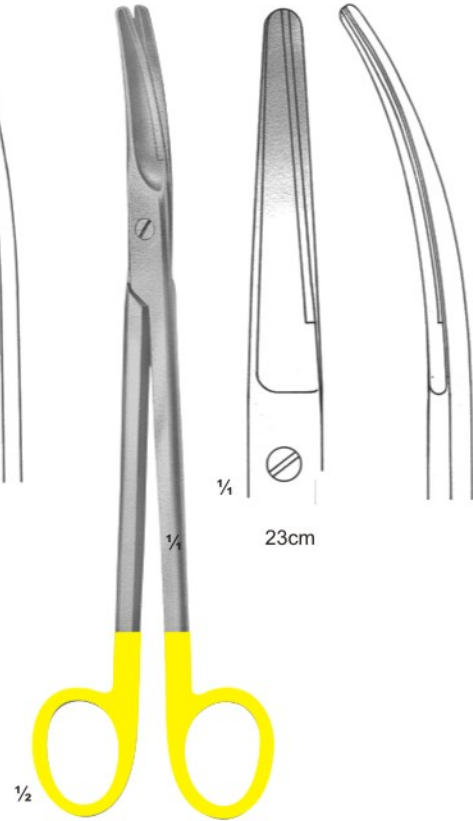
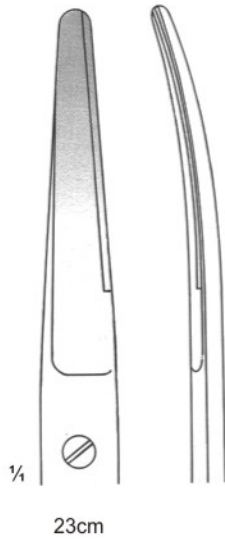

**3030
PARAMETRIUM**

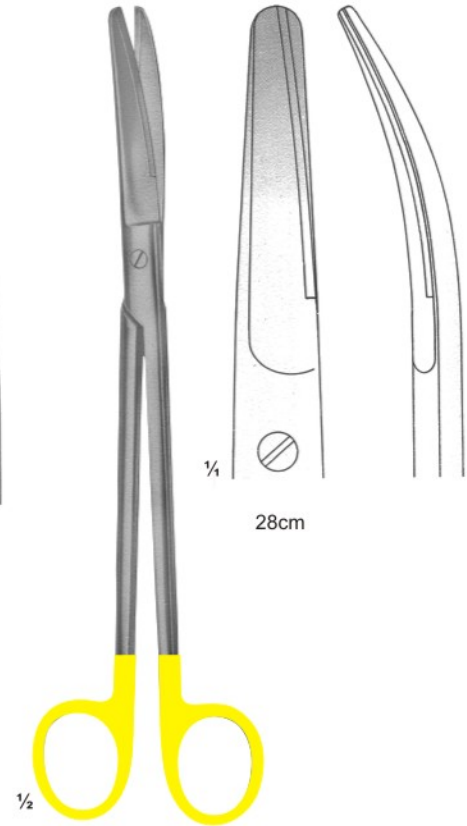
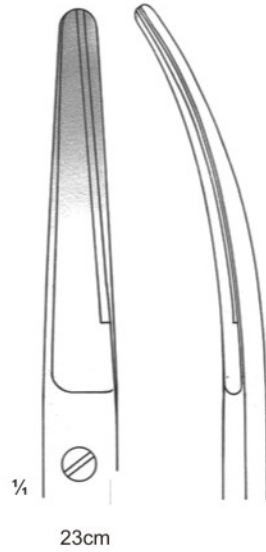

**3031
MAYO-HARRINGTON**

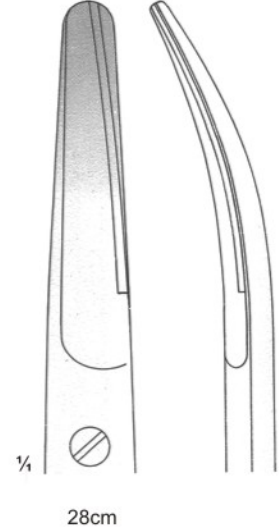

**3032
KELLY
Straight 16 cm**



**3033
KELLY
Curved 16 cm**



**3034
DEAN
17 cm**



**3035
LAGRANGE
Double-Curved
11.5 cm**

Scissors With Tungsten Carbide Inserts



3036
DE-BAKEY



3037
DE-BAKEY

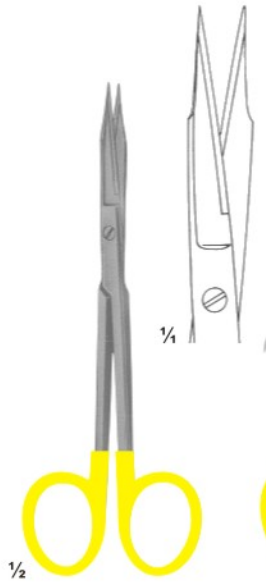

3038
GOLDMAN FOX
13 cm



3039
GOLDMAN FOX
Double-Curved
13 cm

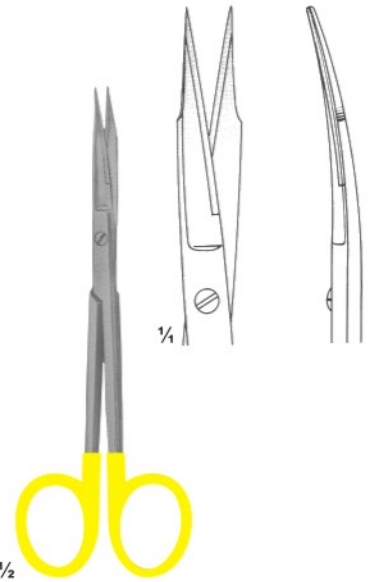

3040
GOLDMAN FOX
13 cm

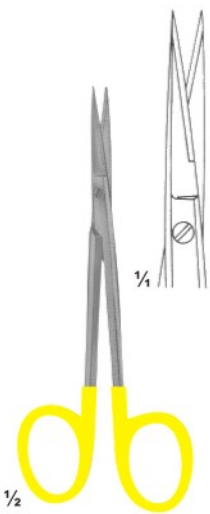

3041
Fine Scissors
Straight
11, 5 cm

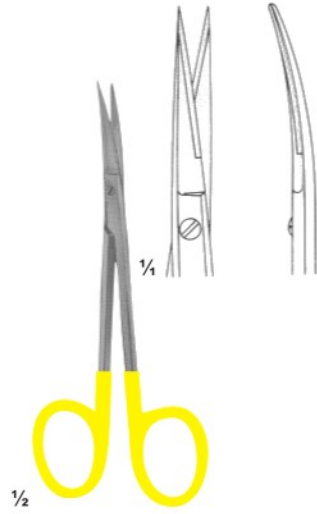

3042
Fine Scissors
Curved
11, 5 cm

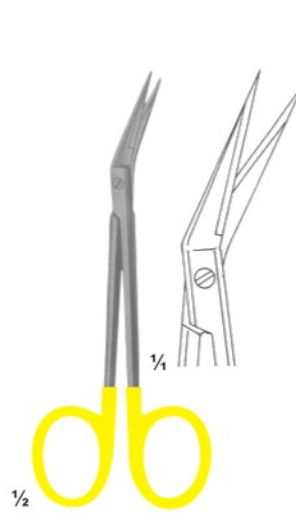

3043
Fine Scissors
Angled
11, 5 cm

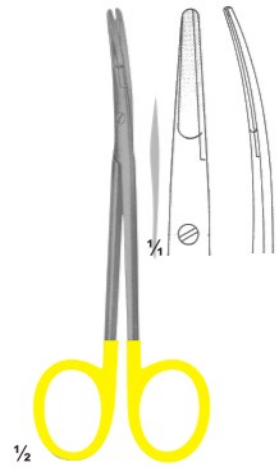

3044
RAGNELL
Curved
12 cm

**Scissors & Dissecting Forceps
With Tungsten Carbide Inserts**

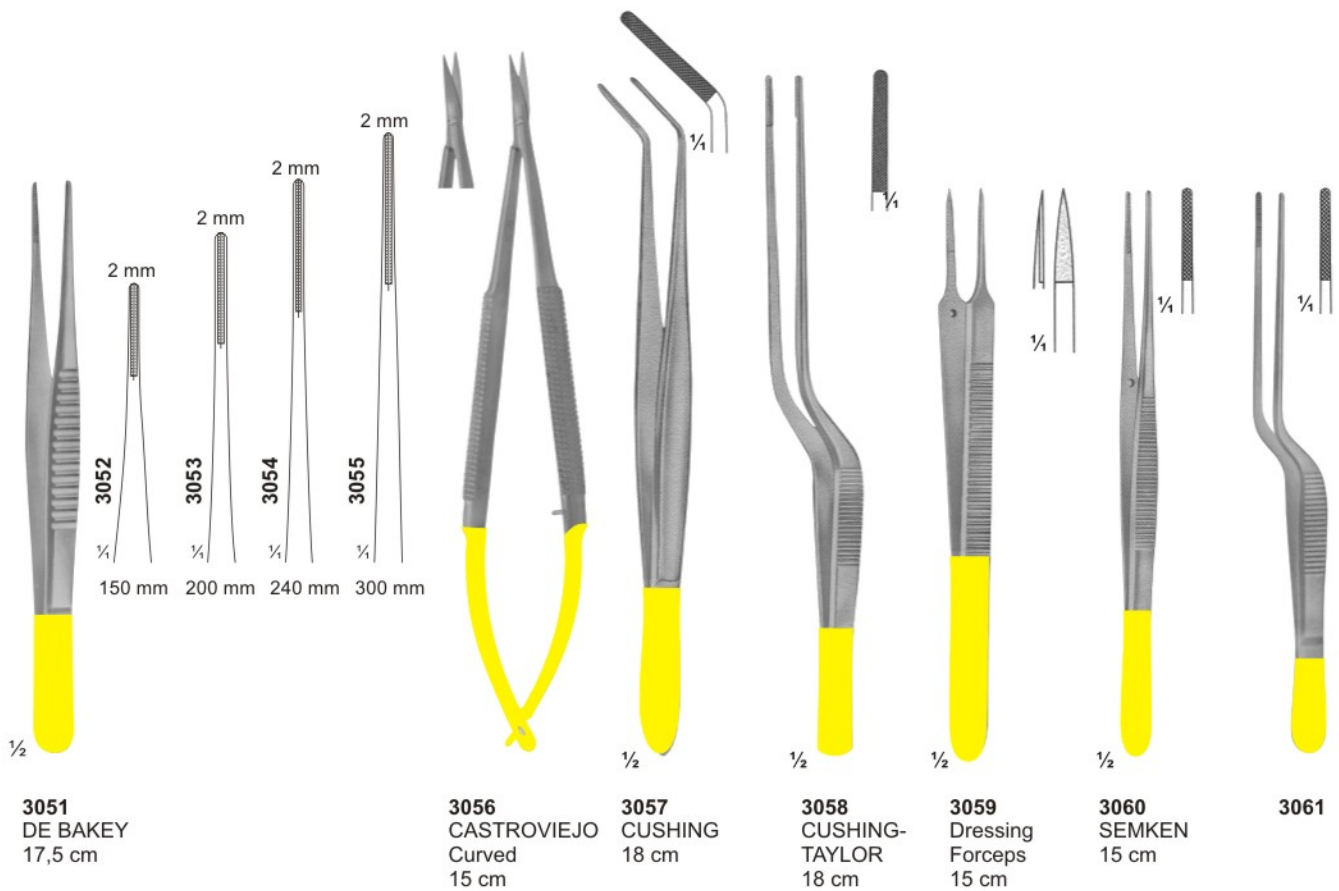
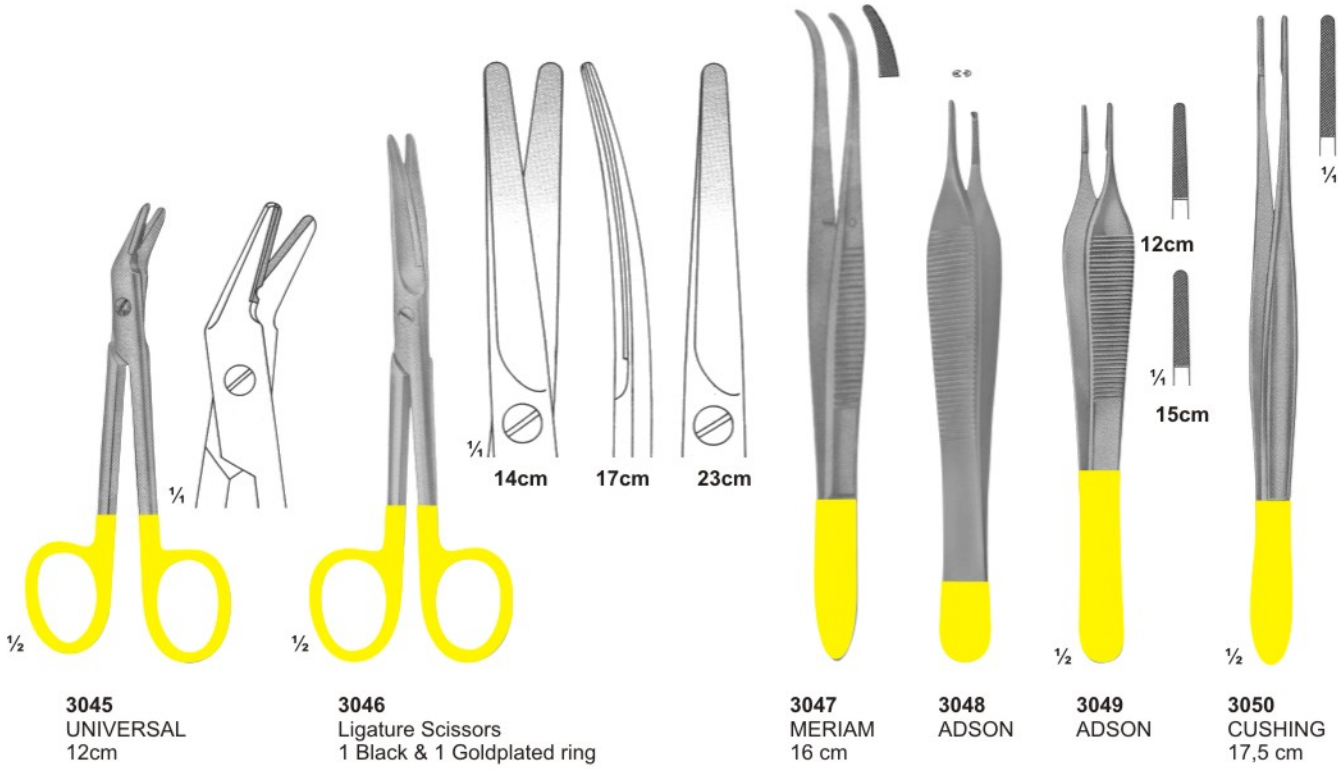

**Dissecting Forceps & Needle
Holders T.C Instruments**

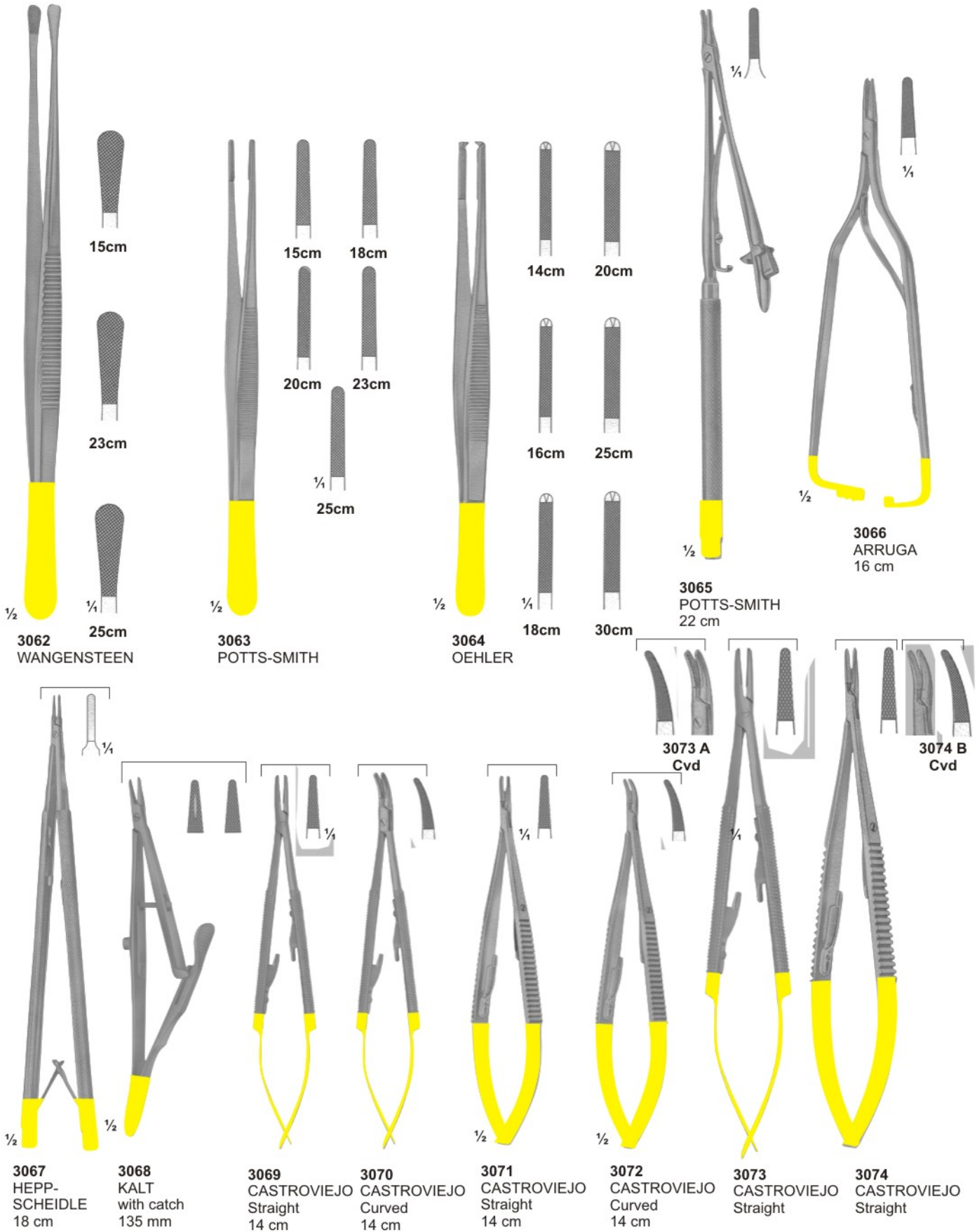

Needle Holders With T.C. Inserts

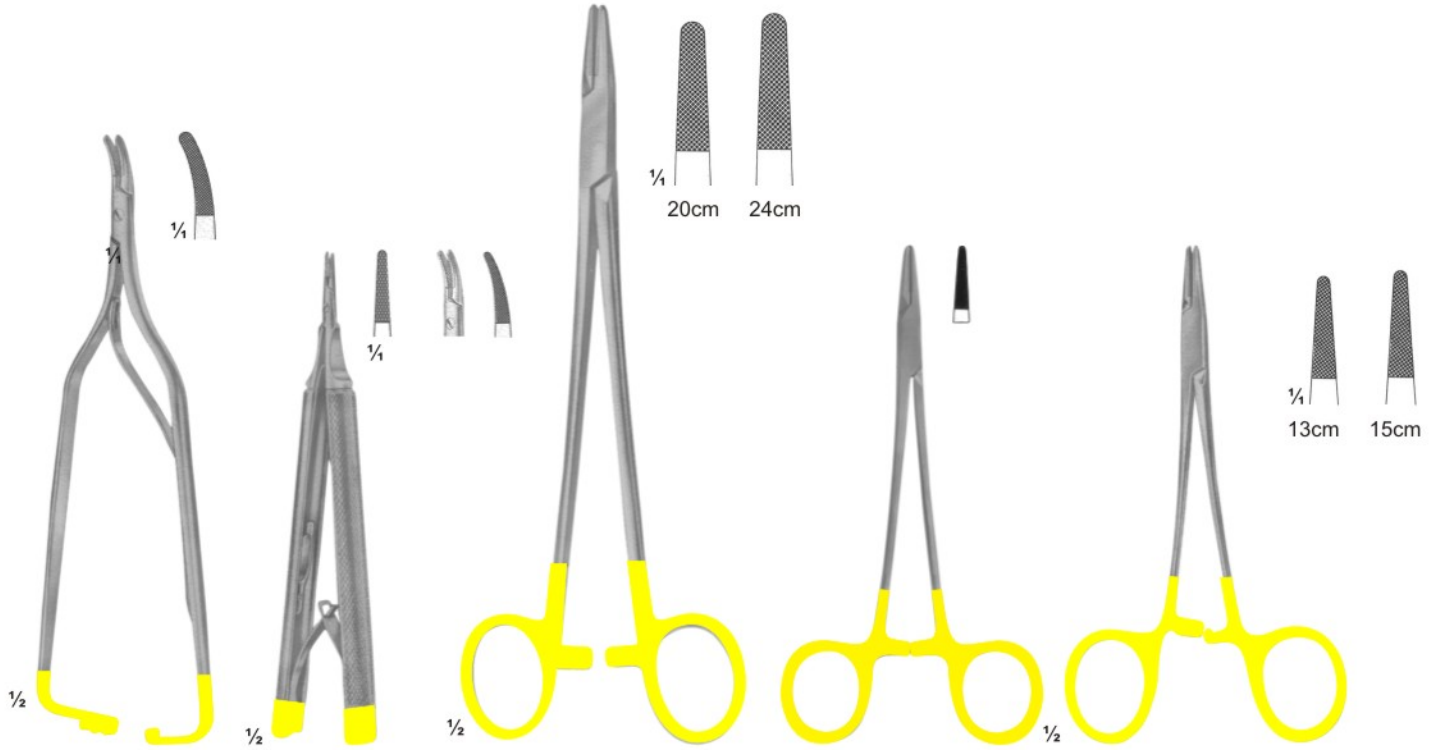

3075
ARRUGA
Curved
16 cm

3076
CASTROVIEJO
13 cm

3077
HEGAR
20,24 cm

3078
SMOOTH TIP
15 cm

3079
HALSEY
13,15 cm

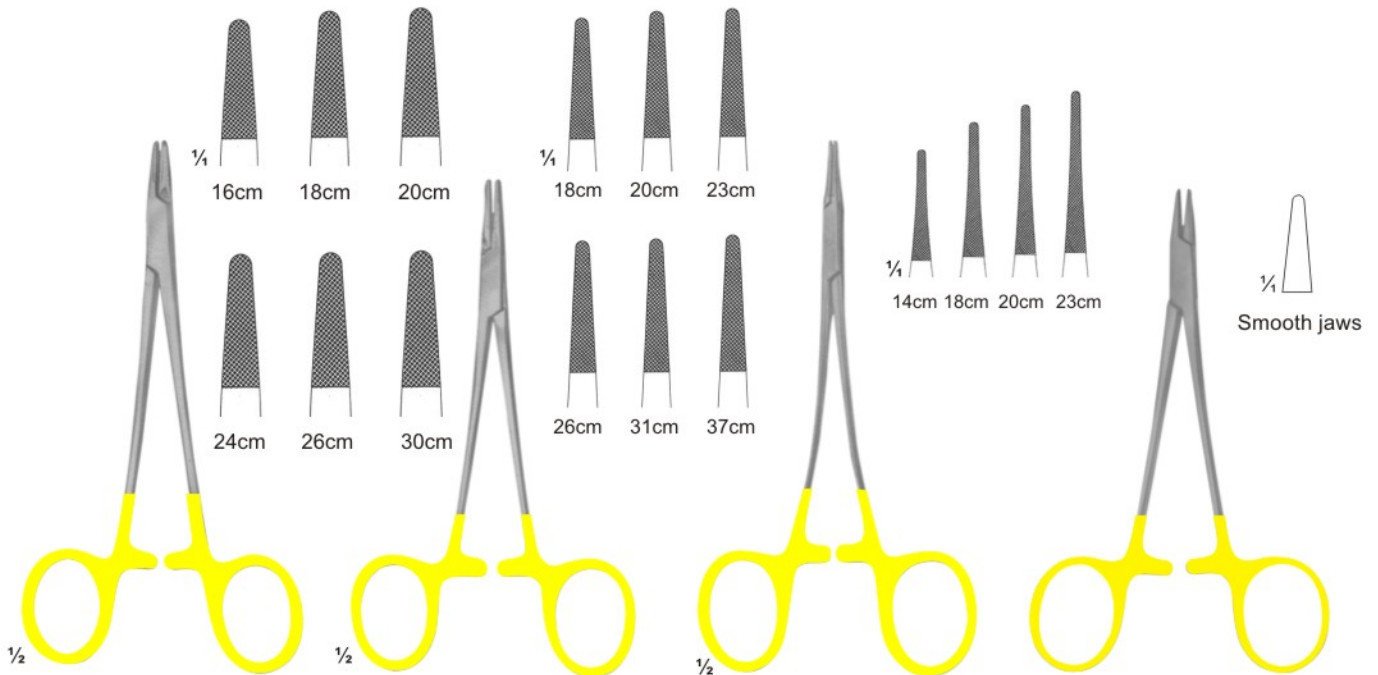

3080
MAYO-HEGAR

3081
DE BAKEY

3082
HEGAR-VASCULAR

3083
WEBSTER
125 mm

**Needle Holders With
Tungsten Carbide Inserts**

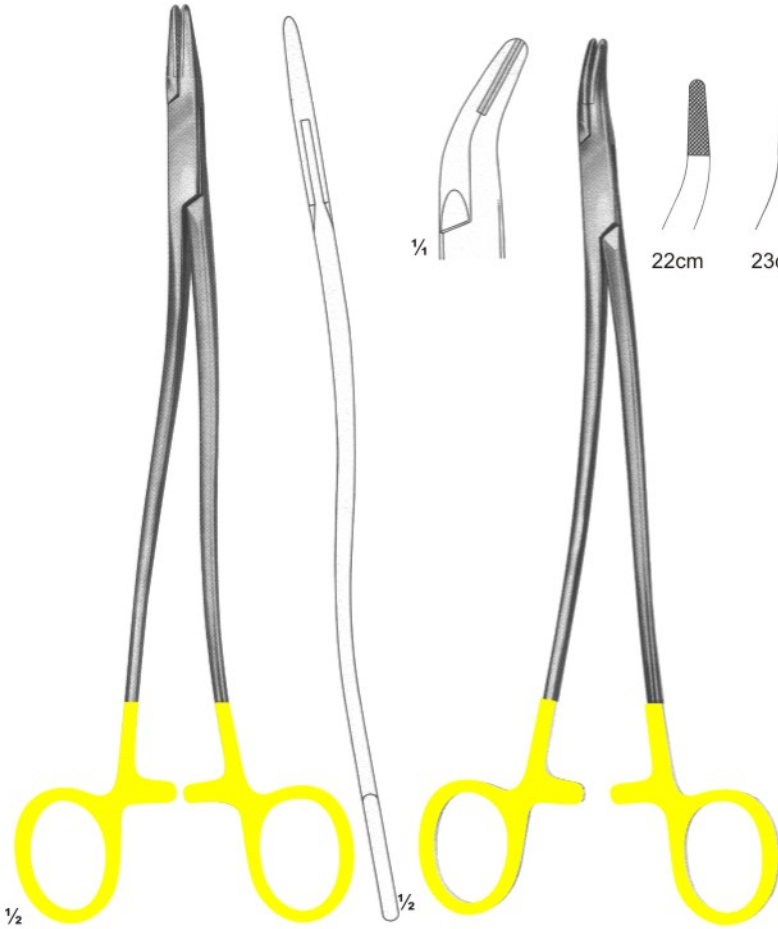

3084
BOZEMANN-WERTHEIM
20, 24, 26 cm

3085
STRATTE

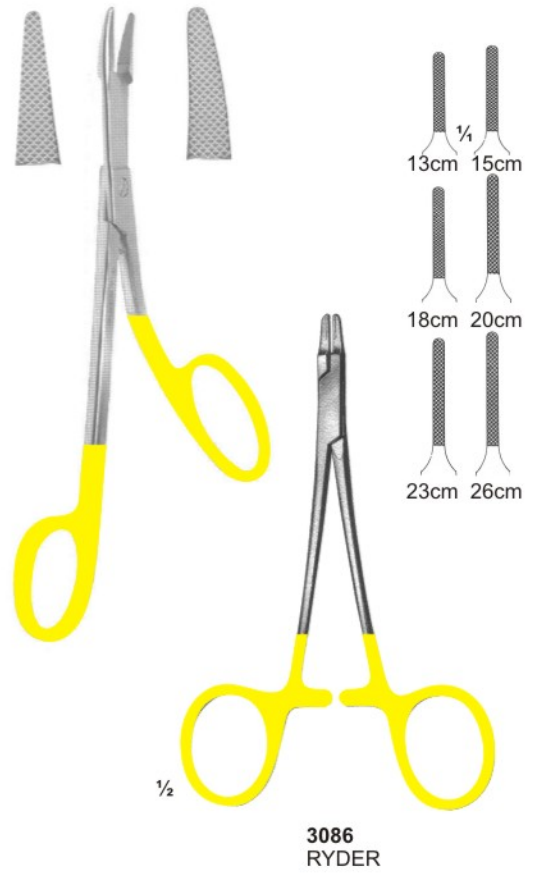

3086
RYDER



3087
RYDER-VASCULAR

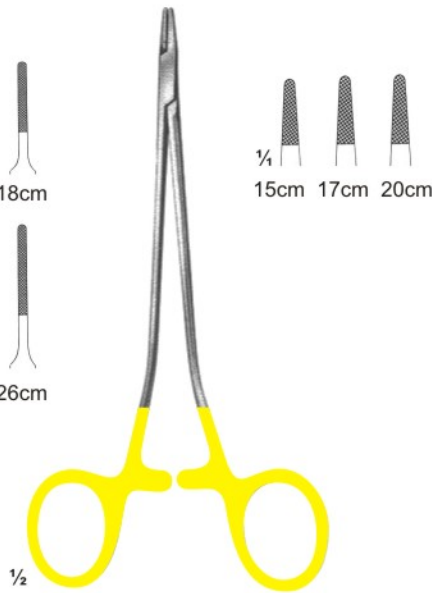

3088
MARTIN

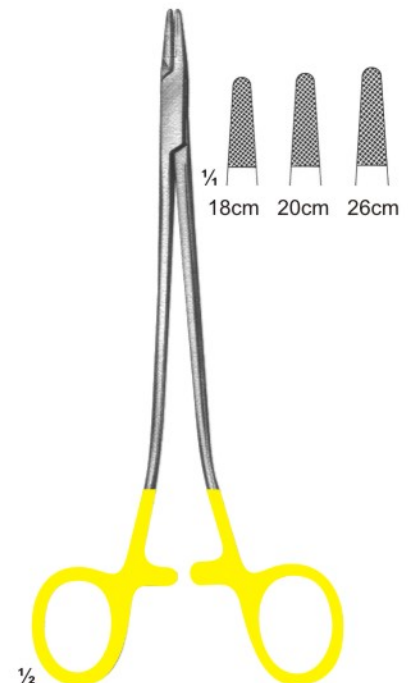

3089
SAROT

Needle Holders With Tungsten Carbide Inserts

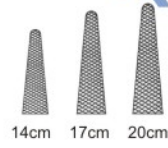

3090
FINOCHIETTO
27 cm

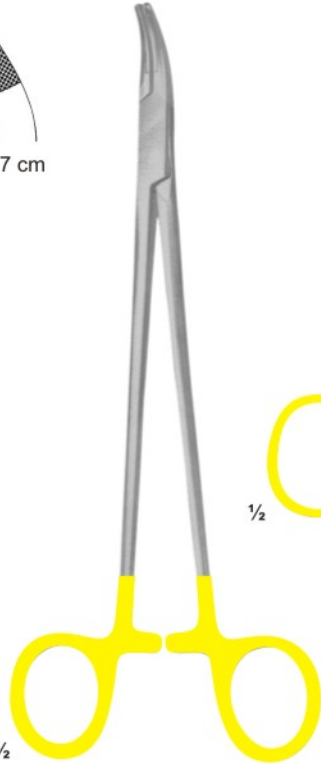

3091
HEANEY
27,24 cm

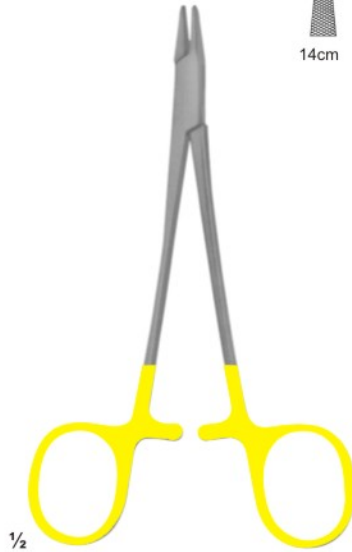

3092
BAUMGARTNER
145 mm

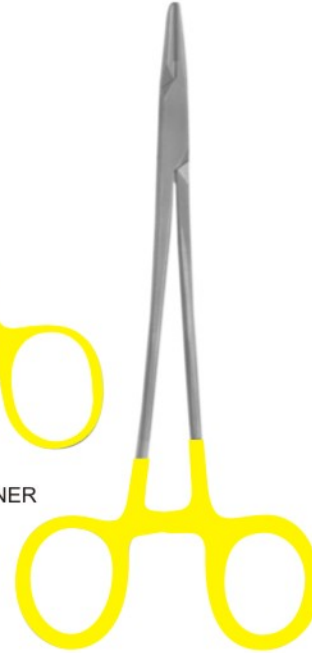

3093
CRILE-WOOD
15 cm



3094
MATHIEU



3095
MATHIEU
14,17,20 cm



3096
MATHIEU-KOSHER
14,17,20,24 cm



3097
MATHIEU-KOSHER
17,20,24 cm



3098
MATHIEU-VASCULAR
17,20,24 cm



3099
MATHIEU-VASCULAR
Hosel
17,20 cm

Needle Holders With T.C. Inserts

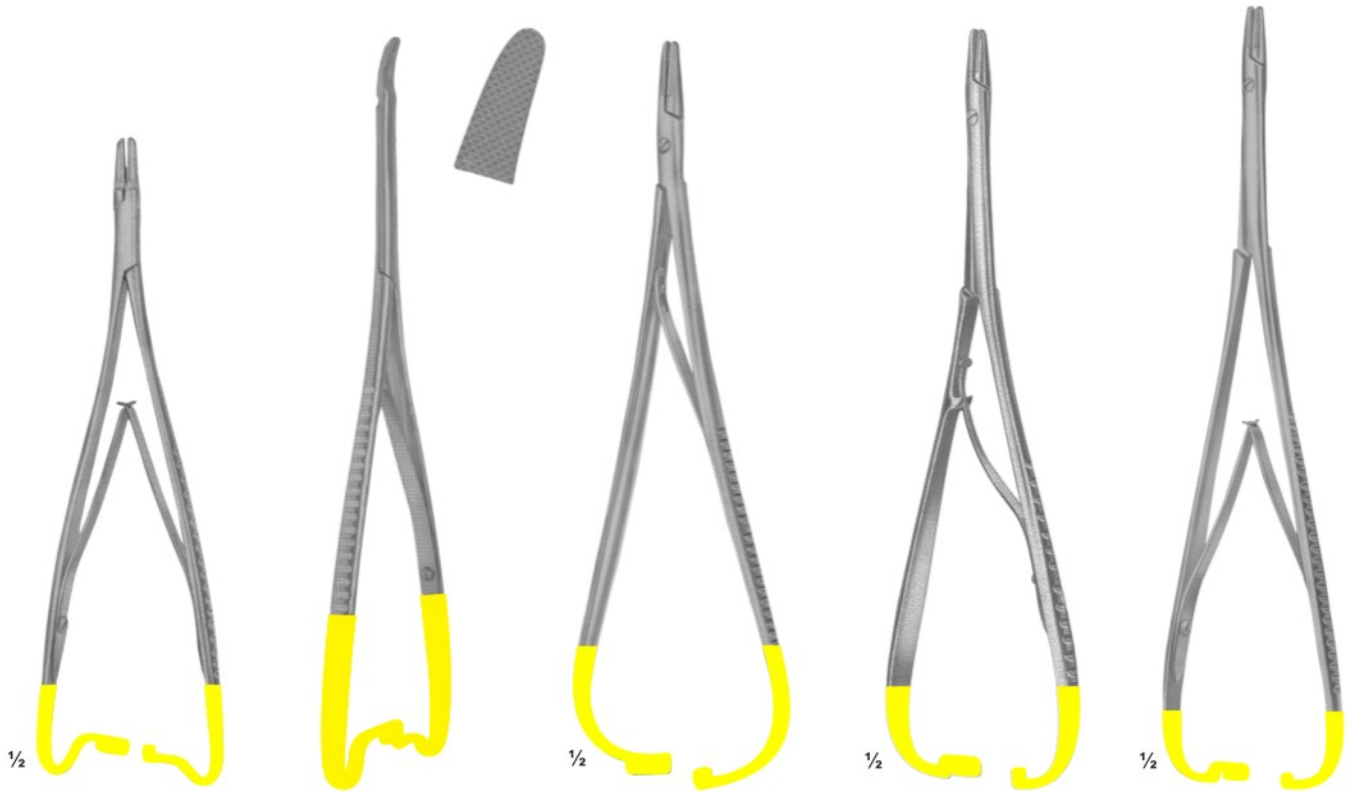

1/2
3100
MATHIEU-RYDER
17,20,24 cm

3101
Hosel
Curved
20 cm

1/2
3102
LICHTENBERG
20 cm

1/2
3103
LANGHALS
20,25 cm

1/2
3104
LICHTENBERG
20,25 cm

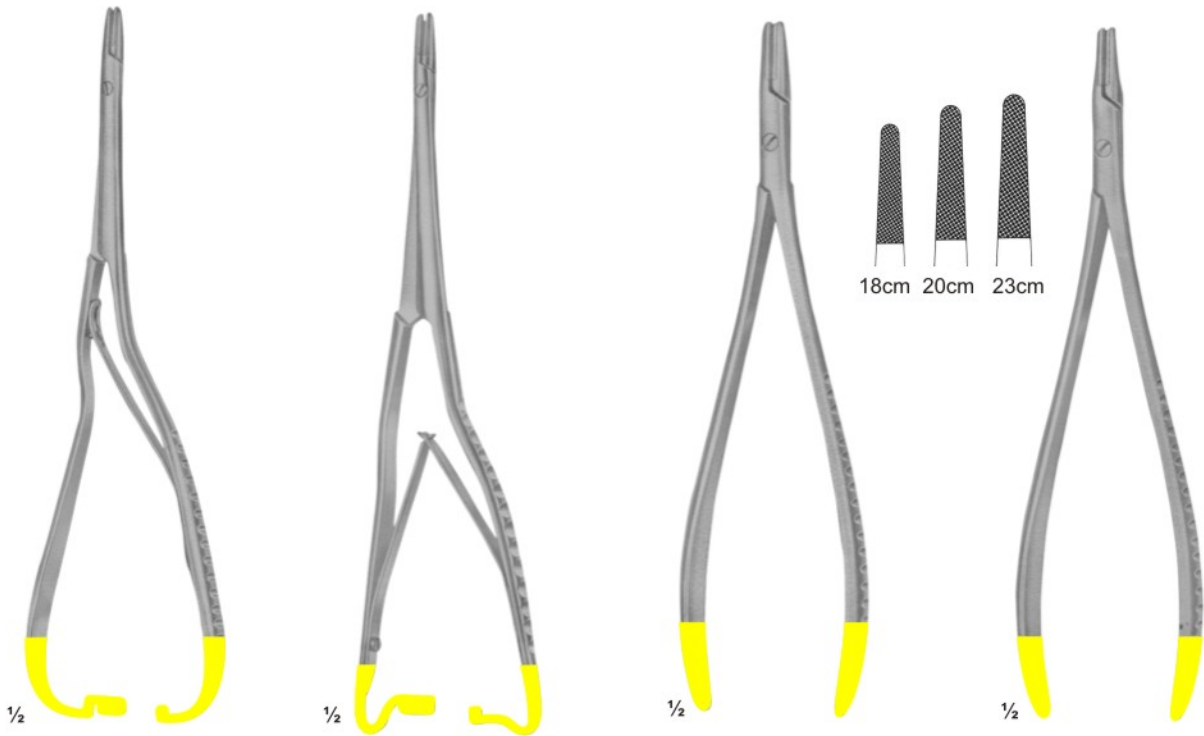

1/2
3105
LUEHTY-BECK
20,25 cm

1/2
3106
LUEHTY-BECK
20,25 cm

1/2
3107
LANGENBECK
18,20,23 cm

1/2
3108
LANGENBECK
18,20,23 cm

Wire Cutting Plier With T.C. Inserts



3109
TOENNIS
Elastic pattern for
dura-or intestinal suture
180 mm

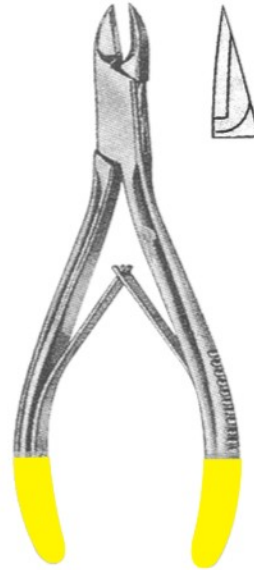

3110
Cutting Plier
12 cm

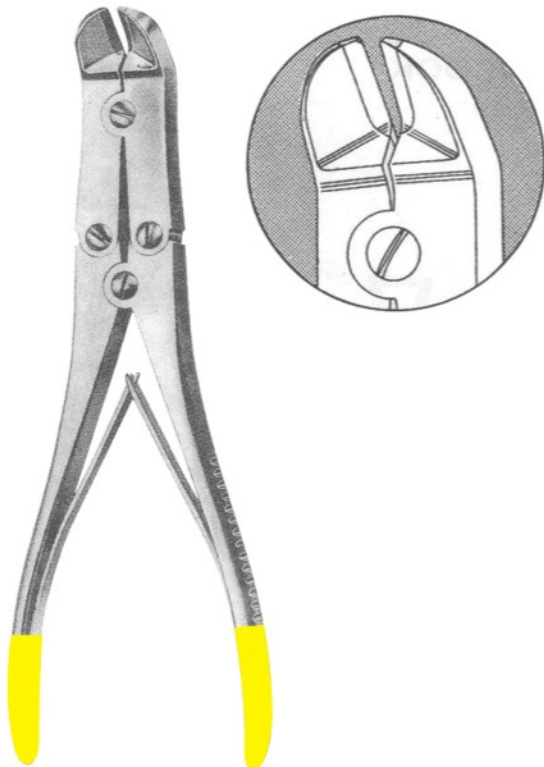

3111
MULLAR CLAUS
22 cm

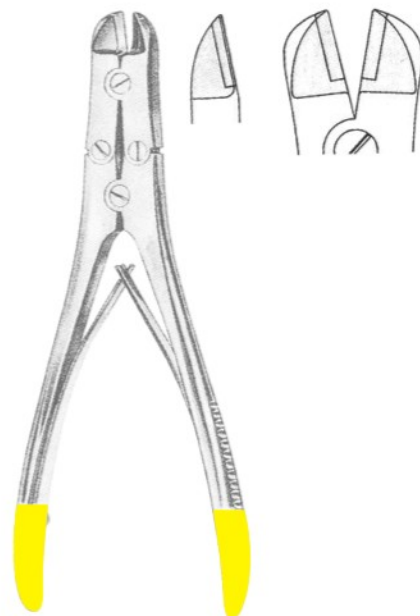

3112
Plier
17.5 cm



3201
Root Elevator



3202
Root Elevator



3203
Osteotomes
Pointed



3204
Osteotomes
Pointed



3205
Osteotomes Convex
Rounded Set of Five



3206
Luxator Set 7 Pcs

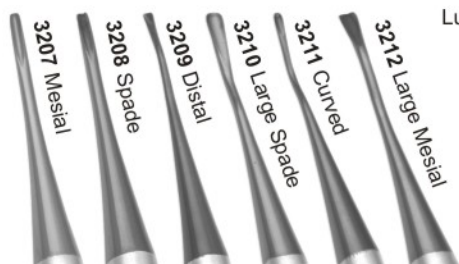

3213
Periodontal chisel
5mm / 3mm



3214
Sinus lift # 1
Set of Five

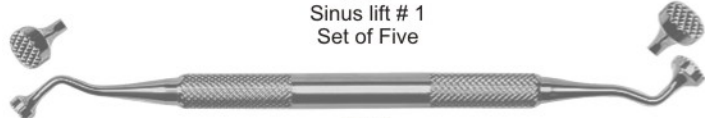

3215
Large Bone Packer
Serrated 5mm 7mm



3216
Labanca



3217
Sinus lift instruments



3218
Sinus lift instruments



3219
Replacement blade bone scraper
(curved) Three Type



3220
Adjustable-angle
Scalpel Blade Handle



3221
Replacement Blade
Bone Scraper (straight)



3222
Bone Tamper 4mm
Serrated Tip



3223
Bone Chisel



3224
Double Ended
Explorer



3225
Scaler



3226
Scaler



3227
Scaler



3228
Scaler

Dental Implants Instruments



3229
Frazier Suction tube
2.5 mm diameter



3230
luxator set 7 pcs
mesial curved



3231
luxator set 7 pcs
mesial curved

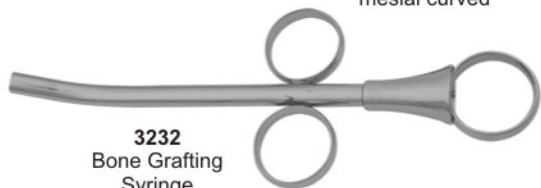

3232
Bone Grafting
Syringe



3233
inter-ligmental
Syringes



3234
inter-ligmental
Syringes



3235
Adjustable Torque
Wrench



3236
Mucotomes
(straight)



3237
Bone Miller

3238
Bone Well

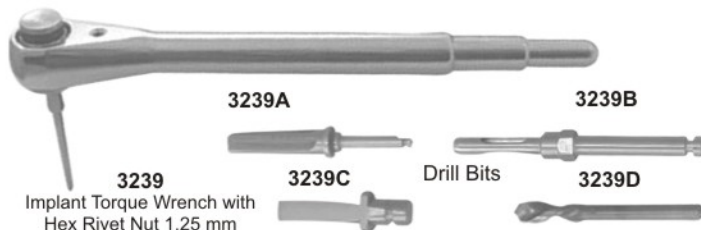

3239A
3239
Implant Torque Wrench with
Hex Rivet Nut 1.25 mm

3239B
3239C Drill Bits **3239D**



3240
Fig. 1 / Hemingway



3241
Fig. 2 / Hemingway

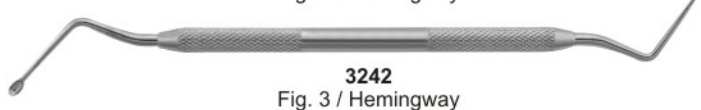

3242
Fig. 3 / Hemingway



3243
Fig. 3

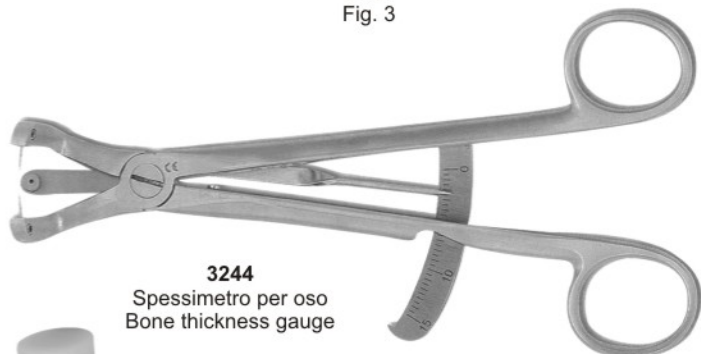

3244
Spessimetro per oso
Bone thickness gauge



3245
MALLET



3246
Dental implant fixture
removal kit

>trepines
>drivers
>end cutters

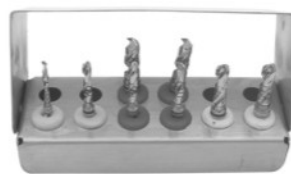

3247
Dental Trepine Drills
Set of Seven

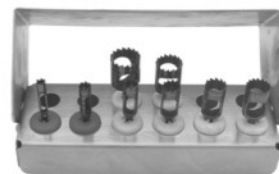

3248
Dental Trepine Drills
Set of Ten



3249
Set of 8 Pcs



3250
Set of 5 Pcs



3251
Set of 5 Pcs



3252
Set of 7 Pcs



Dental Instruments Sets



3253
Tooth Extracting Forceps Kit (Set of 12 pcs)
Fig #: 1,7,13,17,18,51A,67A,73,74N,86,89,90



3254
Pedo Forceps Kit (Set of 7 pcs)
Fig #: 560,561,562,563,565,566,567



3255
Root Elevators Kit (Set of 9 pcs)
A) Cross Bar Elevator #775/7
B) Cross Bar Elevator # 775/8
C) Elevator, Str. Hospital Pattern (Semi-Pointed)
D) Elevator-Coupland Back Crurver #2 (Lindoleven)
E) Elevator # 720/10
F) Elevator # 120/11
G) Elevator # 720/27
H) Elevator # 720/28



3256
Oral Surgical Instruments Kit
A) B.P. Handle # 3 - Round, Str.
B) Artery Forceps, Str. 5.5"
C) Needle Holder, Str. 6"
D) Gum Scissors # 1
E) Gum Scissors # 2
F) Moons Probe, (Flat Beak)
G) Bone Curettes # 780 (Lucas)
H) Bone Nibbler, Large with Hole
J) Periosteal Elevator



3257
Crown Remover Set
Full Automatic



3258
Rubber Dam
Instruments Set



3259
Gracey Curettes, (Set of 8 pcs)
Fig # 1/2,3/4,5/6,7/8,9/10,
11/12,13/14,15/16



3260
Subgingawal Scalers
(Set of 8 pcs S/E)



3261
Titanium Coated Filling Instruments
Hollow Handle (Set of 6 pcs)



3262
Titanium Coated Filling Instruments
(Set of 6 pcs)



Alphabetical Index

| A | |
|---------------------------------------|-------------|
| Adams, Pliers | 174 |
| Aderer, Pliers | 174 |
| Adson, Forceps | 158,207 |
| Adson, Tweezers | 151 |
| Ainsworth, Rubber Dam Punch | 147 |
| Albee | 143 |
| Albrecht, Tweezers | 155 |
| Allen, Tweezers | 155 |
| Allis, Tissue Forceps | 158 |
| Amalgam Applicators | 97 |
| Amalgam Condensers | 97 |
| Amalgam Pluggers | 97 |
| Amalgam Carriers | 145 |
| Amalgam Guns | 145 |
| Andresen, Pliers | 175 |
| Andrews, Tongue Depressor | 160 |
| Angle, Pliers | 169,174 |
| Apical, Elevator | 57,63 |
| Arruga, T.C. Needle Holder | 208,209 |
| Articulators | 194-195 |
| Aspirating Syringes | 149 |
| Allen 9A, Elevator | 50 |
| B | |
| Baby-Allis, Tissue Forceps | 158 |
| Band Removing Pliers | 170 |
| Bane, Rongeurs | 179 |
| Barnhart, Curettes | 110,116 |
| Barry, Elevator | 66,69 |
| Baum Gartner, Needle Holder | 180,211 |
| Bee Be, Scissors | 186 |
| Bein, Elevator | 54,61 |
| Beyer, Rongeurs | 179 |
| Bird Beak Pliers | 167 |
| Blumenthan, Rongeurs | 176 |
| Boley Gauge | 143 |
| Bone Curettes | 129 |
| Boynton, Needle Holder | 181 |
| Bozemann-Wertheim, T.C. Needle Holder | 210 |
| Bracket, Pliers | 170 |
| Brewer, Rubber Dam Instruments | 147 |
| Brown, Tissue Forceps | 158 |
| Brown-Adson, Tissue Forceps | 158 |
| Bruns, T.C. Scissors | 203 |
| Buchs, Retractor | 162 |
| Burnishers | 99-100 |
| Ball Chain | 146 |
| Boley Gauge, | 143 |
| Bone Gauge, | 144 |
| Bone Mill Forcep, | 139 |
| Bone Pluggers, | 140 |
| Bracket, Gauge | 144 |
| Buser, Elevator | 52 |
| C | |
| Carvers | 102,103 |
| Castroviejo, Needle Holder | 181,208,209 |
| Castroviejo, scissors | 186 |
| Castroviejo, Gauge | 144 |
| Castroviejo, Sclerer Marker | 144 |
| Cement Instruments | 118,119,121 |
| Cement Spatulas | 120,122 |
| Chisels | 103 |
| Chompret, Elevator | 63 |
| Cleveland, Rongeurs | 177,178 |
| College, Tweezers | 152,154 |
| Collier, Needle Holder | 180 |
| Collin, Retractor | 162 |
| Columbia, Curettes | 110,111,116 |
| Composite Placement | 104,105 |
| Con Scodellino, Wax Knives | 126 |
| Cord Packers | 95 |
| Cottle, Scissors | 184 |
| Coupland, Elevator | 58 |
| Crane-Kaplan | 128 |
| Crile, Forceps | 157 |
| Crile, Needle Holder | 181 |
| Crile-Wood, Needle Holder | 180 |
| Crown Instruments | 135,136 |
| Crown Removers | 134,135 |
| Crown Shell, Pliers | 166 |
| Cryer, Elevator | 55,58,69 |
| Cushing , T.C. Forceps | 207 |
| Cushing, Tweezers | 151 |
| Cushing-Taylor , T.C. Forceps | 207 |
| D | |
| De Bakey , T.C. Forceps | 207 |
| De Bakey, Scissors | 184,186,206 |
| De Bakey, T.C. Needle Holder | 209 |
| De La Rosa, Pliers | 169 |
| Deaver, Scissors | 184 |
| Denhart, Mouth Gag | 160 |
| Dental Implants Instruments | 214,216 |
| Dental Instruments Sets | 217 |
| Derf, Needle Holder | 180 |
| Disposable Products | 117 |
| Dr.Sader, Elevator | 69 |
| Dressing Forceps | 207 |
| Dean Scissors | 186,205 |
| E | |
| Elevators | 51 |
| Endodontic Condensers | 86,87 |
| Ermet, Wax Knives | 126 |
| Excavators | 89-91 |
| Explorers | 80-82,91-94 |
| Extracting forceps (American Pattern) | 36-49 |
| Extracting forceps (English Pattern) | 1-24 |
| Extracting forceps (fitting handle) | 25-33 |
| Extracting forceps (For Children) | 34 |
| F | |
| Fahnenstock, Wax Knives | 126 |
| Files | 125 |
| Filling Instruments | 106,107 |
| Fine, T.C. Scissors | 206 |
| Finocchio, T.C. Needle Holder | 211 |
| Finocchio, T.C. Needle Holder | 211 |
| Fischer, Pliers | 175 |
| Flagg, Tweezers | 154 |
| Flohr, Elevator | 56 |
| Fomon, Tissue Retractor | 164 |
| Freer, Elevator | 52 |
| Friedman, Rongeurs | 178 |
| Furrer, Pliers | 174 |
| Film Hanger | 146 |
| Finger Cup | 197 |
| Flohr, Elevator | 57 |
| Freer | 15,16 |





Alphabetical Index

| | | | |
|------------------------------------|-------------|--|-------------|
| Elevator | 52 | Langenbeck, Retractor | 162 |
| G | | Langenbeck, T.C. Needle Holder | 212 |
| Gardner, Bone Chisels | 132 | Langer, Curettes | 110,116 |
| Gardner, Needle Holder | 180 | Langhals, T.C. Needle Holder | 212 |
| Gardner, Rongeurs | 178 | Lecluse, Elevator | 65 |
| Gillies, Hook | 164 | Lessmann, Wax Knives | 126 |
| Gillies, Tweezers | 151 | Lexer, T.C. Scissors | 202 |
| Goldman Fox , T.C. Scissors | 206 | Lichtenberg, T.C. Needle Holder | 212 |
| Goldman Fox, Curettes | 112,113 | Ligature , T.C. Scissors | 207 |
| Goldman Fox 14, Elevator | 50 | Lip & Cheek Retractors | 161,162 |
| Goldman Fox, knives | 114 | Lister, Scissors | 184 |
| Goslee, Pliers | 175 | Littauer, Scissors | 186 |
| Gracey Curettes | 108,109,116 | Littler, Scissors | 184 |
| | | Locklin, Scissors | 186 |
| H | | London Hospital, Elevator | 62 |
| Halsey, T.C. Needle Holder | 209 | London-College, Tweezers | 154,155 |
| Handles | 72 | Lucae, T.C. Forceps | |
| Hartman, Rongeurs | 179 | Luehty-Beck, T.C. Needle Holder | 212 |
| Hatchets | 95 | Lwanson, Crown Gauge | 143 |
| Heaney, T.C. Needle Holder | 211 | Lagrange, Scissors | 186,205 |
| Hegar, T.C. Needle Holder | 209 | Littaure, Scissors | 186 |
| Hegar-Vascular, T.C. Needle Holder | 209 | Lwanson, Crown Gauge | 143 |
| Heidbrink, Elevator | 64,67,69 | M | |
| Heidbrink, Elevator | 57 | Martin, T.C. Needle Holder | 210 |
| Howard 9H, Elevator | 52 | Mathieu, Needle Holder | 181,211 |
| Height Gauge, | 143 | Mathieu-Kosher, T.C. Needle Holder | 211 |
| Hepp-Scheidle, T.C. Needle Holder | 208 | Mathieu-Ryder, T.C. Needle Holder | 212 |
| Hlsted-Mosquito, Forceps | 159 | Mathieu-Vascular, T.C. Needle Holder | 211 |
| Hoes | 95,125 | Mayo Harrington, T.C. Scissors | 205 |
| Hollow Wares | 196-200 | Mayo, Scissors | 185,204 |
| How, Pliers | 167,174 | Mayo-Hegar, Needle Holder | 181 |
| Howard, Bone Files | 131 | Mayo-Hegar, T.C. Needle Holder | 209 |
| Hylin, Elevator | 61 | Mayo-Lexer, T.C. Scissors | 202 |
| | | Mayo-Stille, T.C. Scissors | 202 |
| I | | Mayo-Stille Scissors | 185 |
| Implants Instruments | 137-141 | Mc Kellops, Pliers | 175 |
| Impression Trays | 187-193 | Mccalls, Curettes | 110,111,116 |
| Iris Scissors | 183 | Mcindoe, Tweezers | 151 |
| Ivory, Rubber Dam Instruments | 147 | Mead, Bone Mallets | 133 |
| | | Mead, Elevator | 64 |
| J | | Mead, Rongeurs | 179 |
| Jarabak, Pliers | 165 | Meriam , T.C. Forceps | 207 |
| Jeseph, Scissors | 183 | Meriam, Tweezers | 153,155 |
| Johnson, Pliers | 169,175 | Metzenbaum Fino, T.C. Scissors | 203,204 |
| Joseph, Tissue Retractor | 164 | Metzenbaum, Scissors | 185,203 |
| | | Micro Surgery Set | 182 |
| K | | Micro-Adson, Tweezers | 151 |
| Kalt, T.C. Needle Holder | 208 | Micro-Friedman, Rongeurs | 178 |
| Kelly, Forceps | 159 | Middledorpf Retractor | 162 |
| Kelly, Scissors | 183 | Miller, Articulating Forceps | 147 |
| Kelly Scissors | 205 | Miller, Bone Files | 130 |
| Kim's Plier | 165 | Mini-Blumenthan, Rongeurs | 176 |
| Kirkland, knife | 114 | Molt, Elevator | 50 |
| Knives | 125 | Molt, Mouth Gag | 160 |
| Knowles, Scissors | 184 | Molt 9, Elevator | 50 |
| Kocher, Retractor | 162 | Morrison, Elevator | 56 |
| Kocher-Langenbeck, Retractor | 162 | Mouth Mirrors with Handles | 73 |
| Kopp, Elevator | 60,68 | MSY, Pliers | 175 |
| Kopp , Tweezers | 151 | Mullar Claus, Wire Cutting Pliers T.C. | 213 |
| | | N | |
| L | | Nance, Pliers | 168,169,174 |
| Lab & Office Pliers | 166 | Napkin Holders | 146 |
| Landgraf, Tweezers | 154 | Neivert, Needle Holder | 180 |
| Langenbeck, Pliers | 175 | Nelson-Metzenbaum, Scissors | 185 |
| | | Non Chill | 146 |



Alphabetical Index

O

| | |
|------------------------------|-----|
| O'Brien, Pliers | 168 |
| Obturation Instruments | 88 |
| Ochsenbein | 128 |
| Ordan, knife | 114 |
| Oehler, T.C. Forceps | 208 |
| Olsen-Hegar, Needle Holder | 180 |
| Optical Pliers | 168 |
| Orthodontic Cutters, T.C. | 172 |
| Orthodontic Distal & Cutters | 173 |
| Orthodontic Pliers, T.C. | 171 |
| Ott, Elevator | 62 |

P

| | |
|---------------------------------|-------------|
| Parametrium, T.C. Scissors | 205 |
| Partsch, Bone Chisels | 133 |
| Partsch, Bone Mallet | 133 |
| Pean, Forceps | 157 |
| Peeso, Pliers | 166,175 |
| Peets, Forceps | 157 |
| Perry, Tweezers | 151 |
| P.K. Thomas, | 9696 |
| Pich, | 9898 |
| Pluggers, | 9898 |
| Prichard, Elevator | 5050 |
| Plastic Handle Elevators | 70 |
| Polokoff, Bone File | 131 |
| Pott, Elevator | 51 |
| Potts-Smith, T.C. Forceps | 208 |
| Potts-Smith, T.C. Needle Holder | 208 |
| Probes | 82-85,91,94 |

Q

| | |
|------------------|-----|
| Quinby, Scissors | 183 |
|------------------|-----|

R

| | |
|------------------------------------|---------|
| Ragnell , T.C. Scissors | 206 |
| Retainers, Bands | 146 |
| Reynolds, Pliers | 169,174 |
| Root Planning Curettes | 115 |
| Root splinter forceps | 35 |
| Roux, Retractor | 162 |
| Rubber Dam Clamps | 148 |
| Rubber Dam Holder | 147 |
| Rule, Curette | 110 |
| Russian, Tissue Forceps | 158 |
| Ryder, T.C. Needle Holder | 210 |
| Ryder-Vascular, T.C. Needle Holder | 210 |

S

| | |
|---------------------------|----------|
| Sarot, T.C. Needle Holder | 210 |
| Scalers | 75-79 |
| Scalpel Handles | 71 |
| Schwarz, Pliers | 168,175 |
| Schluger, File | 114 |
| Seldin, Elevator | 50,55,67 |
| Select, Tweezers | 151 |
| Semken, T.C. Forceps | 207 |
| Semkin, Tissue Forceps | 158 |
| Senn, Tissue Retractor | 164 |
| Separating Pliers | 166 |
| Sims, T.C. Scissors | 205 |
| Spatulas | 123 |
| Spencer, Scissors | 186 |
| Spencer-Wells, Forceps | 157 |

| | |
|-------------------------------|---------|
| Spreaders | 87 |
| Split Chisels, | 128 |
| Spring Bow Divider | 143 |
| Standard, T.C. Scissors | 201 |
| Standard, Tweezers | 151 |
| Steiner, Pliers | 166 |
| Sterilizing & Lab Instruments | 156 |
| Sterilizing Forceps, | 163 |
| Stevens, Needle Holder | 181 |
| Stevens, Scissors | 183 |
| Stille, Scissors | 185 |
| Stratte, T.C. Needle Holder | 210 |
| Strip Holder Clips | 146 |
| Syringes | 150 |
| Suction Tubes, | 140,142 |
| Sugarman, File | 114 |

T

| | |
|-----------------------------------|-----|
| Toennis, Wire Cutting Pliers T.C. | 213 |
| Toennis-Adson, Scissors | 184 |
| Toennis, Tissue Retractor | 164 |
| Towel Clamps, Napkin Holders | 159 |
| Tweed, Pliers | 168 |
| Telescope, Crown Plier | 136 |
| Traymann, Crown Remover | 128 |

U

| | |
|---------------------------|-----|
| Universal , T.C. Scissors | 207 |
| Universal, Pliers | 174 |
| Universal, Elevator | 135 |
| Utility Plier | 165 |

V

| | |
|--------------------------------|-----|
| Vernier, Measuring Instruments | 143 |
| Vernier Gauge | 143 |

W

| | |
|------------------------------|-------------|
| Wakefield, Bone Chisels | 132 |
| Waldron, Pliers | 174 |
| Waldsachs, Pliers | 174 |
| Wangensteen, T.C. Forceps | 208 |
| Warwick-James, Elevator | 62 |
| Waugh, Tweezers | 151 |
| Wax & Modeling Carvers | 120 |
| Wax & Plaster Knives | 127 |
| Wax Carvers | 101 |
| Wax, Porcelain Instruments | 118,119,121 |
| Webster, Needle Holder | 180,209 |
| Weingart , Utility Pliers | 167 |
| Weitlaner, Retractor | 160 |
| West, Elevator | 50 |
| White, Rubber Dam Instrument | 147 |
| Wieder, Tongue Depressor | 160 |
| Winter, Elevator | 65,69 |
| Wire & Clasp Bending Pliers | 170 |
| Wire Bending Pliers | 166 |
| West, Elevator | 50 |
| Wire Cutter | 165 |
| Woodson, | 98 |

Y

| | |
|---------------|---------|
| Young, Pliers | 168,174 |
|---------------|---------|

Z

| | |
|--------------------------------|-----|
| Zuricher, Measuring Instrument | 143 |
| Zuricher, Gauge | 143 |



www.sialkotsurgical.com

Manufacturers & Suppliers of Standard
and Customized Dental Instruments



Stellar[®]
Instruments Co.

ISO 9001:2008 CERTIFIED :: CE-MARK

Factory: B-VIII, 93/A, Circular Road Daska (51010) Sialkot.
Punjab – Pakistan.

Call & WhatsApp: +92 317 1778080
E-mail: info@sialkotsurgical.com
Website: www.sialkotsurgical.com
