

TABLE OF CONTENTS







DESCRIPTION	SECTION	PAGE #	
01: Diagnostic, Anaesthesia, Scalpels & Knives	01	1 - 22	
02: Scissors	02	23 - 51	
03: Forceps, Clamps	02	52 - 95	
04: Needle Holders, Micro Needle Holders	02	96 - 101	
05: Suture Instruments, Needles, Probes, Applicators, Pocket Instruments Set.	02	102 - 114	
06: Hooks, Retractors, Spatulas, Spreaders, Abdominal Retractors	03	115 - 167	
07: Forceps, Intestinal Clamps, Specula, Biopsy Forceps, Anusscopes	03	168 - 193	

TABLE OF CONTENTS



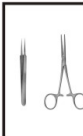







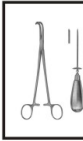

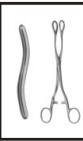
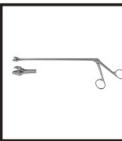
DESCRIPTION	SECTION	PAGE #	
08: Gall Duct Forceps / Probes / Scissors / Kidney Forceps, Urinary Instruments, Trocars	03	194 - 208	
09: Vaginal Specula & Retractors	04	209 - 220	
10: Utrine Dilators, Probes, Forceps, Myoma Instruments	04	221 - 236	
11: Biopsy Instruments, Utrine Curettes / Scoops	04	237 - 245	
12: Obstetrics Instruments	04	246 - 254	
13: Tracheotomy, Cardiovascular & Thoracic Surgery	05	255 - 309	
14: Bone Punches & Rongeurs	05	310 - 318	

TABLE OF CONTENTS

DESCRIPTION	SECTION	PAGE #	
15: Amputation, Elevators, Saws, Raspatories, Bone Livers, Bone Files & Curettes	06	319 - 347	
16: Mallets, Tampers, Chisels, Gauges, Bone Holding Forceps, Bone Rongeurs, Bone Cutting Forceps, Meniscus Instruments	06	348 - 379	
17: Wire Extension, Finger Nail Instruments	06	380 - 392	
18: Plaster Instruments	07	393 - 397	
19: Suction Instruments	07	398 - 404	
20: TUNGSTEN CARBIDE INSERTS	07	405 - 421	
21: HOSPITAL WARES	07	422 - 432	

Percussion Hammers & Aesthesiometers

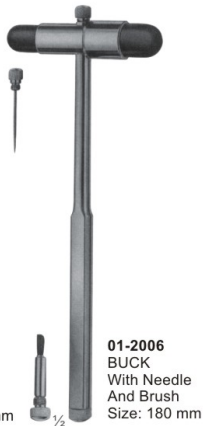

Stethoscopes



01-2010
PINARD
of aluminium
Size: 155 mm

½



01-2011
aus Holz
Wooden
Size: 145 mm

½



01-2012
BOWLES
Stethoscope With
Diaphragm,
In Plastic Pouch

¼



01-2013
ANESTOPHON
Ø47mm

½

01-2014
FORD-BOWLES
Combination Stethoscope
With Diaphragm and Bell
Dual Chest Piece
With Two Outlets



¼

01-2015
BOWLES
Stethoscope With
Diaphragm,
Flat Model,
Suitable Also
For Anaesthesia
Chest Piece Only
40 mm Diam



¼

Head Mirrors & Head Bands



01-2016
ZIEGLER Ø 90mm
Head mirror only
with rubber coating

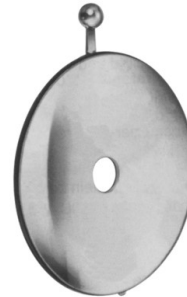

01-2017
ZIEGLER Ø 90mm
Head mirror only
with metal coating



01-2018
ZIEGLER
Head band of plastic, black only

01-2019
ZIEGLER
Head band of plastic, white only

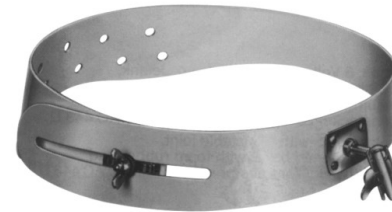

01-2020
MURPHY
Head band of celluloid, white only

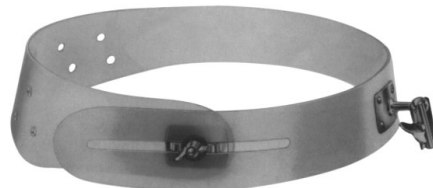

01-2021
Head band of plastic,
white, soft pattern



01-2022
Head mirror
with black plastic head
band

Head Lights



01-2026
spare bulb

01-2023
CLAR
Head light, 6 volt, with adjustable joint,
white celluloid head band,
cord with plugs for transformer

01-2024
White celluloid head band, only, for **01-2023**

01-2025
Spare mirror only, for **01-2023**

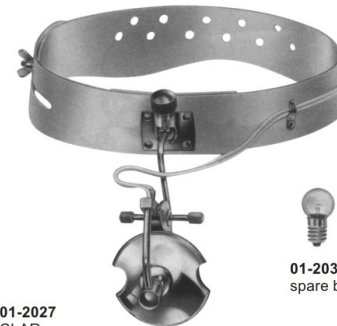

01-2031
spare bulb

01-2027
CLAR
Head light, 6 volt, with adjustable joint,
white celluloid head band, with foam rubber pad
and cord with plugs for transformer

01-2028
White celluloid head band, only, for head light

01-2029
mirror only, for head light

01-2030
spare foam rubber pad, for head band



01-2033
spare bulb

01-2032
JANSEN
Head light, 6 volt, with adjustable joint,
white plastic head band,
cord with plugs for transformer



01-2035
spare bulb

01-2034
LANGENBECK
Head light, 3.7 volt, with
adjustable joint,
white plastic head band,
cord with plugs for
transformer

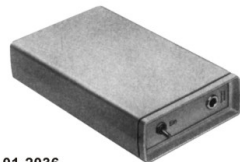

01-2036
HERBERHOLD
Pocket-Accu, 6 volts, with cord for head lights



01-2037
Extension cord only, to connect
the accu to the cord of the head lights



01-2038
Charging Set for pocket
accu **01-2036**
mains current: 220-240
volts, 50-60 Hz



01-2039
220 volt / 220 volts
01-2040
120 volt / 120 volts
Transformer

Tongue Depressors, Retractors

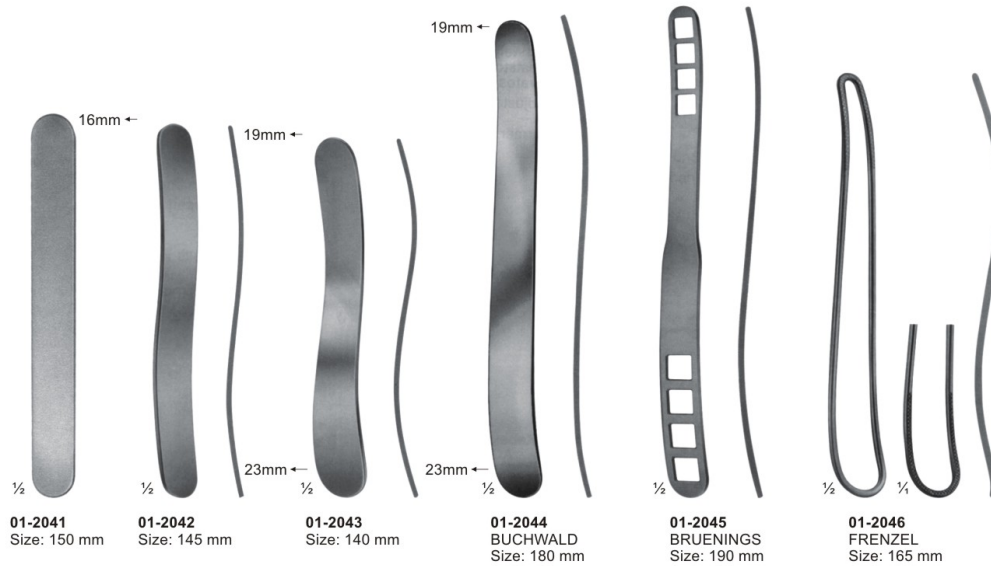

01-2041
Size: 150 mm

01-2042
Size: 145 mm

01-2043
Size: 140 mm

01-2044
BUCHWALD
Size: 180 mm

01-2045
BRUENINGS
Size: 190 mm

01-2046
FRENZEL
Size: 165 mm

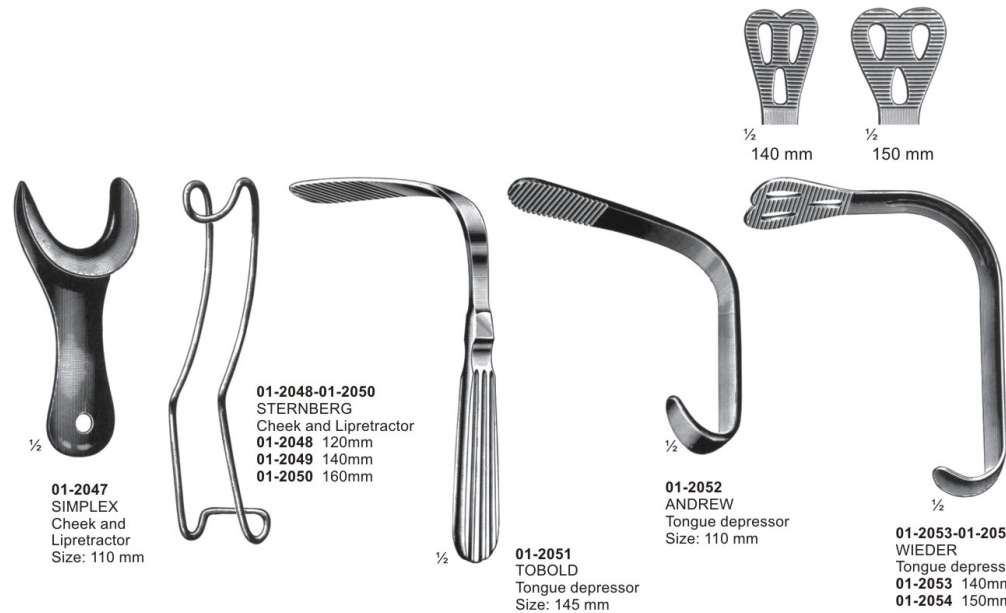

01-2047
SIMPLEX
Cheek and
Lipretractor
Size: 110 mm

01-2048-01-2050
STERNBERG
Cheek and Lipretractor
01-2048 120mm
01-2049 140mm
01-2050 160mm

01-2051
TOBOLD
Tongue depressor
Size: 145 mm

01-2052
ANDREW
Tongue depressor
Size: 110 mm

01-2053-01-2054
WIEDER
Tongue depressor
01-2053 140mm
01-2054 150mm

1/2
140 mm

1/2
150 mm

Mouth Gags And Tongue Forceps



½
01-2055
SCHIMMELBUSCH
Ether Mask



½
01-2056
HEISTER
Mouth Gag
Size: 130 mm



½
01-2057
FERGUSSON-ACKLAND
Mouth Gag
Size: 145 mm



½
01-2058
DENHARDT
Mouth Gag With
Silicon Inserts,
Interchangeable
Size: 125 mm



½
01-2059-01-2060
ROSER KOENIG
Mouth Gag
Size: **01-2059** 160mm
01-2060 185mm



½
01-2061
YOUNG
Size: 165 mm

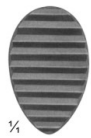

¼
01-2062
1 Pair Of
Rubber Pads

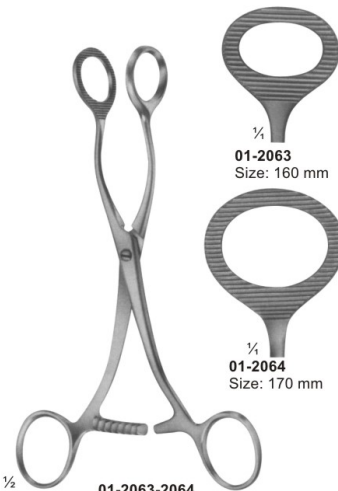

½
01-2063-2064
COLLIN



¼
01-2063
Size: 160 mm



¼
01-2064
Size: 170 mm

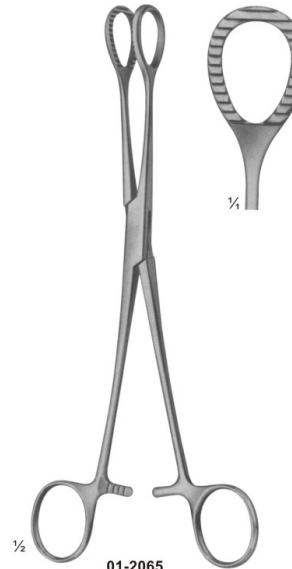

½
01-2065
HEYWOOD-SMITH modif.
Size: 215 mm

Blood Lancets & Laryngeal Mirrors

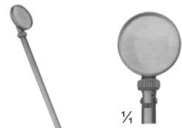

¼

01-2067
Ø 12 mm
Spare Mirrors Only



¼

01-2068
Ø 14 mm
Spare Mirrors Only



½

01-2066
MICHEL
Rhinoscopic Mirrors
With Interchangeable
Mirror Inserts
Size: 250 mm



½

01-2069
Mirror Handle
Size: 110 mm



½

01-2070
Mirror Handle
Size: 105 mm



½

01-2071
FRANCKE
Automatic
Blood Lancet



01-2072
KOLLE
Microscopic
Needle Holder
With Plastic
Handle
Size: 240 mm



½

01-2073
Laryngeal Mirrors With
Hexagonal Handle
Size: 180 mm



Fig. 000
Ø 6mm



Fig. 00
Ø 8mm



Fig. 0
Ø 10mm



Fig. 1
Ø 12mm



Fig. 2
Ø 14mm



Fig. 3
Ø 16mm



Fig. 4
Ø 18mm

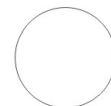

Fig. 5
Ø 20mm

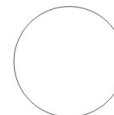

Fig. 6
Ø 22mm

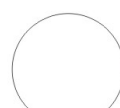

Fig. 7
Ø 24mm



Fig. 8
Ø 26mm

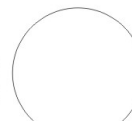

Fig. 9
Ø 28mm

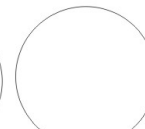

Fig. 10
Ø 30mm

Diagnostic Sets



1/2

01-2074 - 01-2076
MAGILL
Catheter Introducing
Forceps



01-2074
Infants
Size: 150 mm



01-2075
Children
Size: 200 mm



01-2076
Adults
Size: 250 mm



1/2

01-2077
Medium battery handle
only, 25 mm diam.



01-2078
Spare bulb
2.7 volt, for
Otoscopies etc.



01-2079
Spare bulb
2.6 volt, for
ophthalmoscopes



01-2080
Otoscope Set, Consists Of
Battery Handle Without Batteries,
3 Ear Specula, 1 Bulb In Velvet Lined Case



01-2081
Diagnostic Set, Otoscope With Three Specula,
Nasal Speculum, Lamp Holder, Two Laryngeal
Mirrors, Tongue Blade Holder

Laryngoscopes



01-2082
MILLER
Laryngoscope Set, Consists Of Battery Handle (Without Battery)
With Five Miller Laryngoscope Blades, Fig 1 to 5



01-2083
GUEDEL-NEGUS
Laryngoscope Set, Consists Of Battery Handle (Without Battery)
With Four Miller Laryngoscope Blades



Fig. 0



Fig. 1



Fig. 2



Fig. 3



Fig. 4

- 01-2082 A** Fig. 0 Working Length, 55 mm (Baby's) 1/2
- 01-2082 B** Fig. 1 Working Length, 80 mm (Children's)
- 01-2082 C** Fig. 2 Working Length, 130 mm (Adolescent's)
- 01-2082 D** Fig. 3 Working Length, 170 mm (Women's)
- 01-2082 E** Fig. 4 Working Length, 180 mm (Men's)



Fig. 1



Fig. 2



Fig. 3



Fig. 4

- 01-2083 A** Fig. 1 Working Length, 70 mm (Children's)
- 01-2083 B** Fig. 2 Working Length, 90 mm (Adolescent's)
- 01-2083 C** Fig. 3 Working Length, 110 mm (Women's)
- 01-2083 D** Fig. 4 Working Length, 135 mm (Men's)

Laryngoscopes



01-2084
McINTOSH
Laryngoscope Set, Consists Of Battery Handle (Without Battery)
With Three McIntosh Blades, Fig. 1, Fig. 2, Fig. 3

01-2085
McINTOSH
Laryngoscope Set, Consists Of Battery Handle (Without Battery)
With Five McIntosh Blades, Fig. 0, Fig. 1, Fig. 2, Fig. 3, Fig. 4

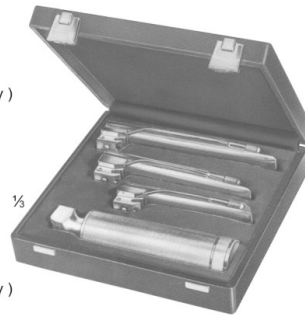

01-2086
FOREGGER
Laryngoscope Set, Consists Of
Battery Handle (Without Battery)
With Three Foregger Blades,
Fig. 1, Fig. 2, Fig. 3.

01-2087
FOREGGER
Laryngoscope Set, Consists Of
Battery Handle (Without Battery)
With Four Foregger Blades,
Fig. 1, Fig. 2, Fig. 3, Fig. 4.



01-2088
Fiber Optic
Battery Handle
30mm diam.



01-2089
Fiber Optic
Battery Handle
18mm diam.



01-2090
Replacement Lamp
(Krypton) 2.5 V



01-2091
Replacement Lamp
(Halogen) 2.5 V



Fig. 0



Fig. 1



Fig. 2



Fig. 3



Fig. 4

01-2085 A Fig. 0 Working Length, 55 mm (Baby's)
01-2085 B Fig. 1 Working Length, 75 mm (Children's)
01-2085 C Fig. 2 Working Length, 90 mm (Adolescent's)
01-2085 D Fig. 3 Working Length, 110 mm (Women's)
01-2085 E Fig. 4 Working Length, 135 mm (Men's)



Fig. 1



Fig. 2



Fig. 3



Fig. 4

01-2086 A Fig. 1 Working Length, 70 mm (Children's)
01-2086 B Fig. 2 Working Length, 90 mm (Adolescent's)
01-2086 C Fig. 3 Working Length, 110 mm (Women's)
01-2086 D Fig. 4 Working Length, 135 mm (Men's)

Examination & Measuring Instruments

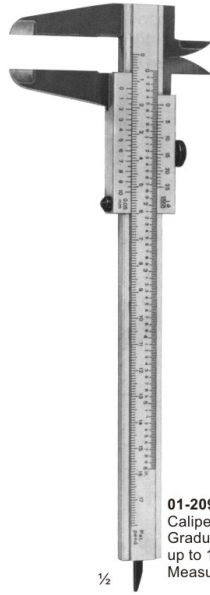

01-2092
Caliper Of Aluminium
Graduated in mm & inches
up to 180mm
Measuring Range up to 139mm



01-2093
VERNIER
Universal Caliper Of Steel
Graduated in mm & inches
up to 180mm
Measuring Range up to 120mm
with Vernier in 1/10mm & 1/16"



01-2094
CARROLL
Size: 145 mm
Finger Goniometer



01-2095
TOWNLEY
Graduated in
mm & inches
Size: 115 mm



01-2096
COLLIN
Druck Pressure 72 kg
Size: 125 mm



01-2097
BERTILLON
Caliper For Measuring The Head
Size: 320 mm



01-2098
CASTROVIEJO
Caliper
Size: 75mm



01-2099
MOLTGEN
Goniometer



01-2100A
Size: 150 mm



01-2100
Size: 500 mm



Dissecting Knives



01-2101 - 01-2110
Fig. 1 - 10
With Metal Handle



01-2101
Fig. 1
Size: 30mm
15cm



01-2102
Fig. 2
Size: 36mm
15cm



01-2103
Fig. 3
Size: 40mm
15.5cm



01-2104
Fig. 4
Size: 45mm
16cm



01-2105
Fig. 5
Size: 50mm
16cm



01-2106
Fig. 6
Size: 27mm
15cm



01-2107
Fig. 7
Size: 35mm
15cm



01-2108
Fig. 8
Size: 40mm
16cm



01-2109
Fig. 9
Size: 47mm
16cm



01-2110
Fig. 10
Size: 50mm
17cm

Autopsy & Cartilage Knives

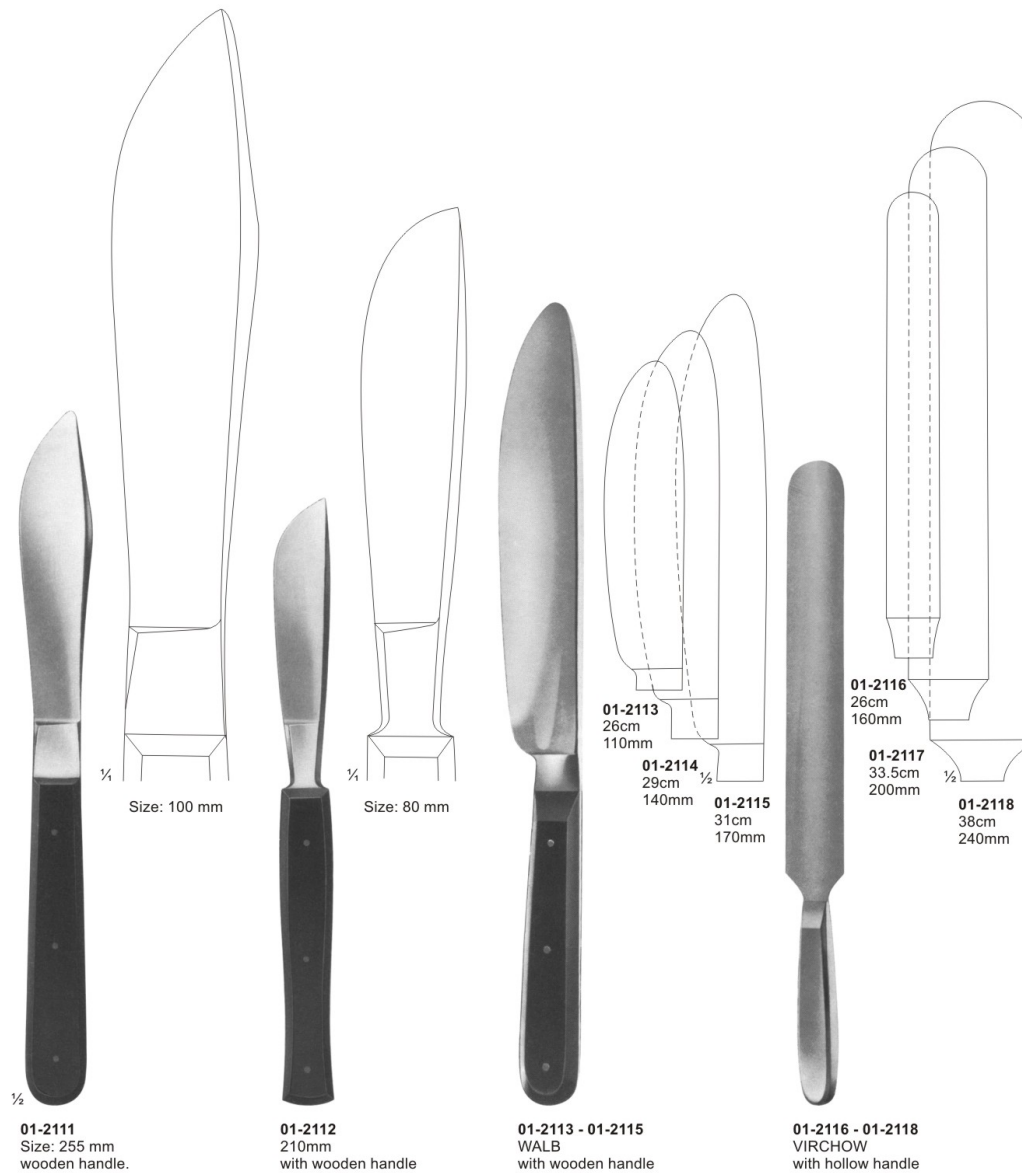

Scalpels, Tenotomes & Resection Knives

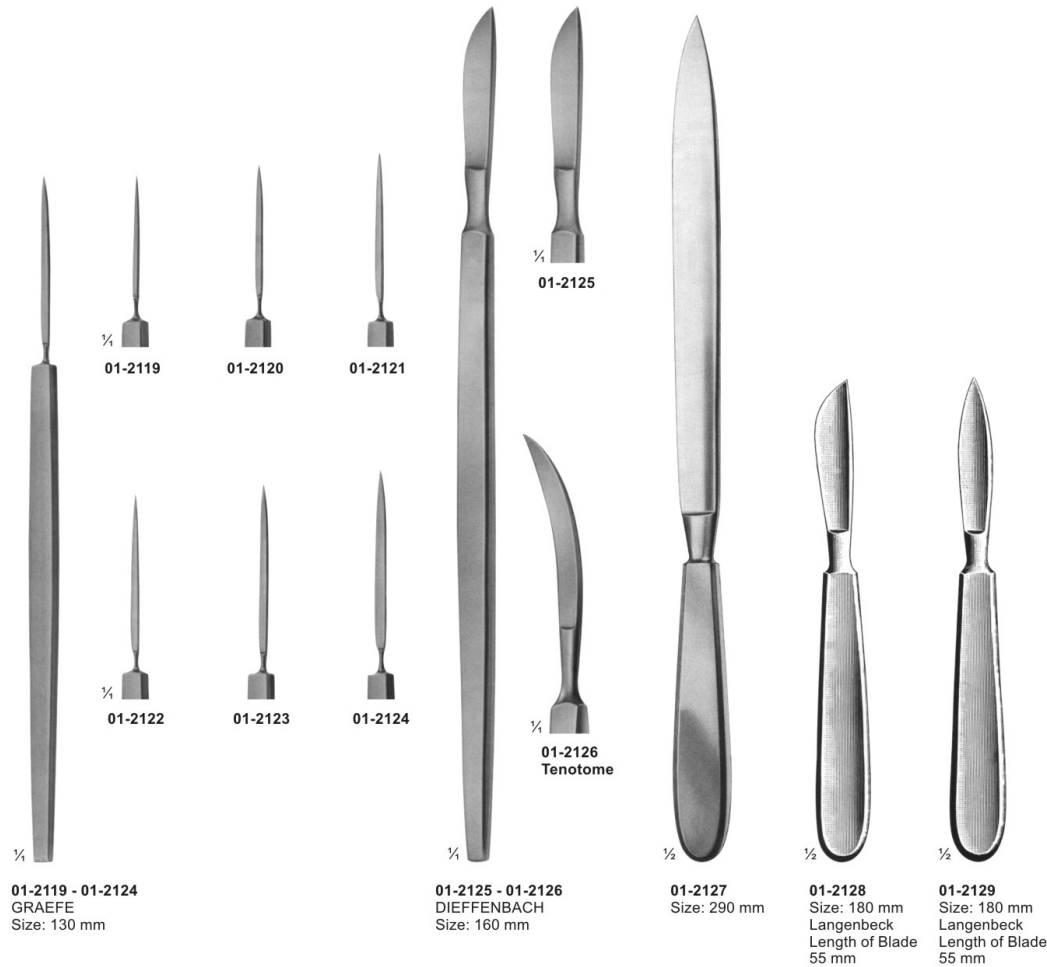

Scalpels, Tenotomes

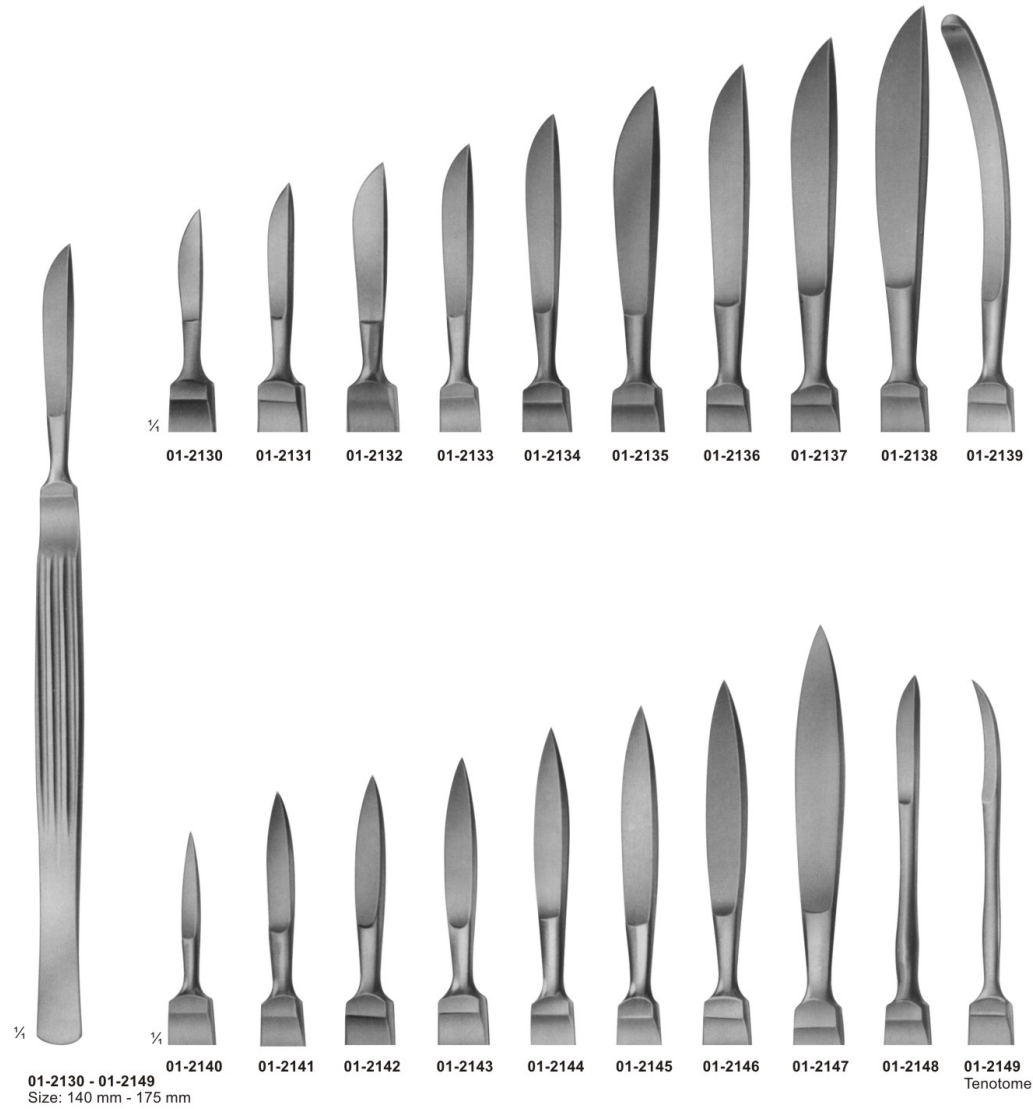

**Amputating Knives, Cartilage Knives,
Autopsy Knives**

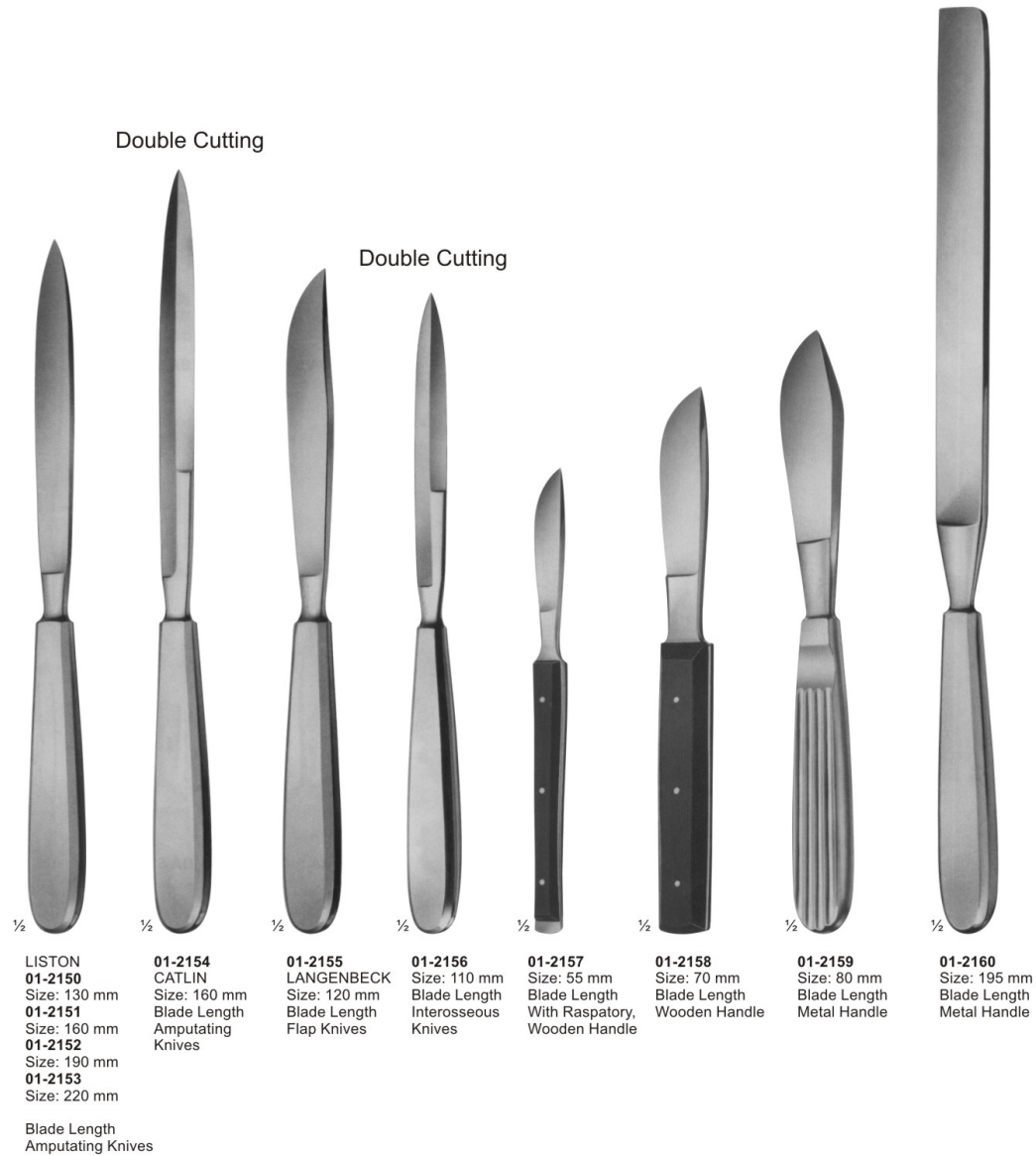

**Cone Knives, Myomatome,
Trigeminal & Tonsil Knives**



01-2161
AYRE
Size: 235 mm
Cone Knife

01-2162
Size: 230 mm
Cone Knife

01-2163
SEGOND
Size: 270 mm
Myomatome

01-2164
OLIVECRONA
Size: 205 mm
Trigeminal
Knife

01-2165
Size: 230 mm
Trigeminal
Knife

01-2166
FOWLER
Size: 200 mm
Tonsil Knife

01-2167
ABRAHAM
Size: 215 mm
Tonsil Knife

01-2168
BRUENINGS
Size: 215 mm
Tonsil Knife

Scalpels, Dura Knives & Comedone Extractors



01-2169
Straight



01-2170
Curved

01-2169 - 01-2170
JOSEPH
Size: 145 mm
Double Edged
Nasal Knives, Pointed



01-2171
Small



01-2172
Large



01-2173
Pointed

01-2171 - 01-2173
ZIEGLER
Size: 120 mm
Miliun Knives



01-2174
VIDAL
Lupus Scraper
Size: 135 mm

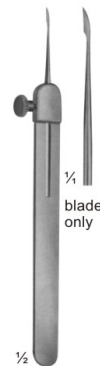

01-2175
MONCORPS
Miliun Knives
Size: 130 mm



01-2176
SAALFELD
Size: 100 mm

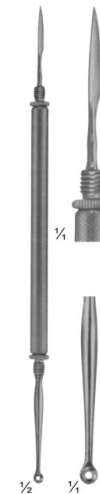

01-2177
HEBRA
Size: 180 mm



01-2178
Size: 145 mm



01-2179
UNNA
Size: 145 mm

Razor Blade Holders & Breakers

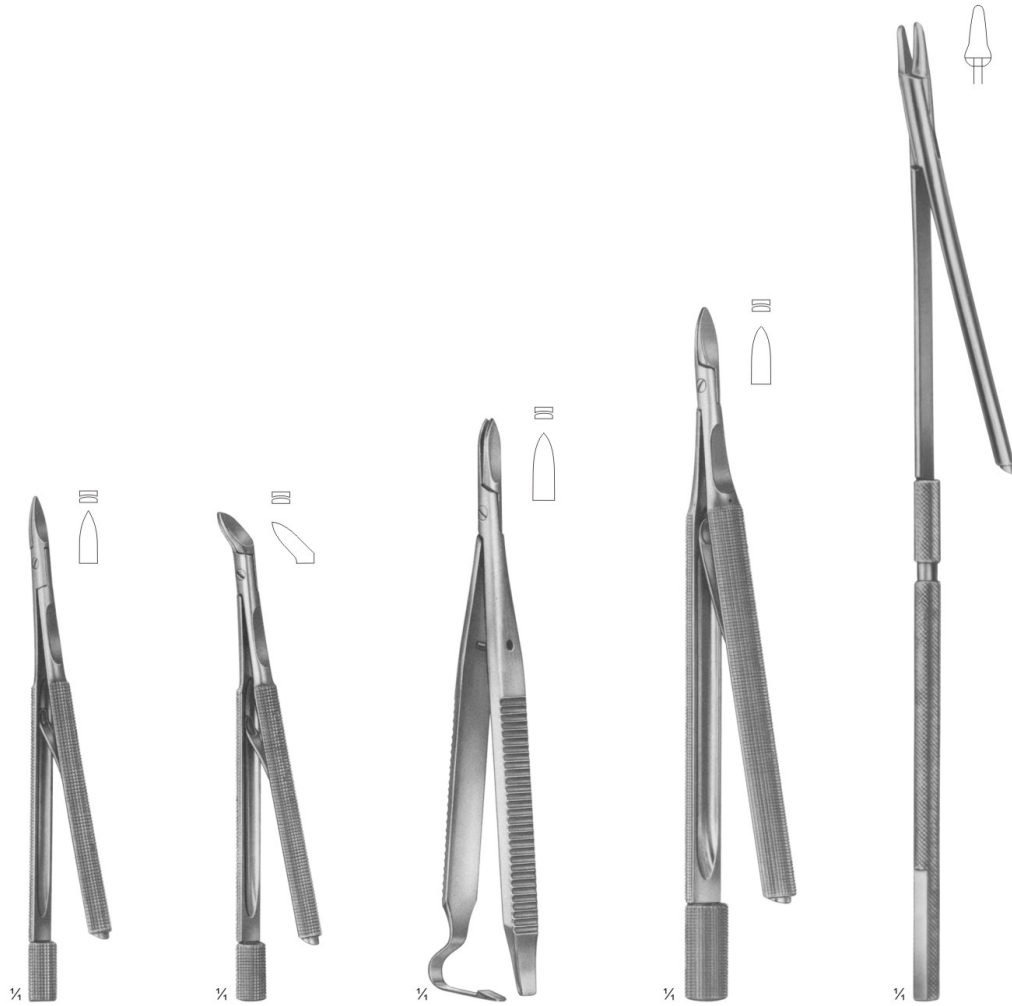

01-2180
TROUTMAN-CHRIS
Size: 90 mm
Handle Diameter 5.5 mm

01-2181
TROUTMAN-CHRIS
Size: 90 mm
Handle Diameter 5.5 mm

01-2182
Size: 110 mm

01-2183
CASTROVIEJO
Size: 130 mm
Handle Diameter 8 mm

01-2184
Size: 185 mm
Razor Blade
Breaker & Holder,
Straight

Scalpel Handles



01-2185
STANDARD
No. 4
Solid

01-2186
Double Handle
No. 4 + No. 3
Solid

01-2187
No. 4 L
Straight
Solid

01-2188
No. 4 L
Solid Angled

01-2189
COLLIN
No. 8
Hollow

01-2190
COLLIN
No. 9
Hollow

01-2191
Plastic
No.4

Scalpel Handles

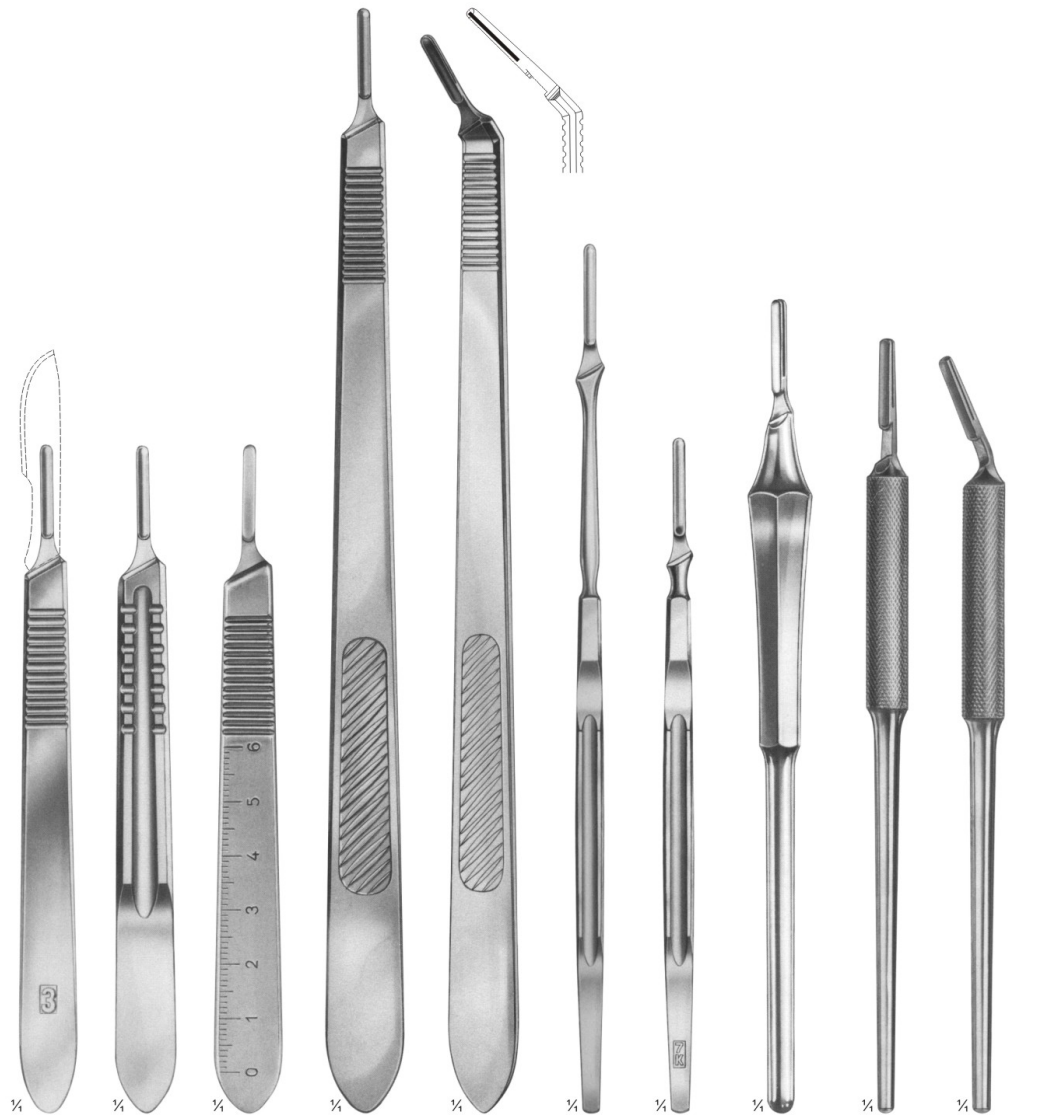

01-2192 STANDARD No. 3 Solid Size:12cm	01-2193 No. 3 Solid Size:12cm solid handle style as No.4	01-2194 No. 3 Solid Size:12cm cm-graduation	01-2195 No. 3 L Straight Solid, long Size:21.5cm	01-2196 No. 3 L Angled Solid, long Size:21cm	01-2197 No. 7 Solid Size:16cm	01-2198 No. 7 K Solid, short Size:12.5cm	01-2199 No.3 Size:15.5cm with round hollow handle	01-2200 No. 3 Straight Solid, Round Size:14.5cm	01-2201 No. 3 Angled Solid, Round Size:14cm
---	---	--	---	---	---	--	--	---	--

Razors & Dermatomes

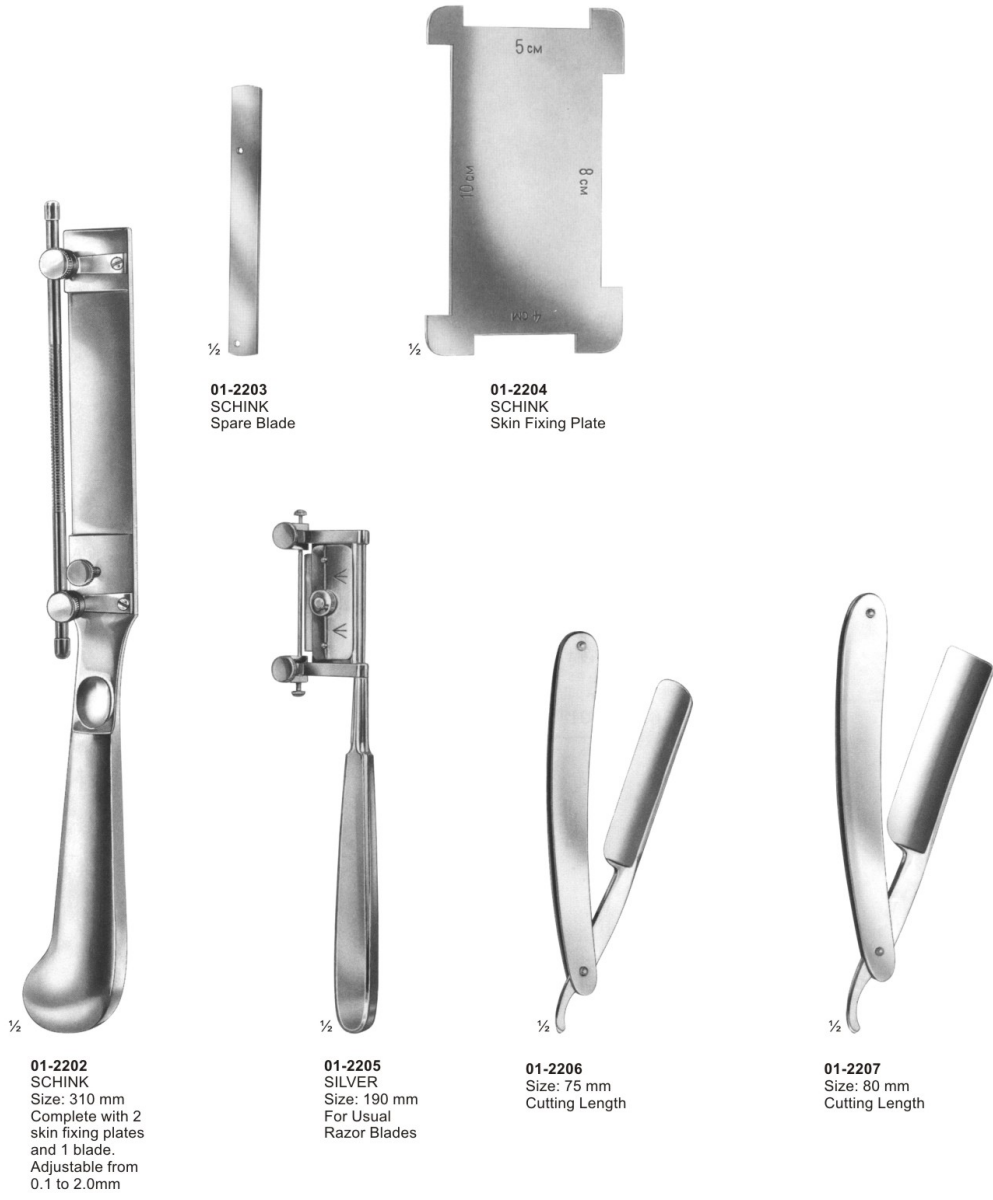

01-2203
SCHINK
Spare Blade

01-2204
SCHINK
Skin Fixing Plate

01-2202
SCHINK
Size: 310 mm
Complete with 2
skin fixing plates
and 1 blade.
Adjustable from
0.1 to 2.0mm

01-2205
SILVER
Size: 190 mm
For Usual
Razor Blades

01-2206
Size: 75 mm
Cutting Length

01-2207
Size: 80 mm
Cutting Length

Micro Scissors, "Spring Type" Flat Handles

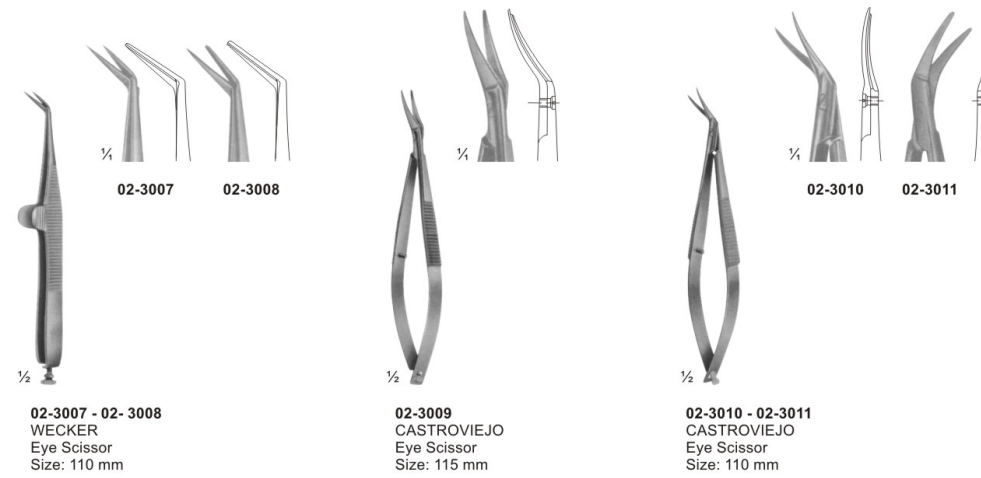
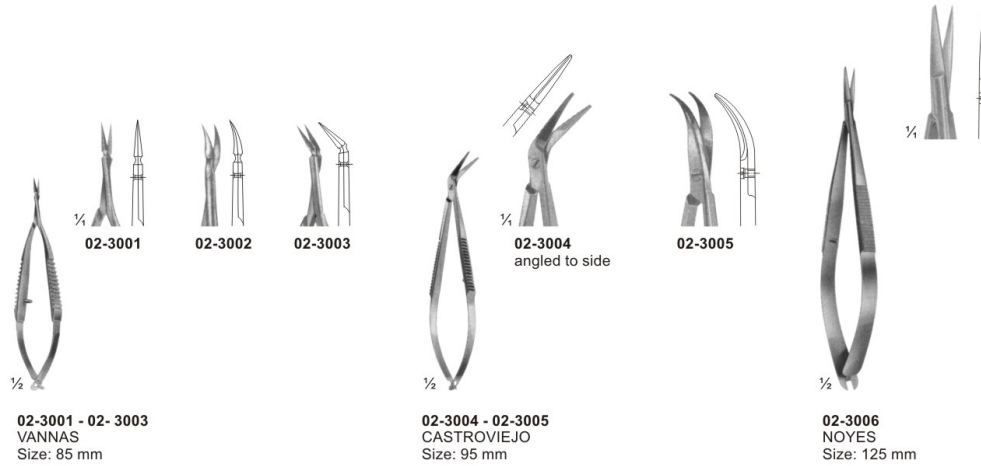

**Micro Scissors, "Spring Type" Flat Handles
and Cross-Serration**

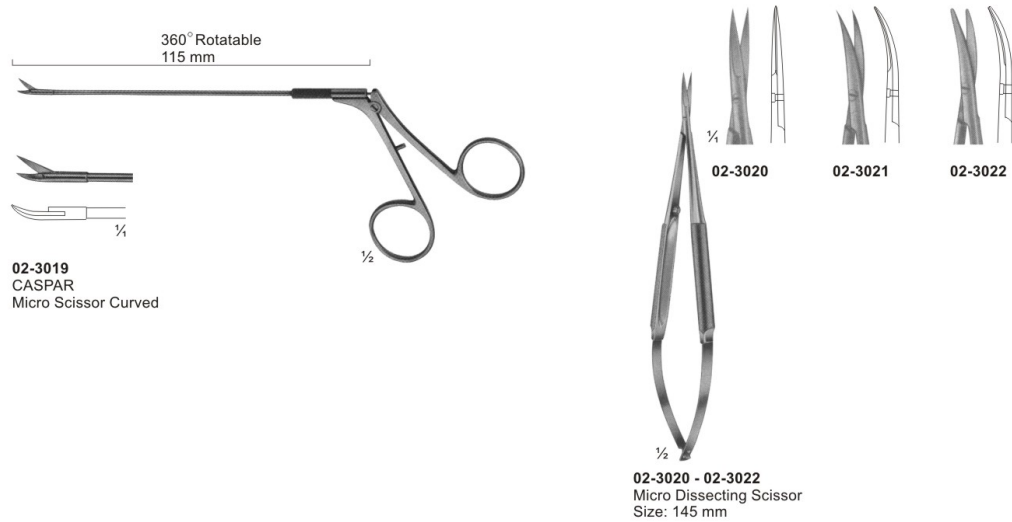
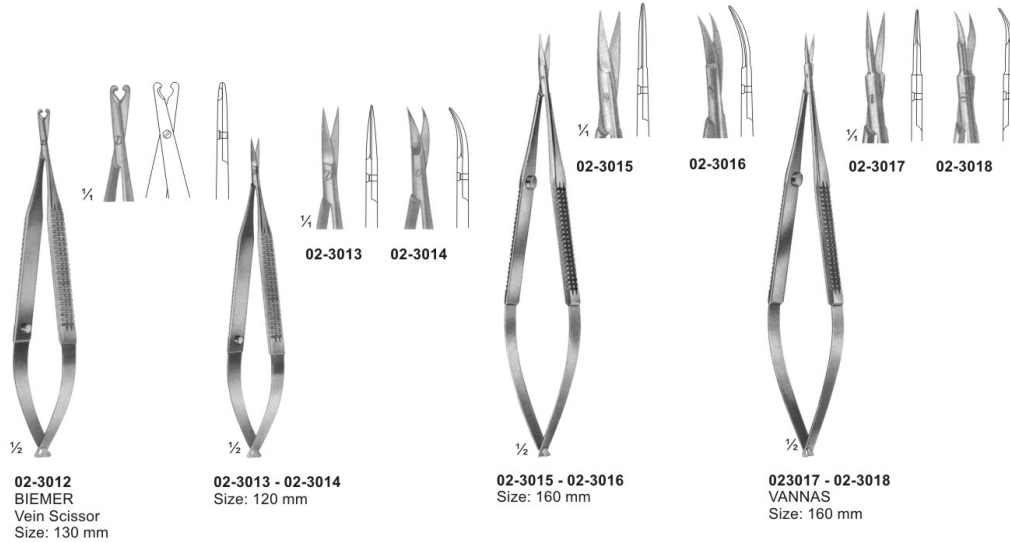

Micro Scissors, "Spring Type" Bayonet Shape



02-3023
YASARGIL
Size: 245 mm



02-3024
45°
Nagel



02-3025
45°



02-3024 - 02-3025
Laterally Angled
Size: 200 mm



02-3026
Laterally Angled
Size: 190 mm

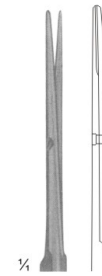

02-3027

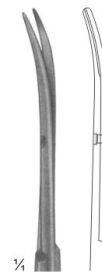

02-3028



02-3027 - 02-3028
YASARGIL
Size: 225 mm

Delicate Scissors

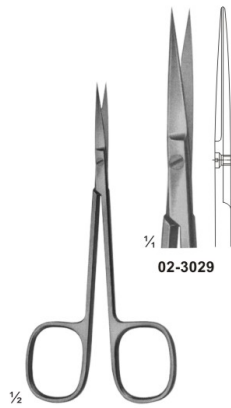

02-3029



02-3030

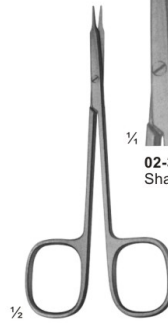

02-3031
Sharp

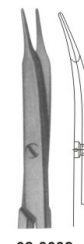

02-3032
Sharp



02-3033
Blunt



02-3034
Blunt

02-3029-02-3030
Size: 120 mm

02-3031 - 02-3034
STEVENS
Dissecting Scissors
Size: 115 mm

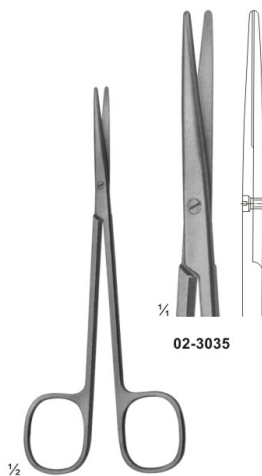

02-3035

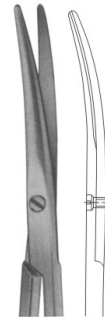

02-3036



02-3037
RAGNELL
Size: 135 mm



02-3038
RAGNELL
Size: 135 mm

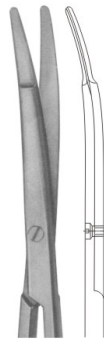

02-3039
Size: 150 mm

02-3035 - 02-3036
METZENBAUM
Dissecting Scissors
Size: 145 mm

02-3037 - 02-3039
Special flat points for
dissecting and
undermining the skin

Delicate Scissors

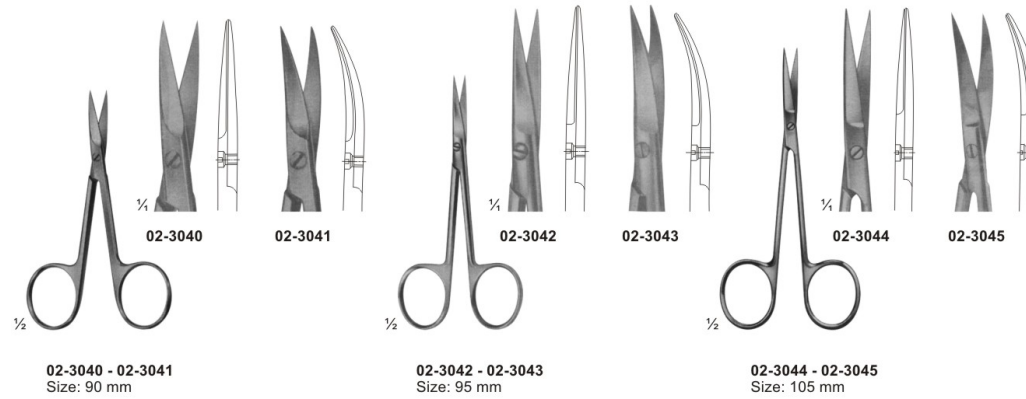

Delicate Scissors



02-3050 - 02-3052
Size: 120 mm

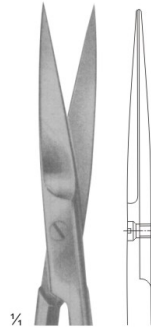

02-3050

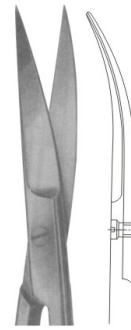

02-3051

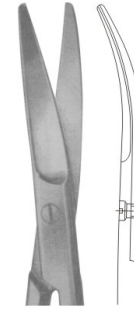

02-3052



02-3053 - 02-3056
Size: 130 mm

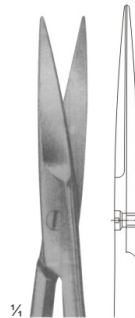

02-3053

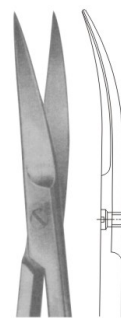

02-3054

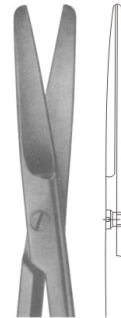

02-3055

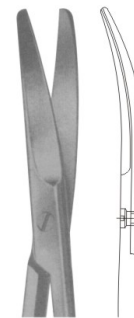

02-3056

Delicate Scissors

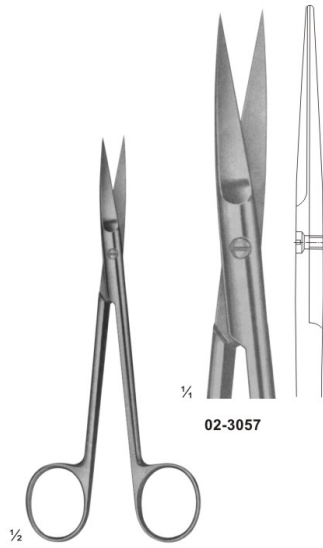

02-3057

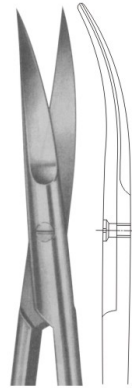

02-3058

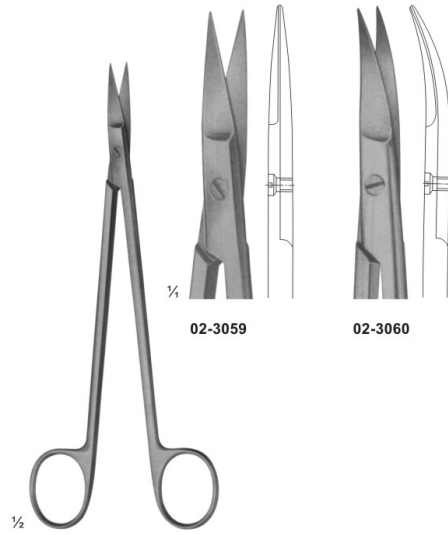

02-3059

02-3060

02-3057 - 02-3058
JOSEPH
Size: 150 mm

02-3059 - 02-3060
KELLY
Size: 175 mm

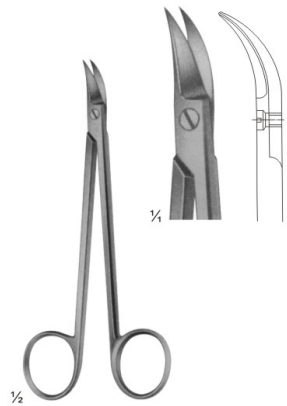

02-3061
QUINBY
Size: 130 mm

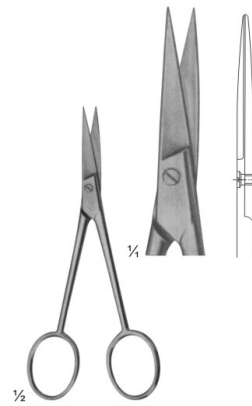

02-3062
Size: 110 mm

Surgical Scissors

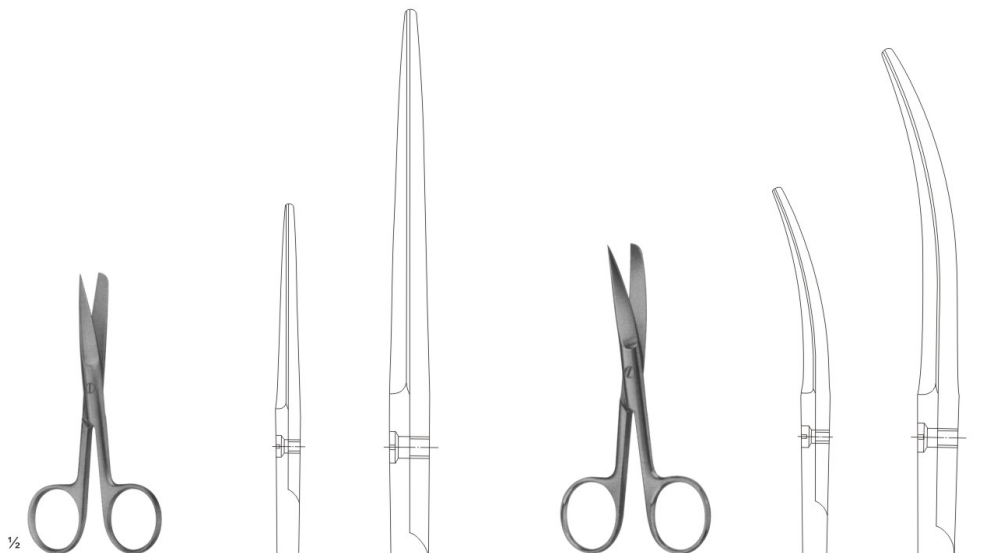

02-3063 - 02-3071 (Standard Types)
 02-3063 (105 mm)
 02-3064 (115 mm)
 02-3065 (130 mm)
 02-3066 (145 mm)
 02-3067 (150 mm)
 02-3068 (165 mm)
 02-3069 (175 mm)
 02-3070 (185 mm)
 02-3071 (200 mm)

02-3063
 Size: 105 mm

02-3071
 Size: 200 mm

02-3072 - 02-3078 (Standard Types)
 02-3072(115 mm)
 02-3073 (130 mm)
 02-3074 (145 mm)
 02-3075 (150 mm)
 02-3076 (165 mm)
 02-3077 (175 mm)
 02-3078(185 mm)

02-3072
 Size: 115 mm

02-3078
 Size: 185 mm



02-3079 - 02-3082
 Slender Types

02-3079 130 mm
02-3080 145 mm

02-3081 130 mm
02-3082 145 mm

02-3083 - 02-3084
 For Wound Edges
 1 Blade Serrated

02-3083
 130 mm

02-3084
 130 mm

Surgical Scissors



02-3085 - 02-3089 (Standard Types)
02-3085 (130 mm)
02-3086 (145 mm)
02-3087 (150 mm)
02-3088 (165 mm)
02-3089 (175 mm)

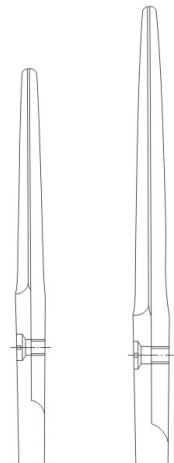

02-3085 **02-3089**
 Size: 130 mm Size: 175 mm



02-3090 - 02-3095 - COOPER
 Standard Types
02-3090 (115 mm)
02-3091 (130 mm)
02-3092 (145 mm)
02-3093 (150 mm)
02-3094 (165 mm)
02-3095 (175 mm)

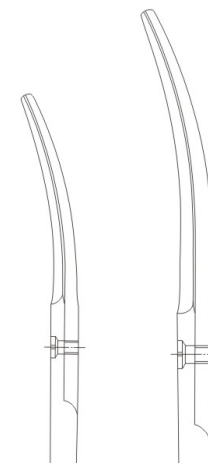

02-3090 **02-3095**
 Size: 115 mm Size: 175 mm



02-3096 - 02-3102A
 Standard Types
02-3096 (115 mm) **02-3100A** (115 mm)
02-3097 (130 mm) **02-3101** (130 mm)
02-3098 (145 mm) **02-3101A** (145 mm)
02-3099 (150 mm) **02-3102** (150 mm)
02-3100 (165 mm) **02-3102A** (165 mm)

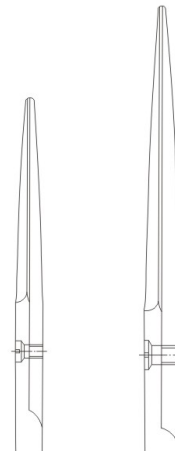

02-3096 **02-3100**
 Size: 115 mm Size: 165 mm

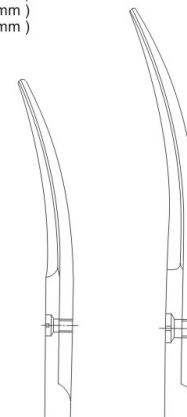

02-3100A **02-3102A**
 Size: 115 mm Size: 165 mm

Surgical Scissors

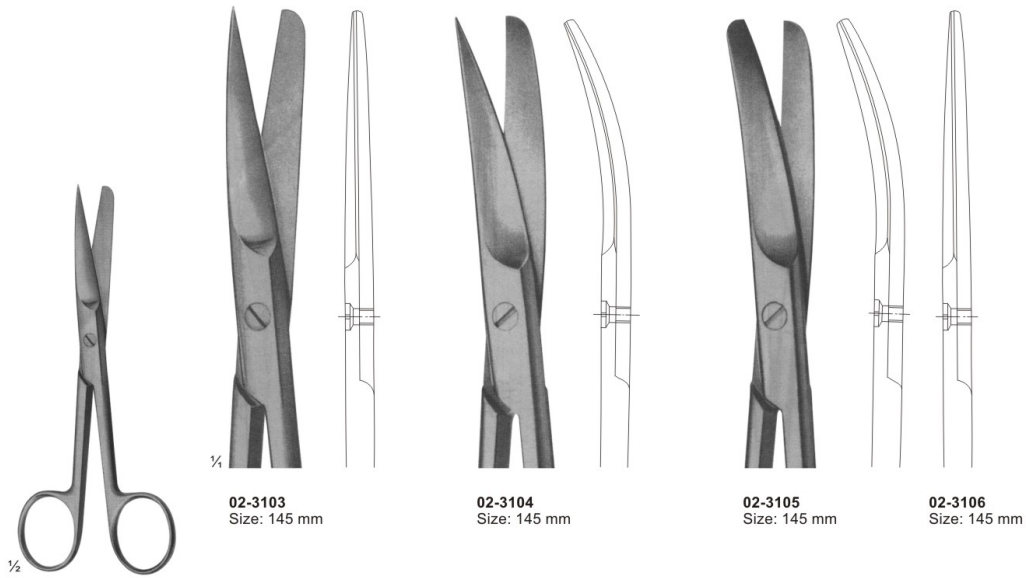

02-3103 - 02-3106
DEAVER
With flat lock

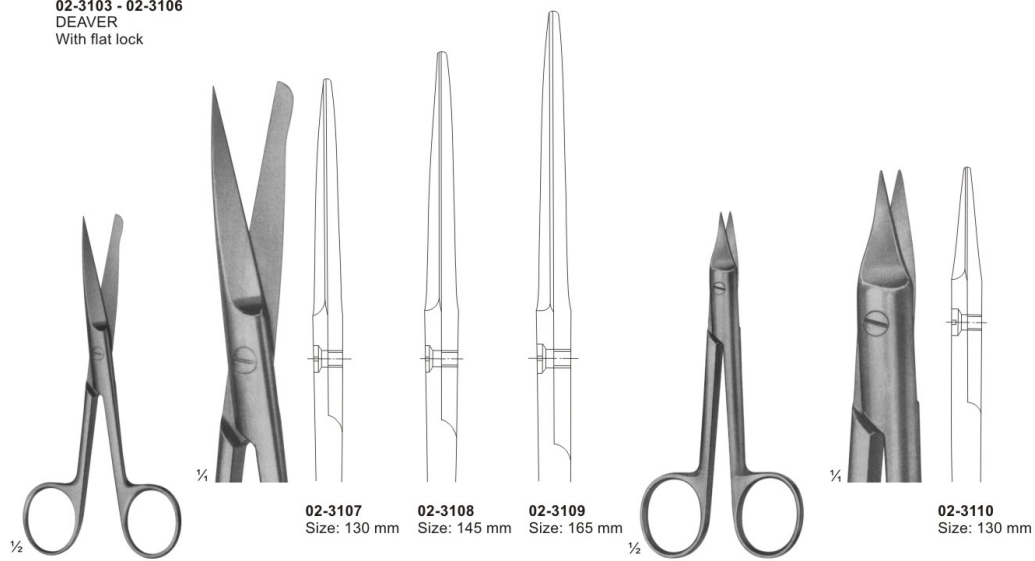

02-3107 - 02-3109
Incision Scissors

02-3110
SYSTRUNK
Nail Splitting Scissors

Dissecting Scissors

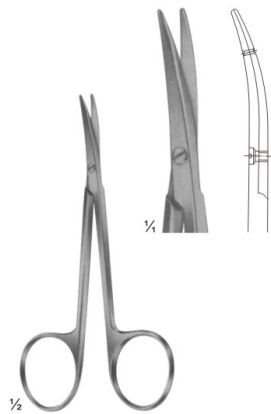

02-3111
LITTLER
Dissecting Scissors
Tips with eye for suture
Size: 115 mm

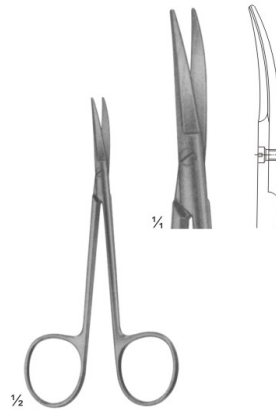

02-3112
COTTLE
Bulldog Scissors
Size: 115 mm

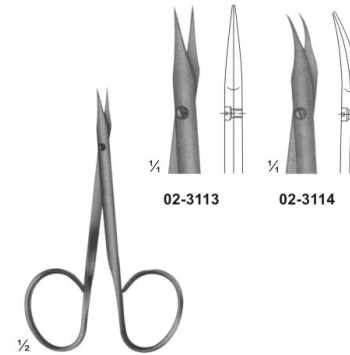

02-3113 - 02-3114
STEVENS
Vessel and tendon Scissors
Size: 100 mm

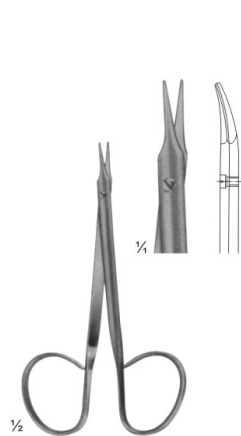

02-3115
STEVENS
Fine Dissecting Scissors
Size: 110 mm

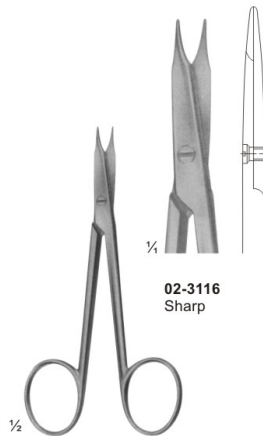

02-3116 - 02-3119
STEVENS
Vessel and tendon Scissors
Size: 110 mm

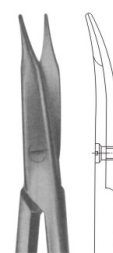

02-3117
Sharp

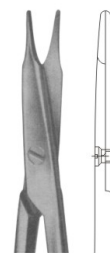

02-3118
Blunt

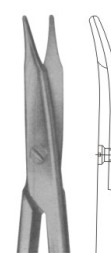

02-3119
Blunt

Dissecting Scissors

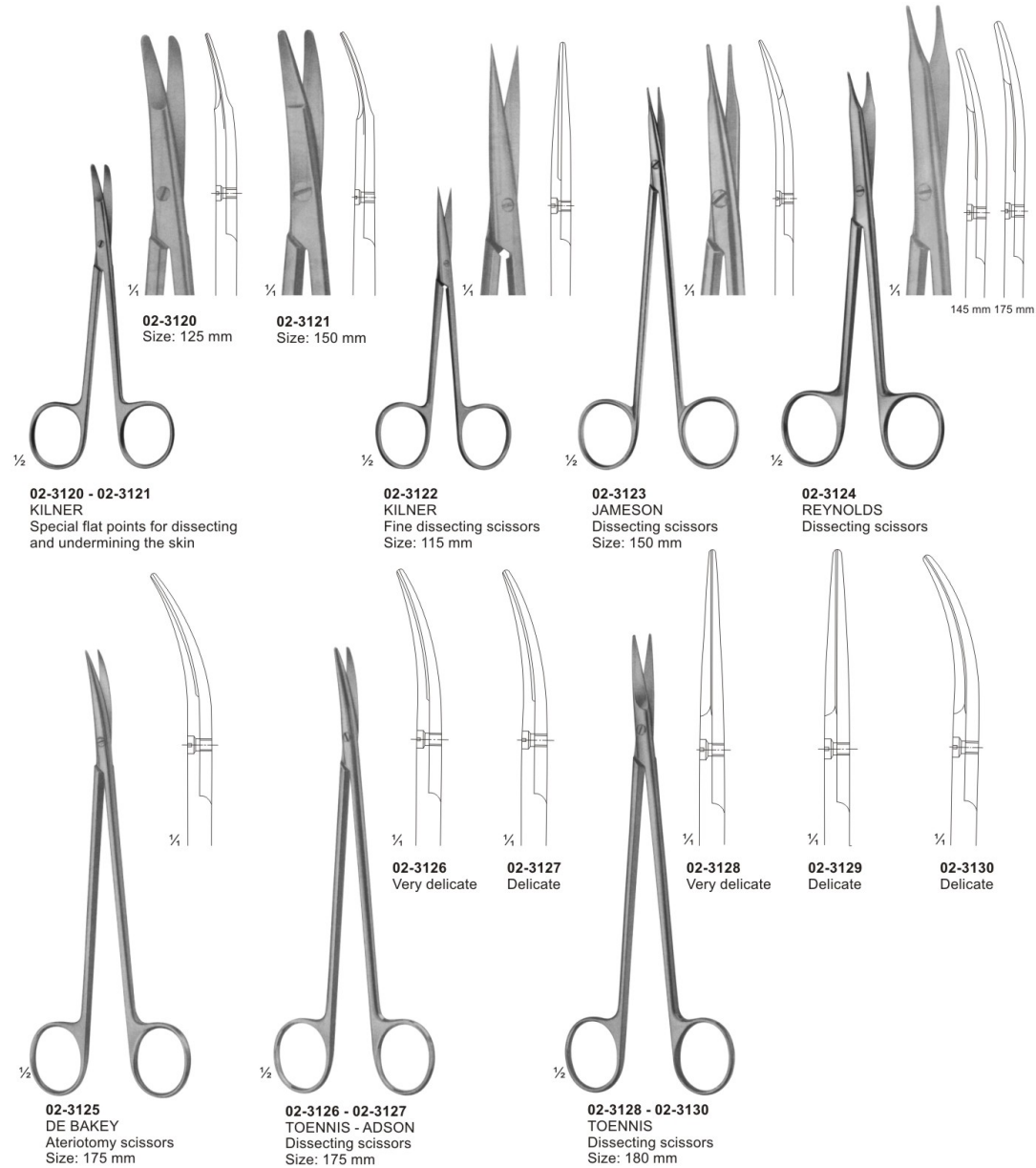

Dissecting & Surgical Scissors



02-3131
Size: 115 mm

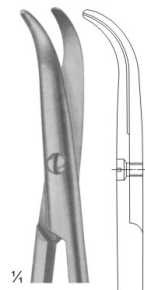

02-3132
Size: 135 mm

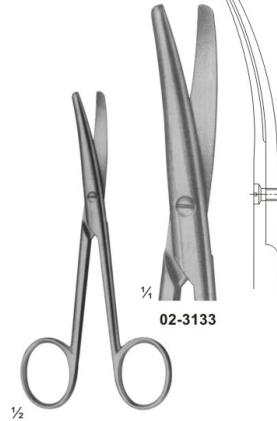

02-3133

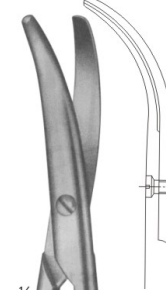

02-3134

02-3131 - 02-3132
FOMON
Lower lateral scissors

02-3133 - 02-3134
LANDOLT
Enucleation scissors
Size: 120 mm

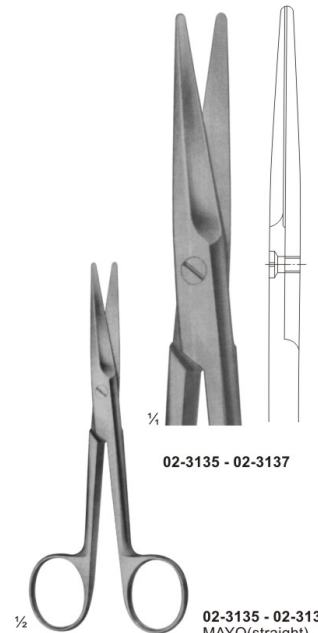

02-3135 - 02-3137

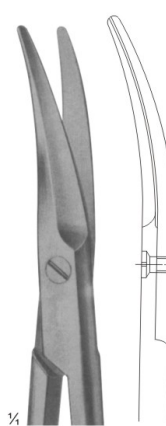

02-3138 - 02-3140
MAYO(curved)
02-3138 (140 mm)
02-3139 (155 mm)
02-3140 (170 mm)

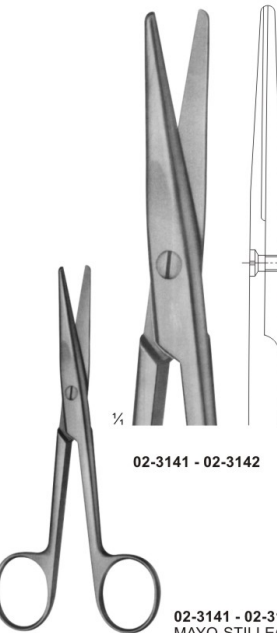

02-3141 - 02-3142

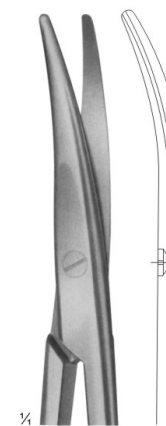

02-3143 - 02-3144
MAYO-STILLE(curved)
02-3143 (140 mm)
02-3144 (170 mm)

02-3135 - 02-3137
MAYO(straight)
02-3135 (140 mm)
02-3136 (155 mm)
02-3137 (170 mm)

02-3141 - 02-3142
MAYO-STILLE(straight)
02-3141 (140 mm)
02-3142 (170 mm)

Dissecting Scissors

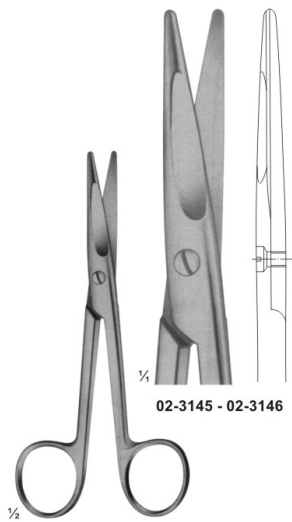

02-3145 - 02-3146
MAYO-STILLE
With chamfered blades
02-3145 (140 mm)
02-3146 (170 mm)

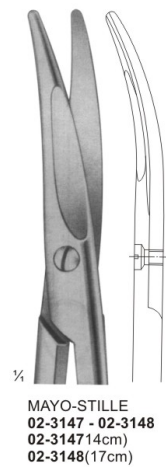

MAYO-STILLE
02-3147 - 02-3148
02-3147 (14cm)
02-3148 (17cm)

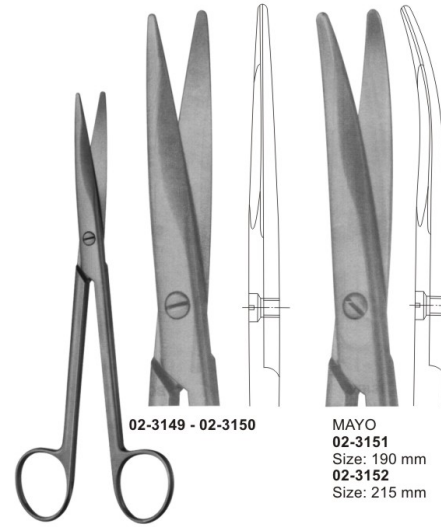

MAYO
With chamfered blades
02-3149 (190 mm)
02-3150 (215 mm)

MAYO
02-3151
Size: 190 mm
02-3152
Size: 215 mm

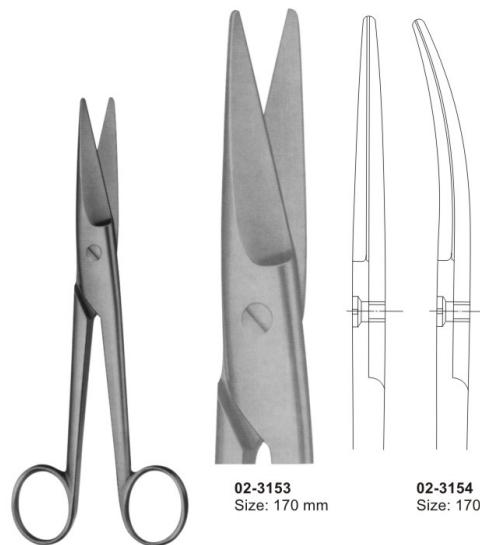

02-3153 - 02-3154
MAYO-NOBLE (Broad pattern)

02-3153
Size: 170 mm

02-3154
Size: 170 mm

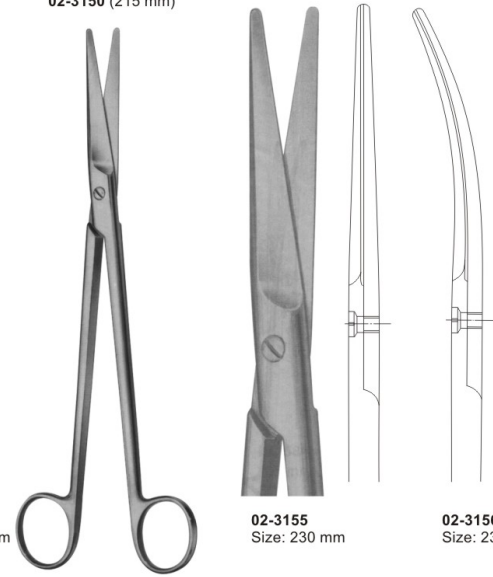

02-3155 - 02-3156
MAYO-HARRINGTON

02-3155
Size: 230 mm

02-3156
Size: 230 mm

Dissecting Scissors

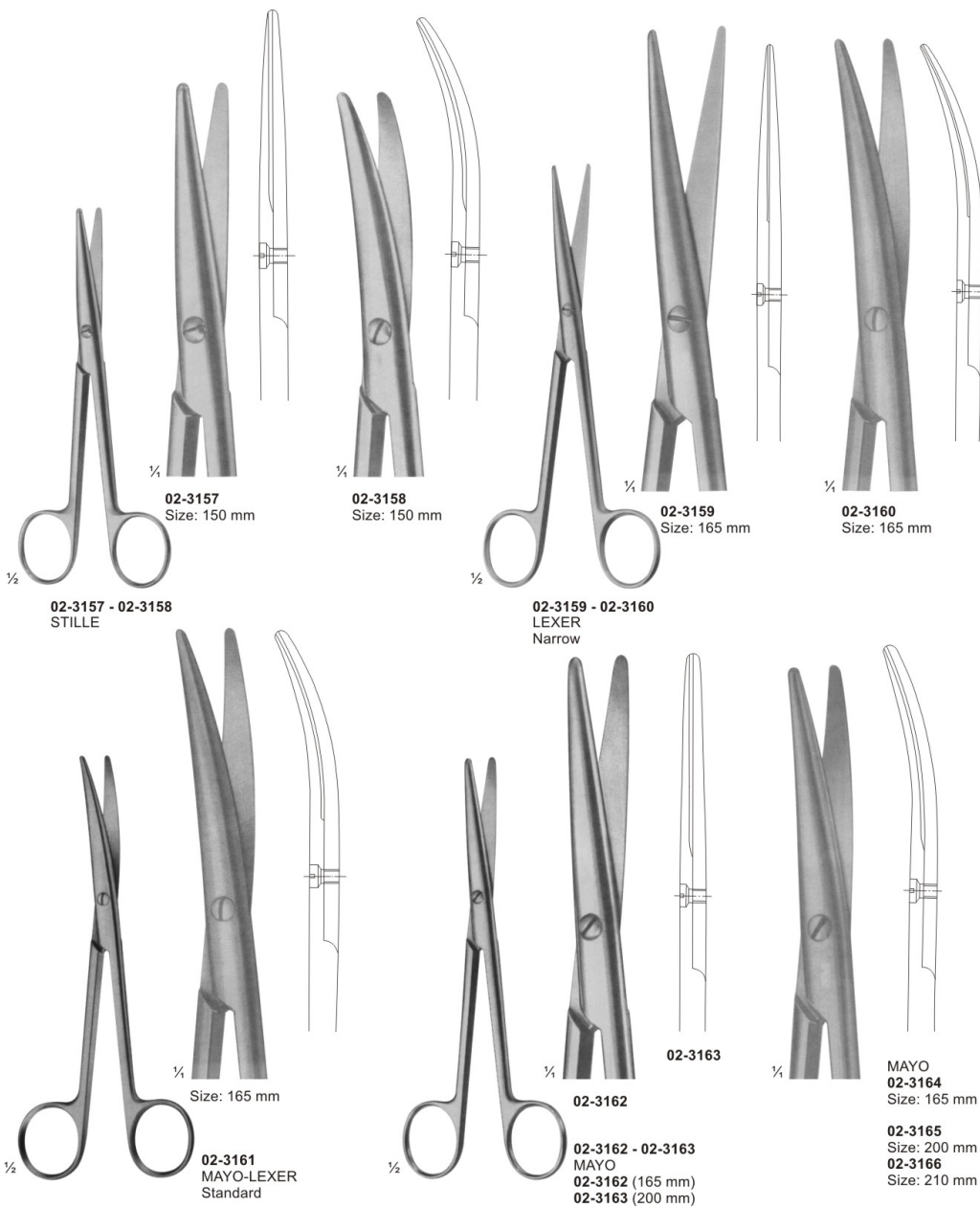

Dissecting Scissors

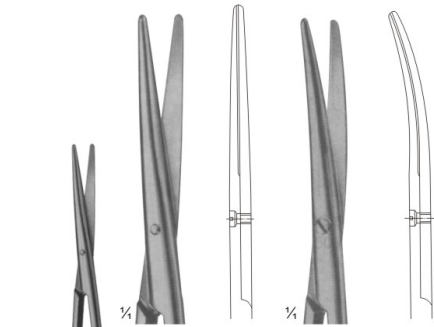

02-3167
Size: 145 mm

02-3168
Size: 145 mm

$\frac{1}{2}$
02-3167 - 02-3168
BABY - METZENBAUM

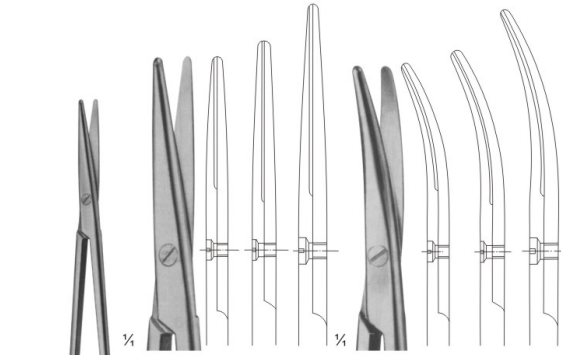

02-3169 145 mm
02-3170 180 mm
02-3171 200 mm
02-3172 145 mm
02-3173 180 mm
02-3174 200 mm

$\frac{1}{2}$
02-3169 - 02-3174
METZENBAUM

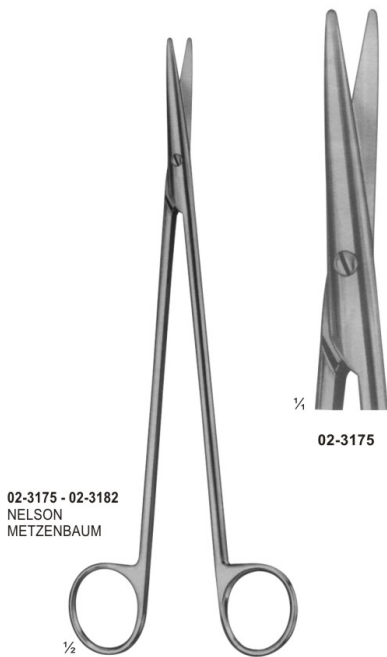

$\frac{1}{4}$
02-3175

$\frac{1}{4}$
02-3179

$\frac{1}{2}$
02-3175 - 02-3182
NELSON
METZENBAUM

02-3175 230 mm
02-3176 250 mm
02-3177 280 mm
02-3178 305 mm

02-3179 230 mm
02-3180 250 mm
02-3181 280 mm
02-3182 305 mm

Vessel Scissors

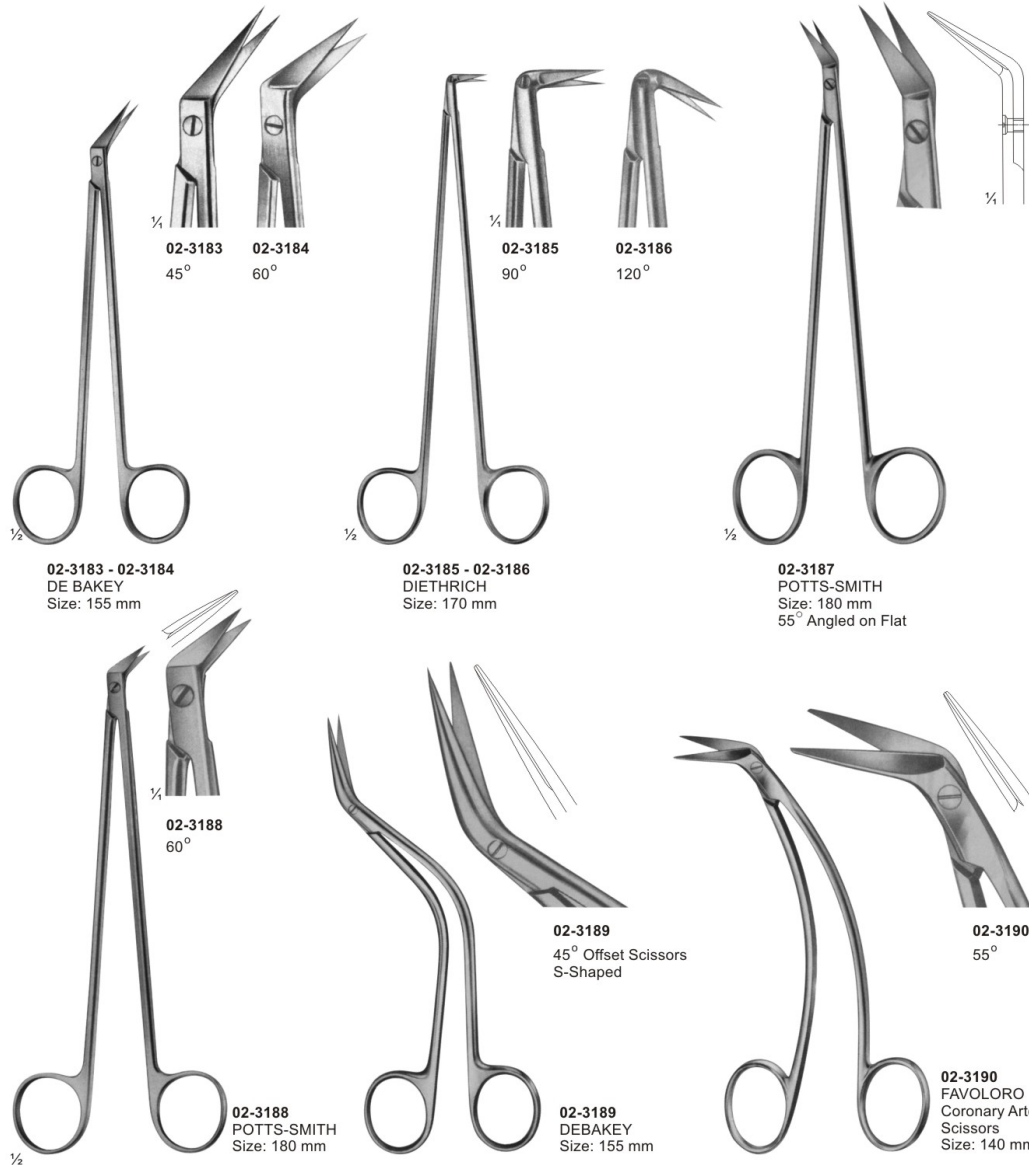

Cardiovascular and Neuro-Surgery Scissors

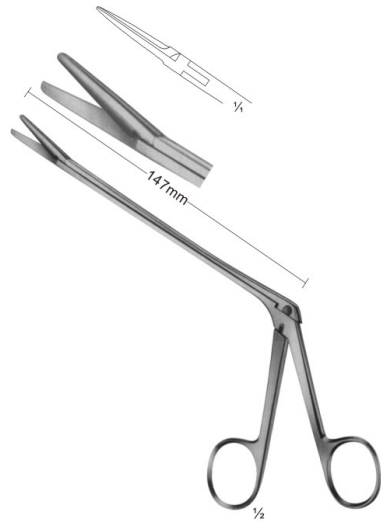

02-3191
OLIVECRONA
Dura Scissors



02-3192
STRULLY
Pointed
Size: 220 mm

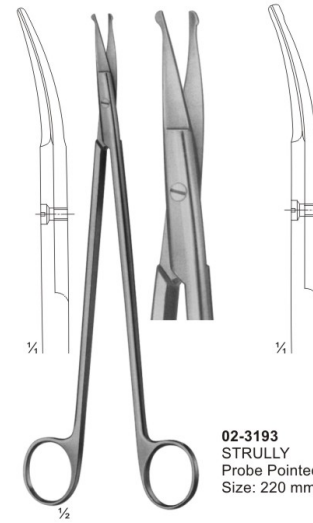

02-3193
STRULLY
Probe Pointed
Size: 220 mm

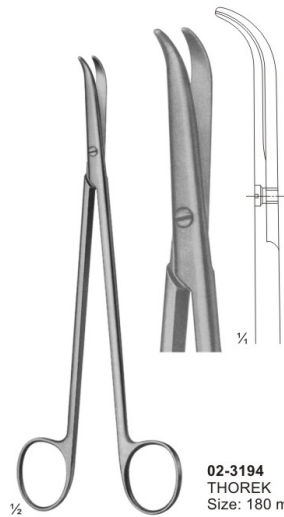

02-3194
THOREK
Size: 180 mm

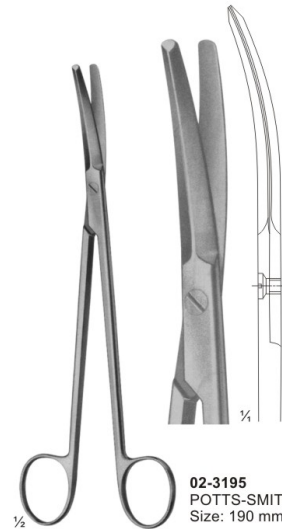

02-3195
POTTS-SMITH
Size: 190 mm

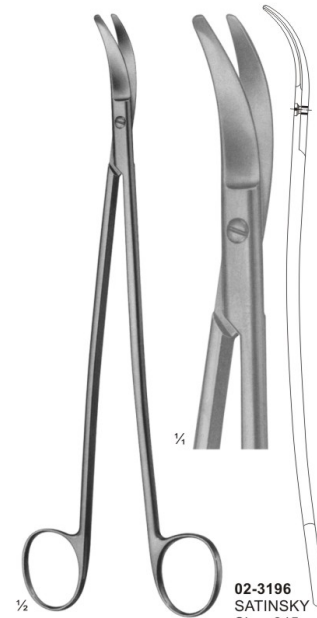

02-3196
SATINSKY
Size: 245 mm

Delicate, Nasal and Tonsil Scissors



02-3197
1 Finely Toothed Blade
Size: 130 mm

02-3198
LOCKLIN
Curved Sideways,
1 Toothed Blade
Size: 155 mm

02-3199
FOMON
Blades Serrated
Size: 145 mm

02-3200
COTTLE
Size: 165 mm



02-3201
HEYMANN-KNIGHT
Size: 175 mm

02-3202
DEAN
Blades Serrated
Size: 170 mm

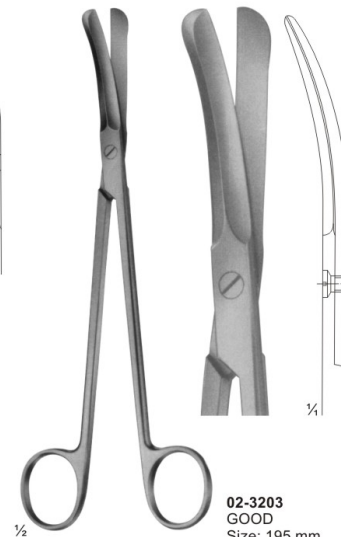

02-3203
GOOD
Size: 195 mm

Bone Shears



02-3204
KILLIAN
Size: 200 mm



02-3205 - 02-3206

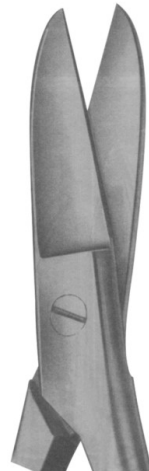

02-3205
195 mm



02-3206
225 mm



Operating and Gynaecology Scissors

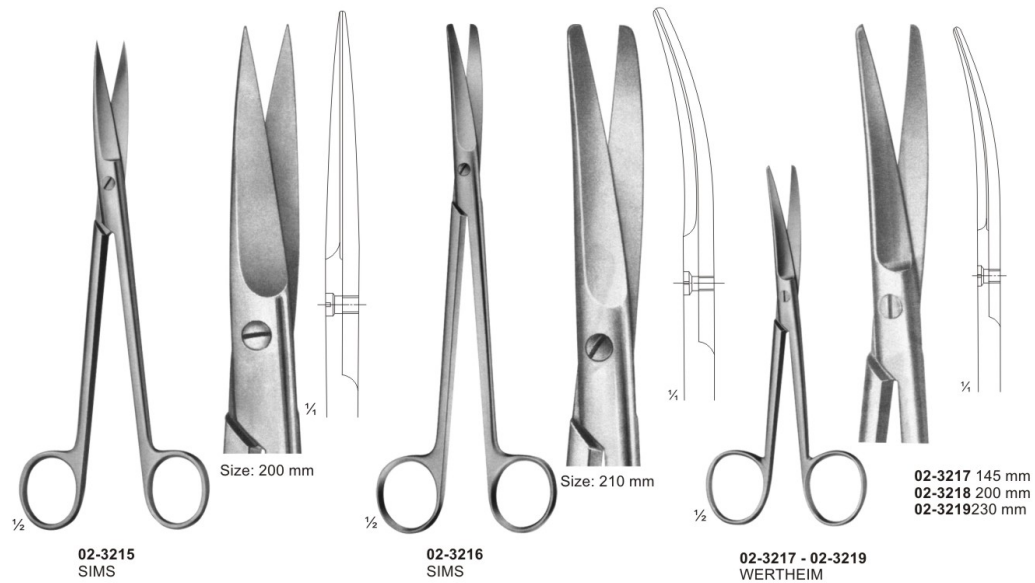
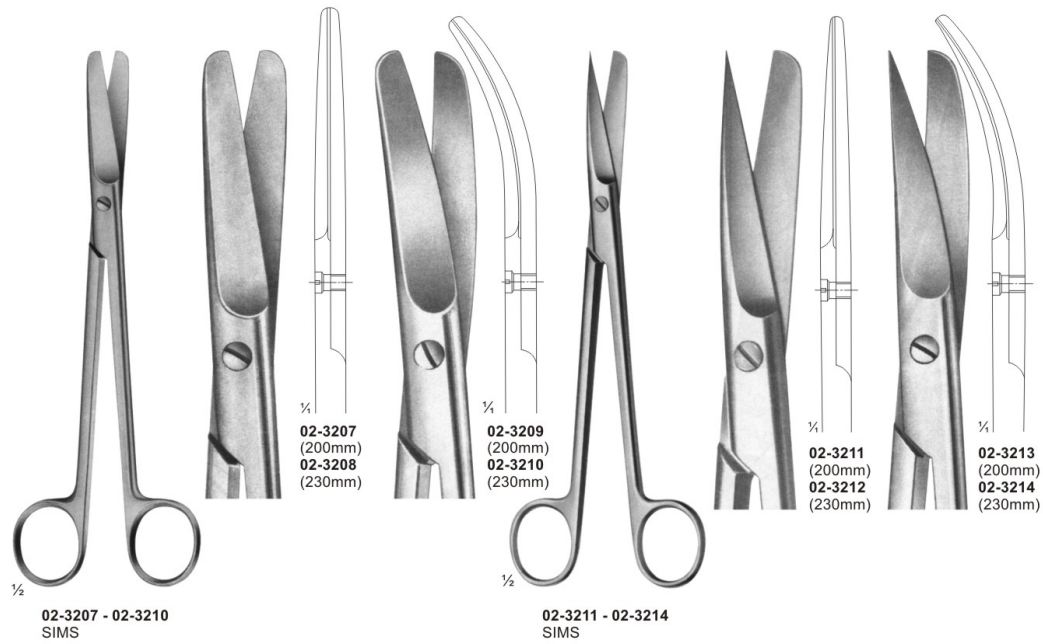

Operating and Gynaecology Scissors



02-3220
SIEBOLD
Uterine Scissors
Size: 245 mm

02-3221
BOZEMANN
Uterine Scissors
Size: 220 mm

02-3222
SIMS-SIEBOLD
Uterine Scissors
Size: 250 mm

Scissors For Obstetrics



02-3223
SCHUMACHER
Umbilical Cord Scissors
Size: 155 mm

02-3224
Umbilical Cord Scissors
Size: 105 mm

02-3225
Umbilical Cord Scissors

$\frac{1}{4}$
135 mm

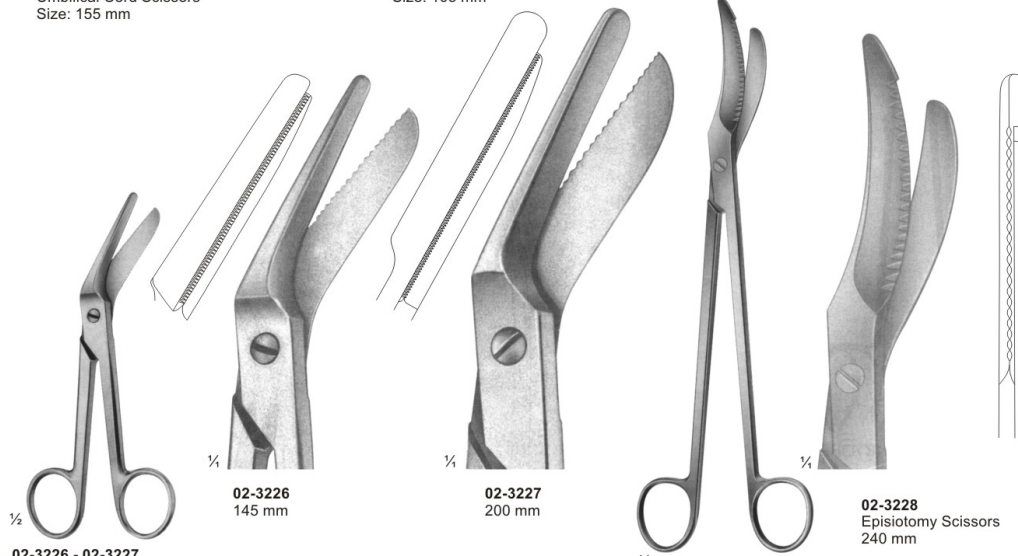

02-3226 - 02-3227
BRAUN-STADLER
Episiotomy Scissors

02-3226
145 mm

02-3227
200 mm

02-3228
Episiotomy Scissors
240 mm

Bowel Scissors, Rectal Scissors

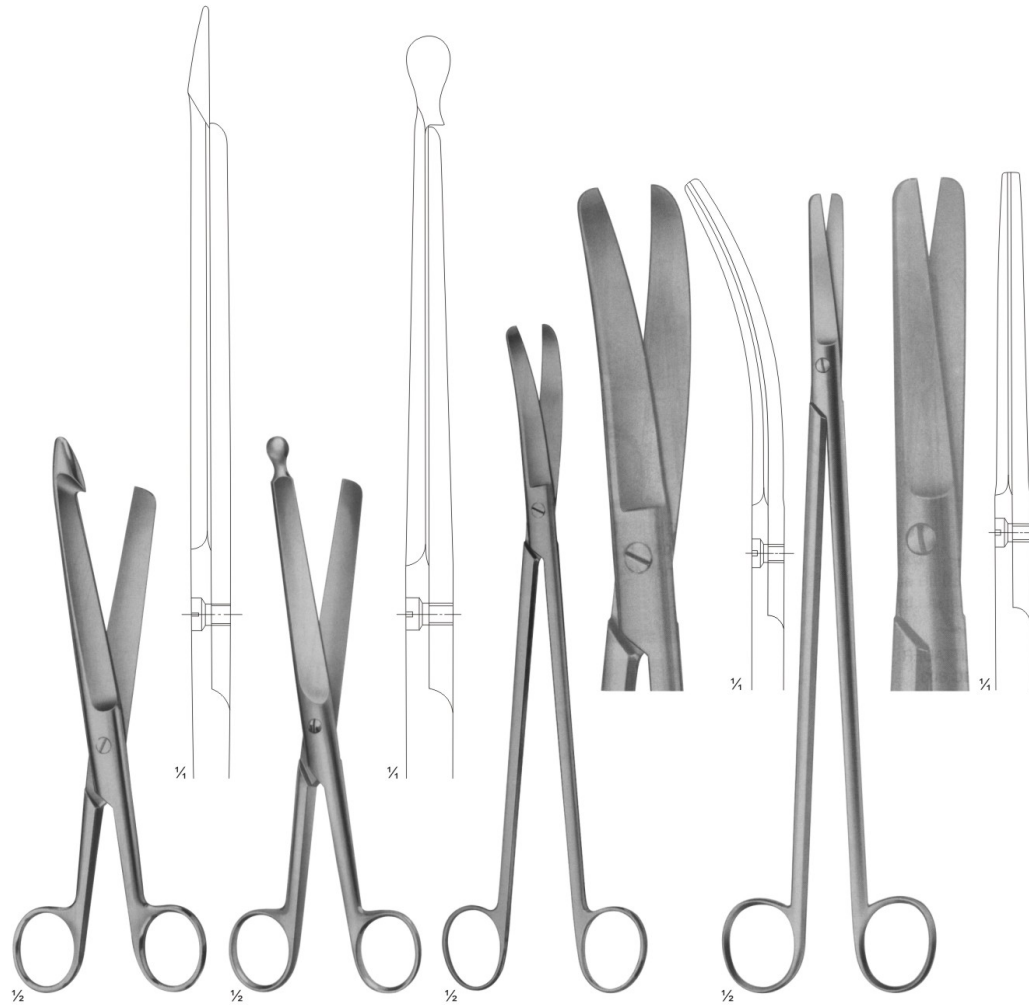

02-3229
Bowel Scissors
Size: 210 mm

02-3230
Bowel Scissors
Size: 210 mm

02-3231
LLOYD-DAVIES
(GOLIGHER'S)
Rectal Scissors
Size: 270 mm

02-3232
STELZNER
Rectal Scissors
Size: 310 mm

Ligature Scissors



02-3233 - 02-3234
SPENCER

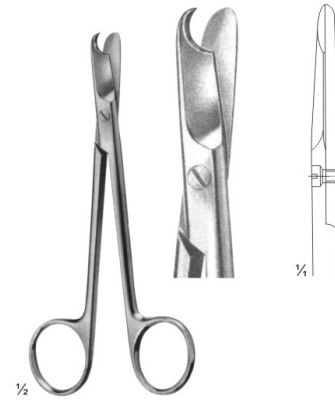

02-3235
LITTAUER
Size: 135 mm

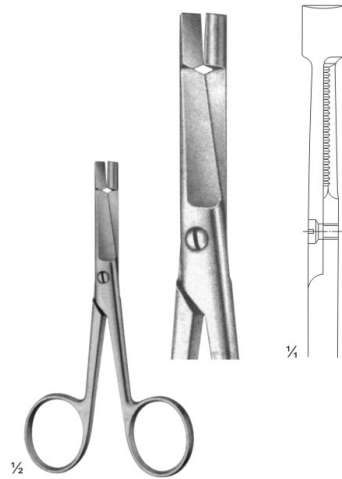

02-3236
EISELSBERG
Size: 115 mm

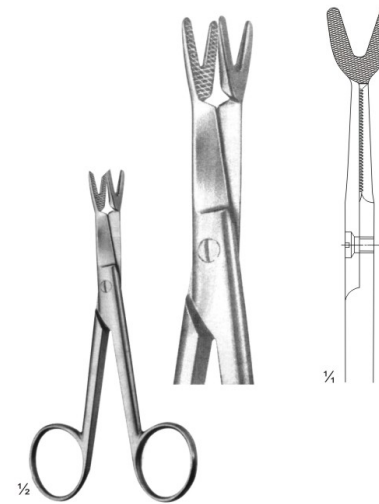

02-3237
SCHOEMAKER-LOTH
Size: 125 mm

Wire and Plate Scissors

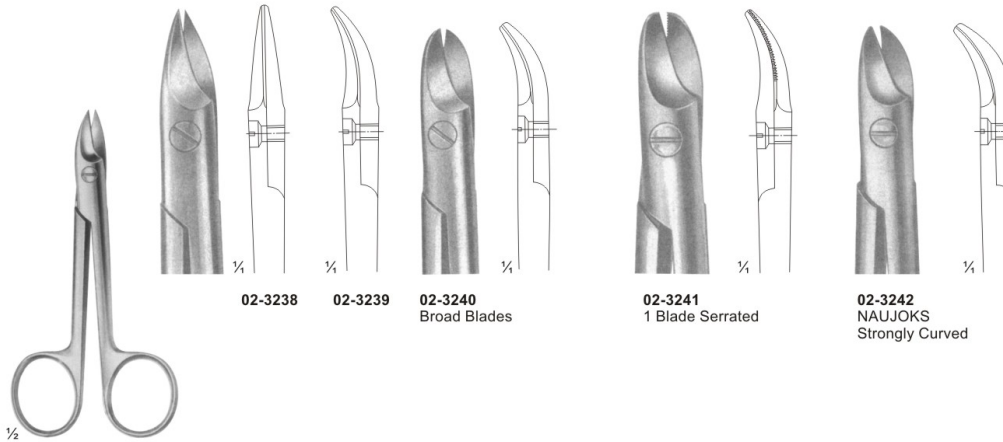

02-3238 - 02-3242
BEEBE
Size: 110 mm

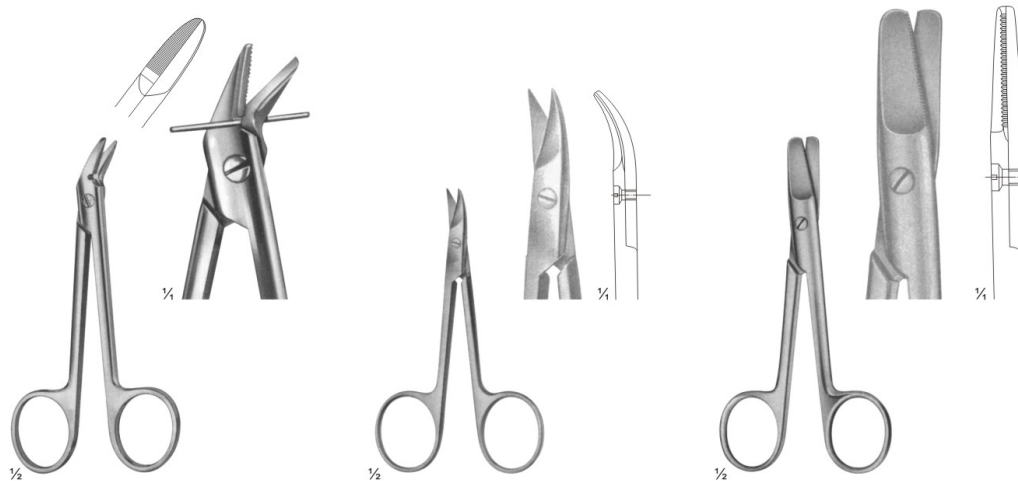

02-3243
1 Blade Serrated
Size: 120 mm

02-3244
STRACK
Size: 100 mm

02-3245
HARVEY
blades serrated
Size: 125 mm

Nail and Bandage Scissors

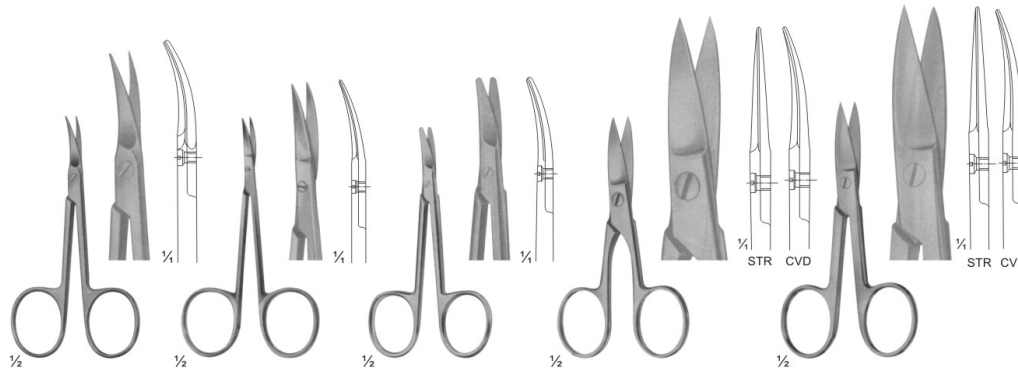

02-3246
NAIL SCISSORS
Size: 90 mm

02-3247
NAIL SCISSORS
especially fine pattern
Size: 90 mm

02-3248
BABY NAIL
SCISSORS
Size: 85 mm

02-3249 - 02-3252
NAIL SCISSORS
02-3249(90mm)straight
02-3250(90mm)curved
02-3251(100mm)straight
02-3252(110mm)curved

02-3253 - 02-3255
NAIL SCISSORS
02-3253(95mm)straight
02-3254(95mm)curved
02-3255(105mm)straight



02-3256
KNOWLES
Size: 140 mm

02-3257
KNOWLES
Size: 145 mm

02-3258
Size: 150 mm

02-3259
SMITH
Size: 180 mm

02-3260
BANDAGE CUTTING
SCISSORS
Size: 310 mm

Bandage and Cloth Scissors



½
02-3261
UNIVERSAL BANDAGE & CLOTH SCISSORS,
WITH TOOTHED EDGES, AUTO CLEAVABLE up to 143 °C
180 mm

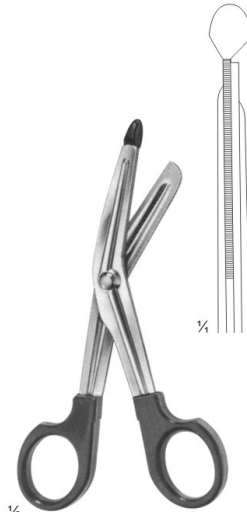

½
02-3262
LISTER BANDAGE & CLOTH
SCISSORS, WITH TOOTHED EDGES,
AUTO CLEAVABLE up to 143 °C
Size: 145 mm



½
02-3263
NURSE'S SCISSORS
Size: 145 mm
AUTO CLEAVABLE up to 143 °C

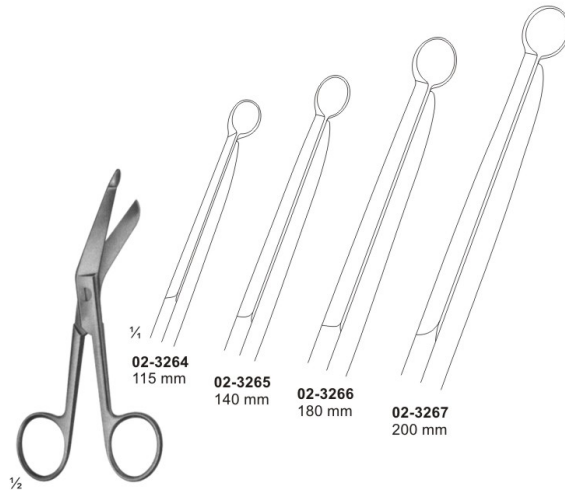

½
02-3264 - 02-3267
LISTER

02-3264
115 mm

02-3265
140 mm

02-3266
180 mm

02-3267
200 mm

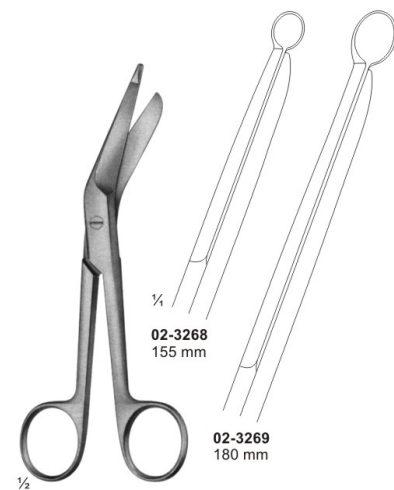

½
02-3268 - 02-3269
LISTER

02-3268
155 mm

02-3269
180 mm

Bandage, Cloth and Plaster Scissors



02-3270
CLOTH SCISSORS
205 mm

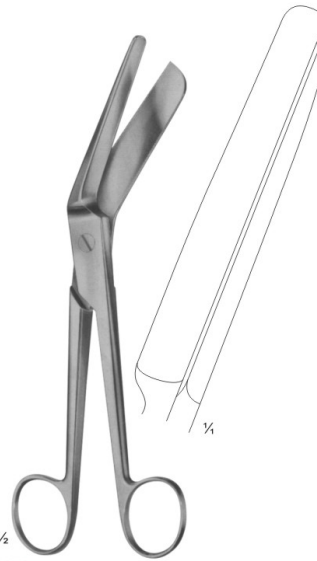

02-3271
BRAUN-STADLER
Bandage scissors
225 mm



02-3272
SEUTIN
Plaster scissors
230 mm

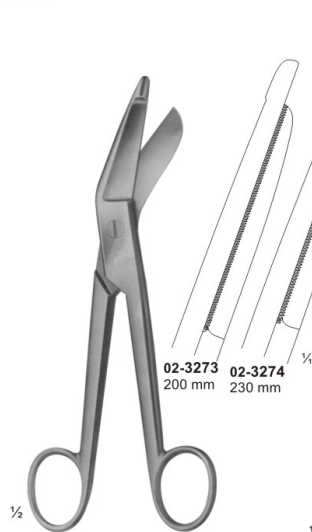

02-3273 - 02-3274
ESMARCH (Plaster scissors)

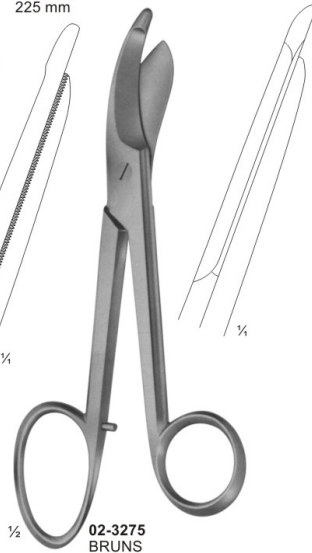

02-3275
BRUNS
Plaster scissors
235 mm

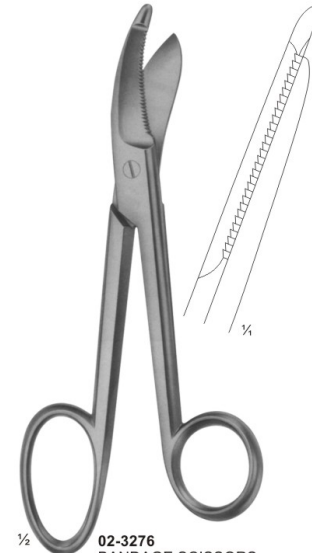

02-3276
BANDAGE SCISSORS
235 mm

Micro Forceps, Jeweler Types and Micro Suture Tying Forceps

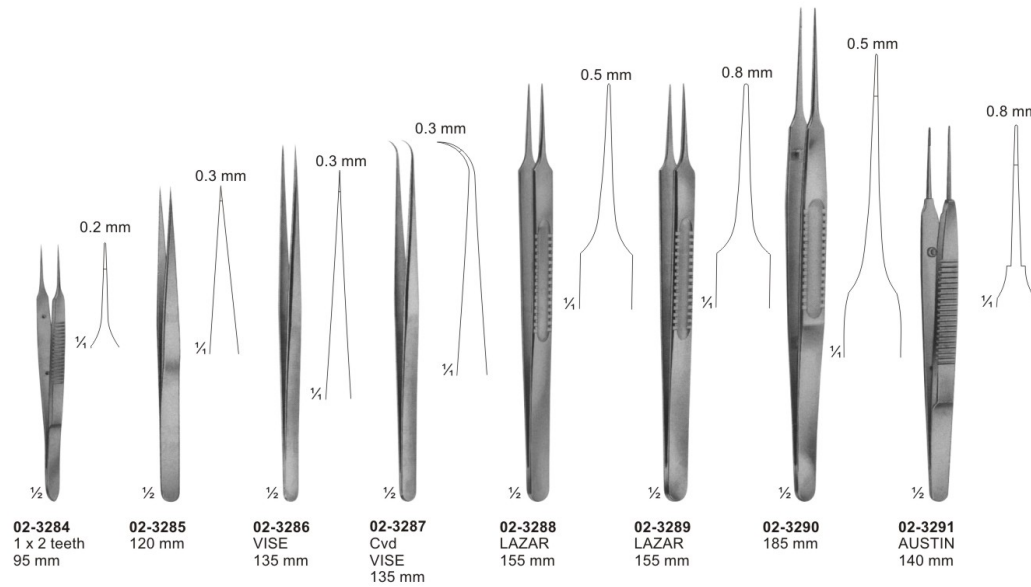
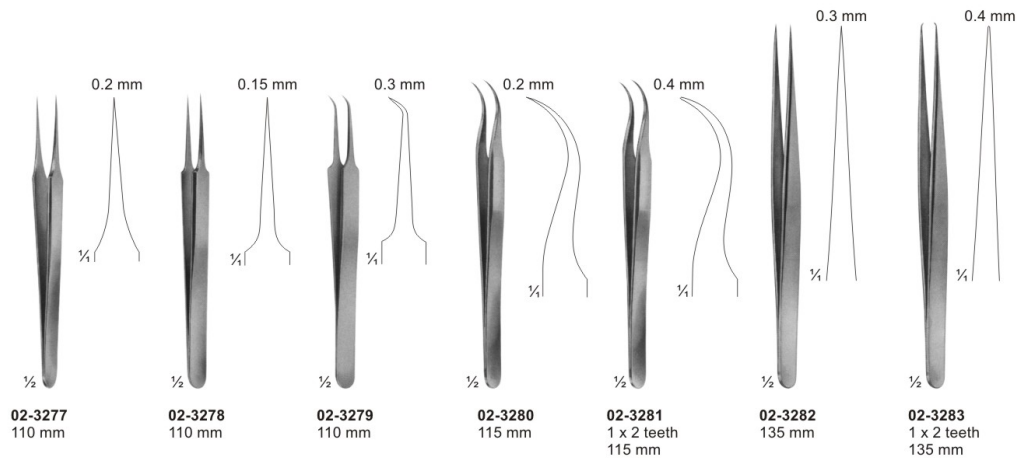

**Micro Forceps, Ligature Forceps (Light Patterns)
Bayonet - Shaped**

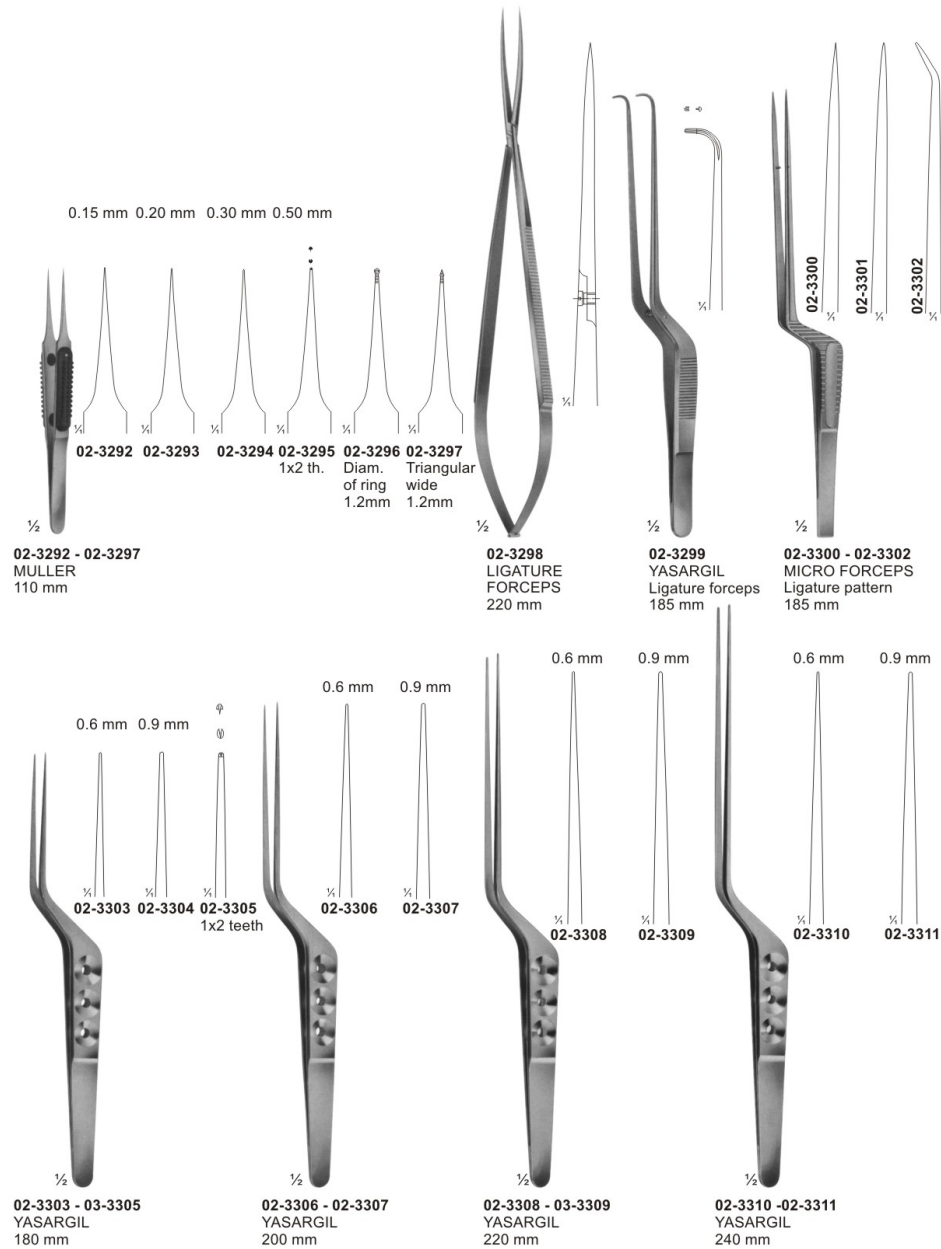

**Forceps for Grasping Tissue, Tumors,
Bayonet Shaped**

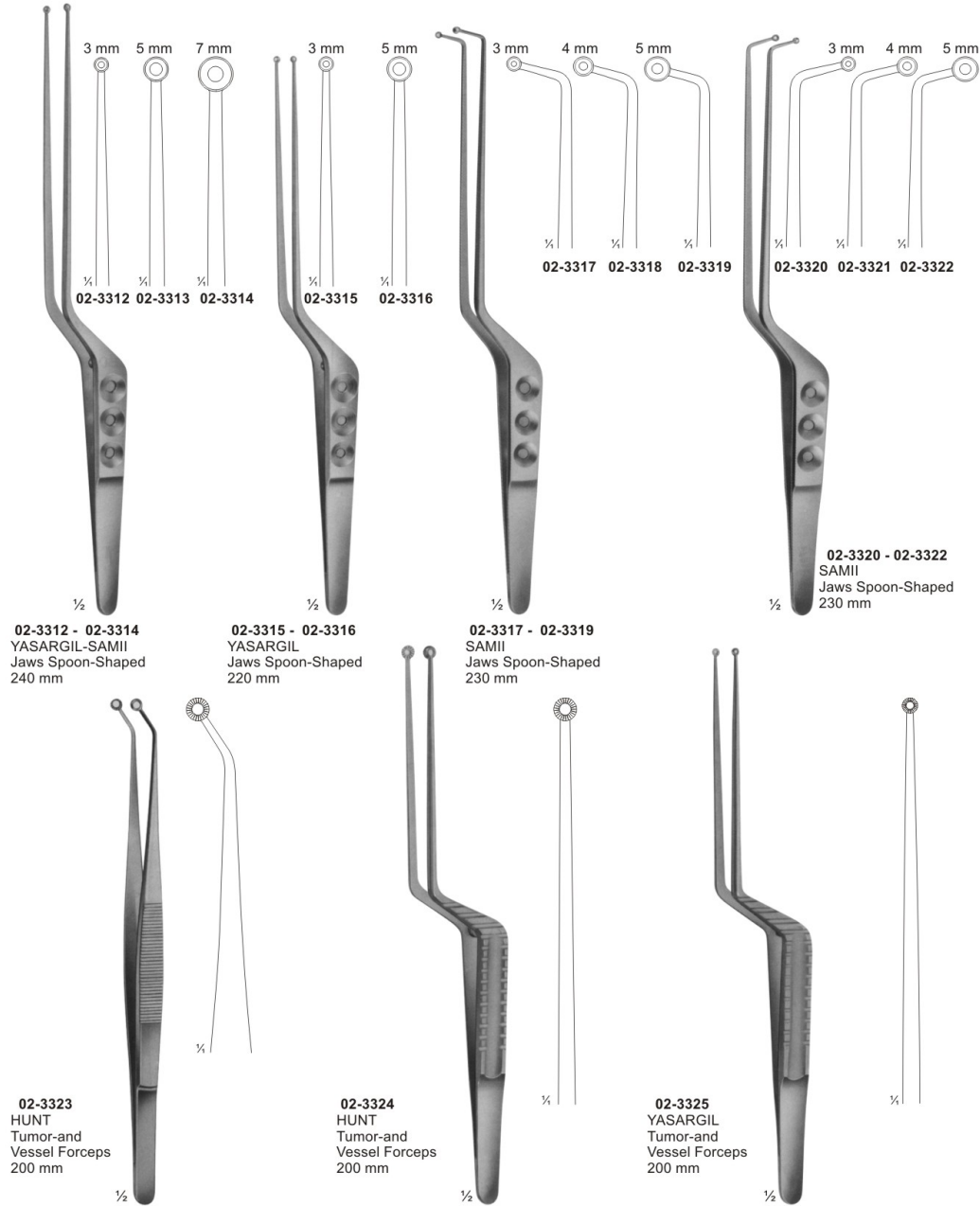

**Delicate Dissecting, Microscopic,
Sterilizing Forceps**

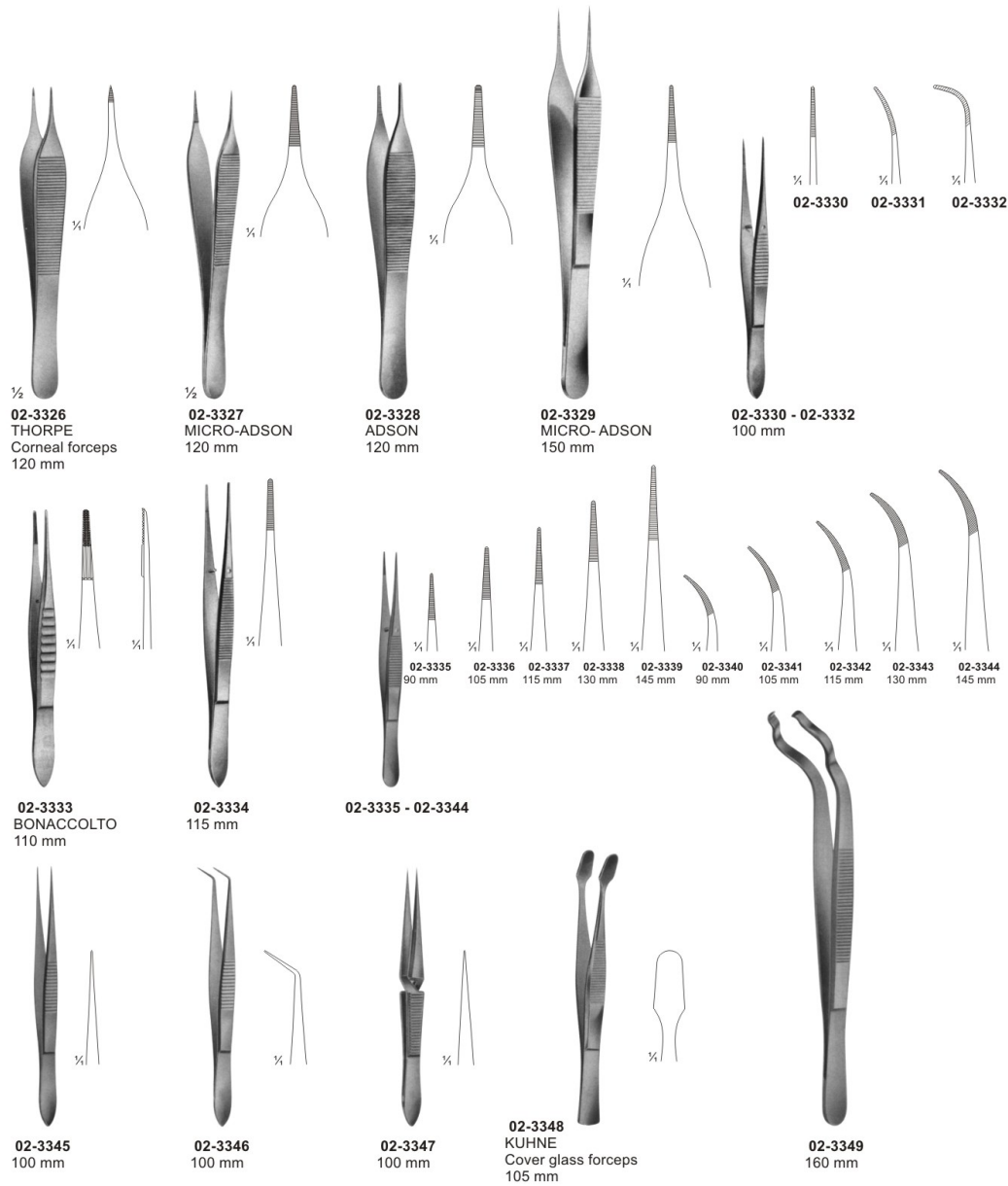

Delicate Dissecting Forceps

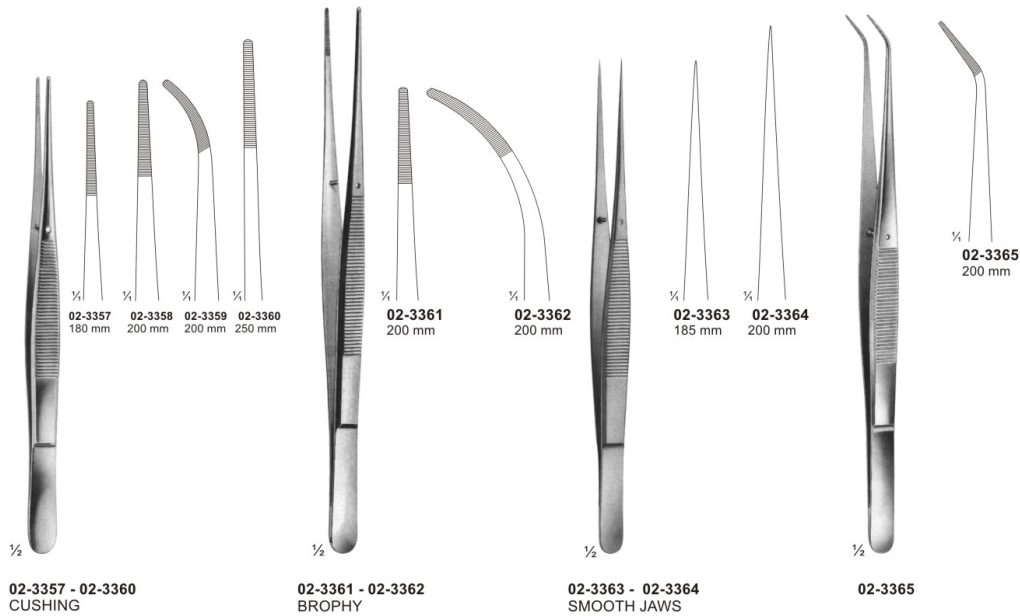
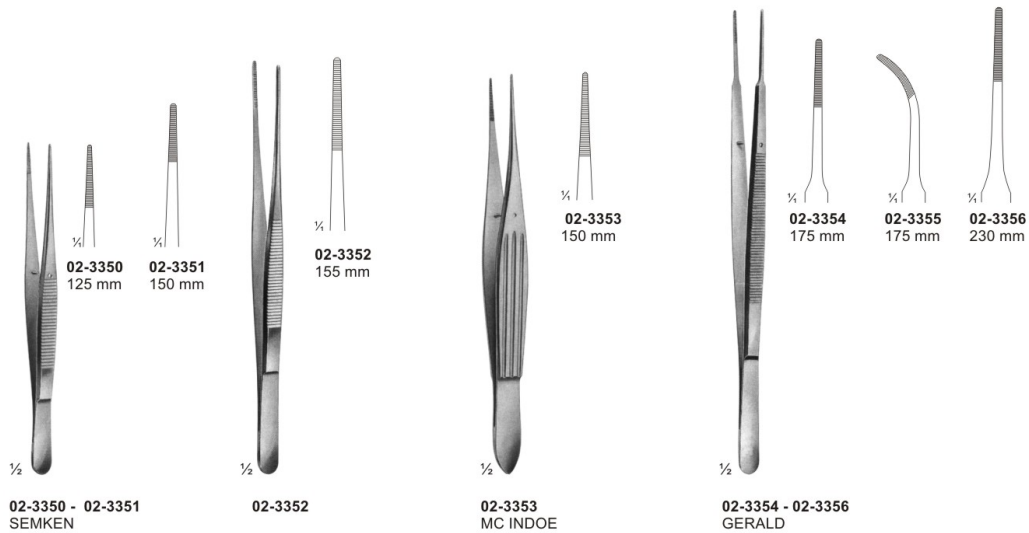

Dissecting Forceps



1/2

02-3366 - 03-3373
STANDARD



1/4

02-3366
115 mm



1/4

02-3367
130 mm



1/4

02-3368
145 mm



1/4

02-3369
160 mm



1/4

02-3370
180 mm



1/4

02-3371
200 mm



1/4

02-3372
250 mm



1/4

02-3373
300 mm



1/2

02-3374 - 02-3378
MEDIUM



1/4

02-3374
115 mm



1/4

02-3375
130 mm



1/4

02-3376
145 mm



1/4

02-3377
160 mm



1/4

02-3378
305 mm



1/2

02-3379 - 02-3380
MEDIUM



1/4

02-3379
130 mm



1/4

02-3380
145 mm

Dissecting Forceps

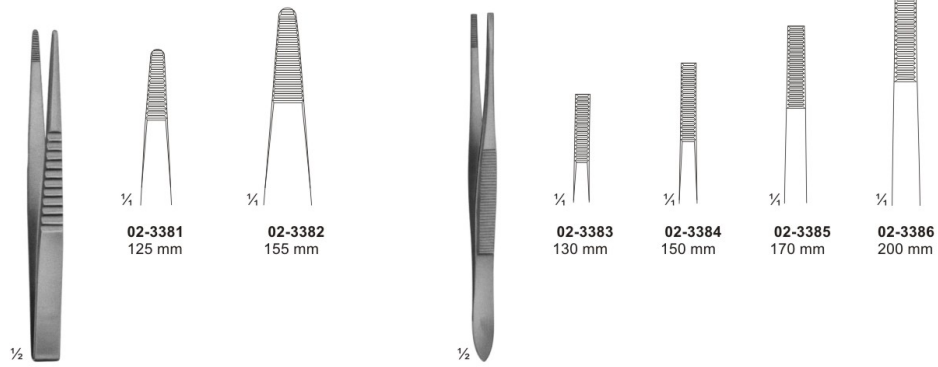

02-3381 - 02-3382

02-3383 - 02-3386
Swedish pattern



02-3387
OCHSNER
Ligature forceps
145mm

02-3388
FRICKE
Artery forceps
130mm

03-3389
BONNEY
175mm

Ultra-Light Forceps ATRAUMATA

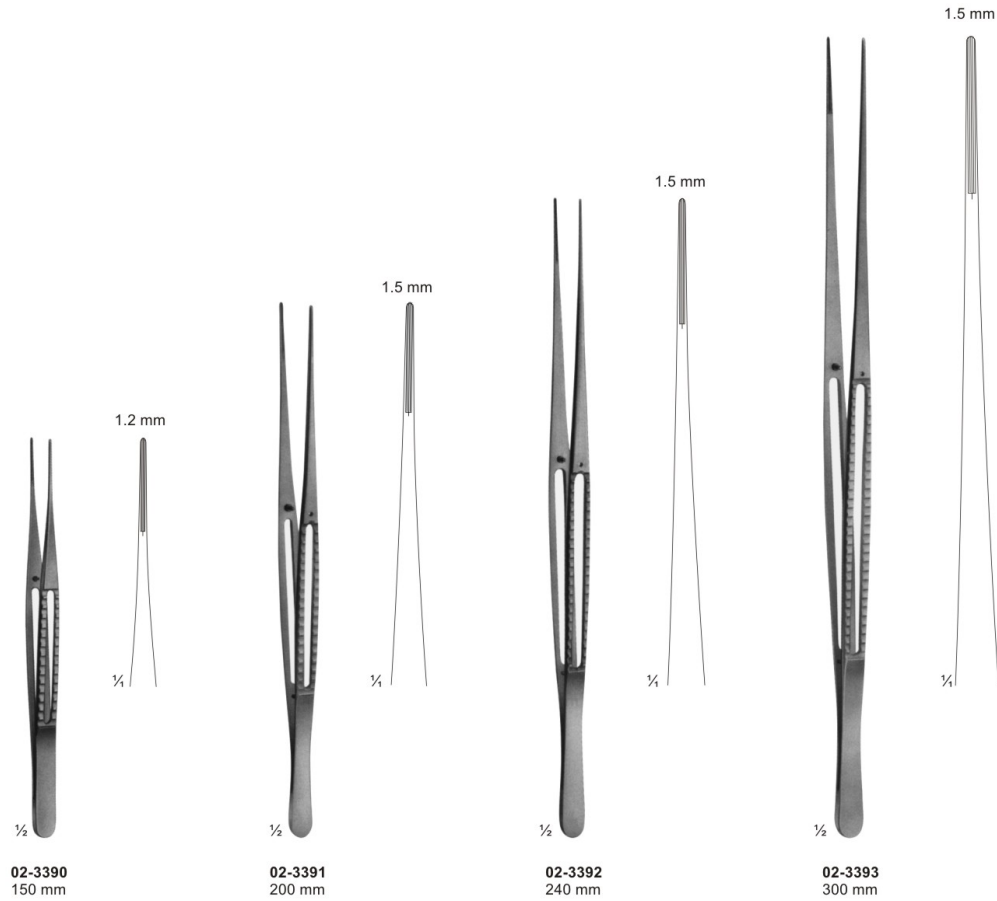

Forceps ATRAUMATA

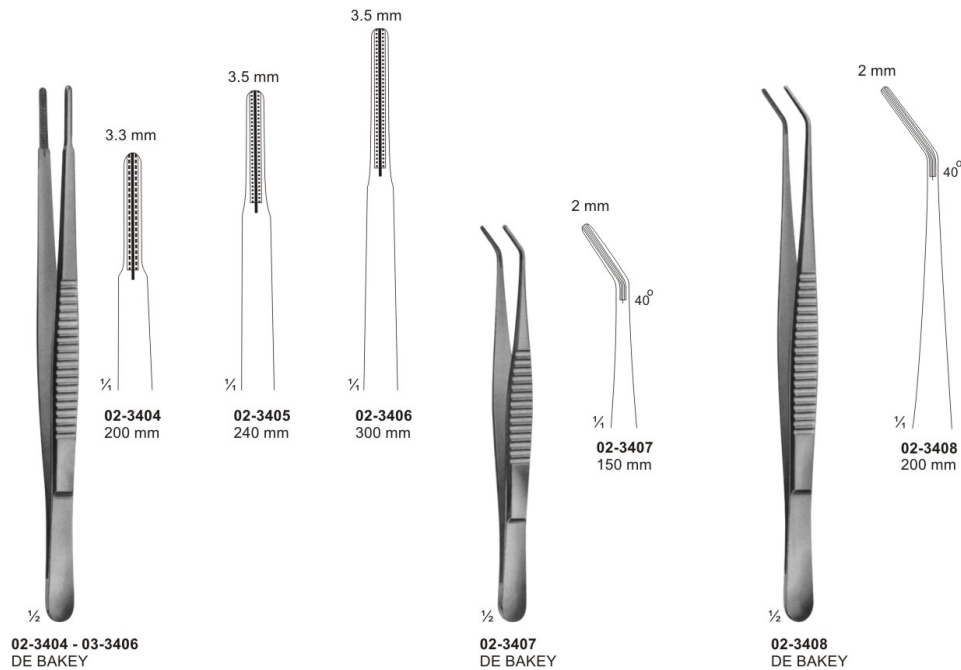
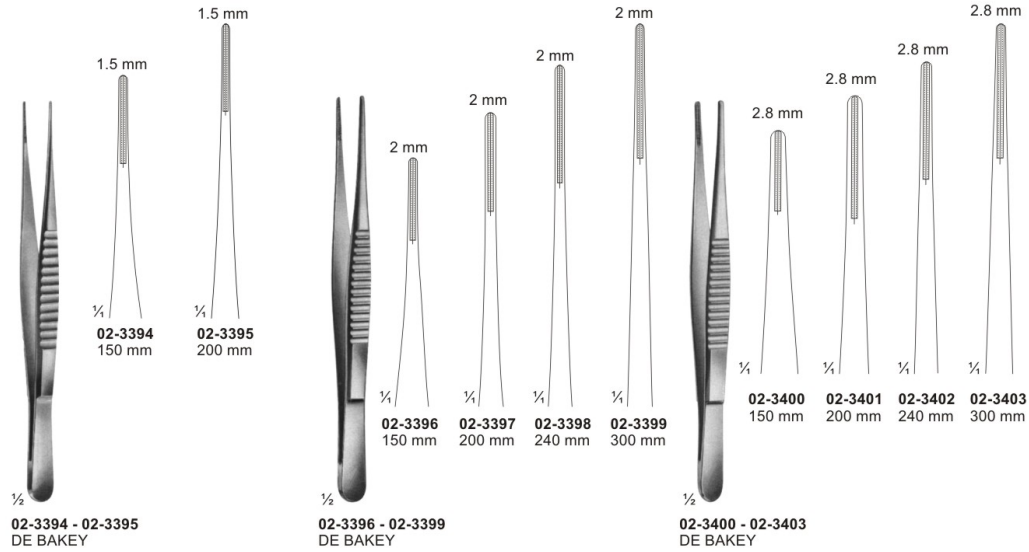

Forceps, Bayonet - Shaped, Angular

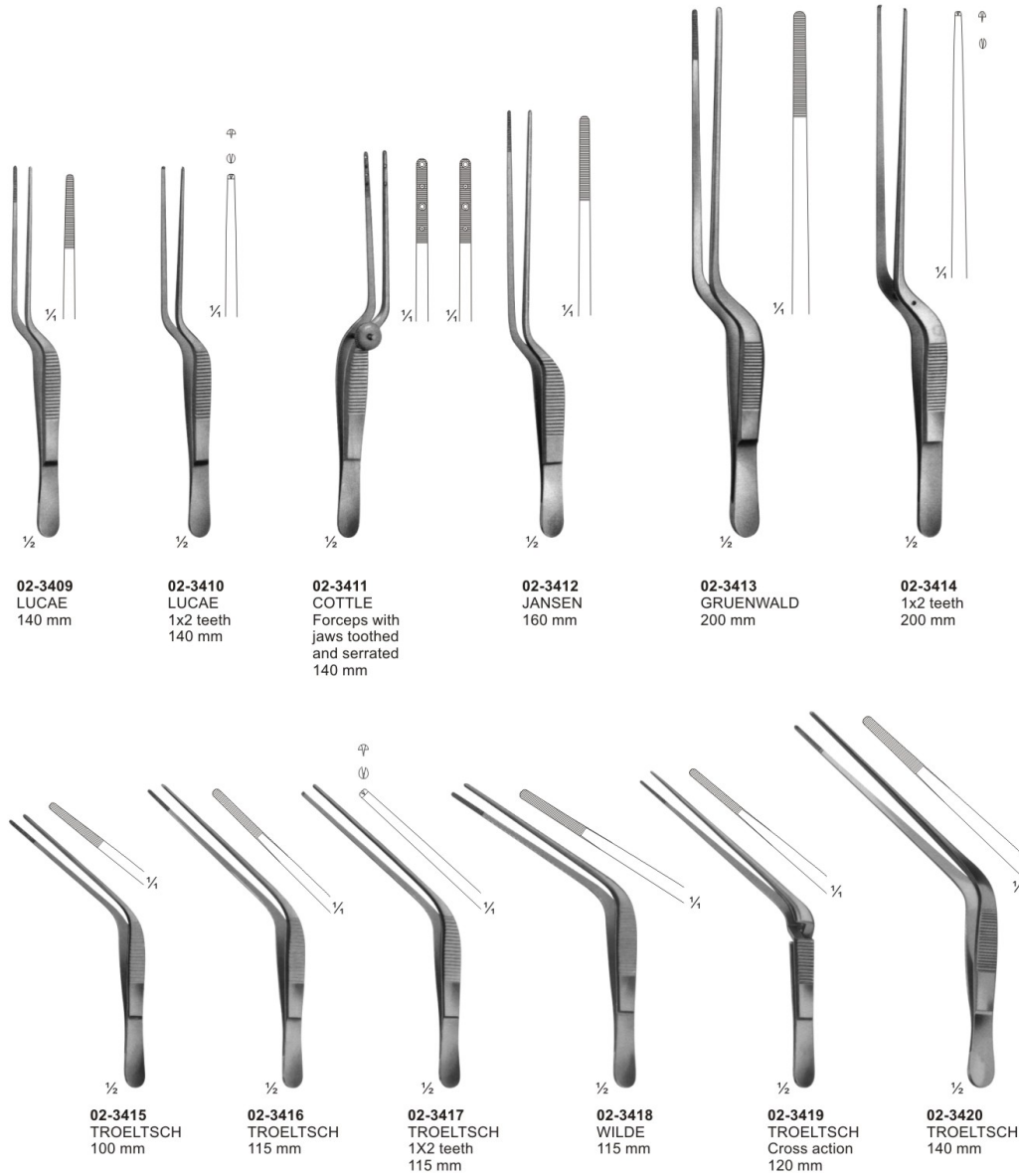

02-3409
LUCAE
140 mm

02-3410
LUCAE
1x2 teeth
140 mm

02-3411
COTTLE
Forceps with
jaws toothed
and serrated
140 mm

02-3412
JANSEN
160 mm

02-3413
GRUENWALD
200 mm

02-3414
1x2 teeth
200 mm

02-3415
TROELTSCH
100 mm

02-3416
TROELTSCH
115 mm

02-3417
TROELTSCH
1X2 teeth
115 mm

02-3418
WILDE
115 mm

02-3419
TROELTSCH
Cross action
120 mm

02-3420
TROELTSCH
140 mm

Delicate Tissue Forceps

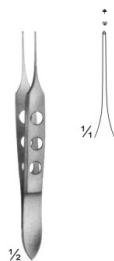

02-3421
BISHOP-HARMON
85 mm

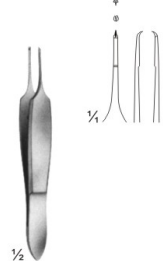

02-3422
ST.MARTIN
80 mm

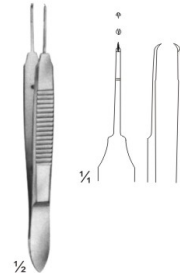

02-3423
CASTROVIEJO
teeth 0.9 mm
100 mm

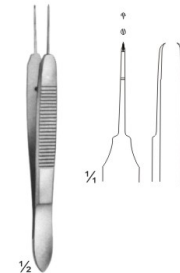

02-3424
CASTROVIEJO
teeth 0.5 mm
100 mm

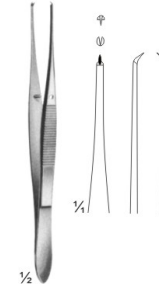

02-3425
ELSCHING
110 mm

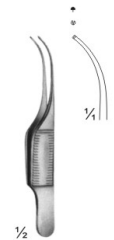

02-3426
GILL
75 mm

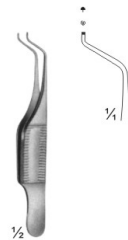

02-3427
GILL - HESS
75 mm

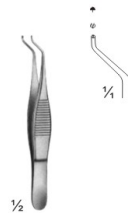

02-3428
HESS
70 mm

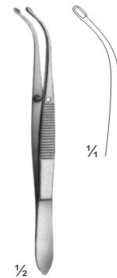

02-3429
ARRUGA
100 mm

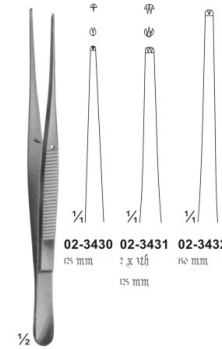

02-3430 02-3431 02-3432
SEMKEN
125 mm 125 mm 150 mm

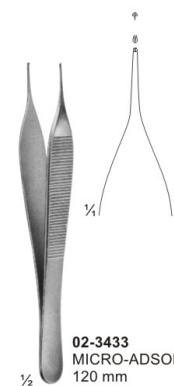

02-3433
MICRO-ADSON
120 mm

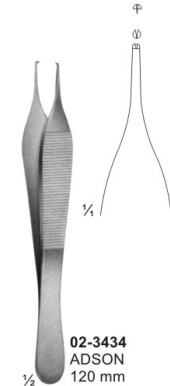

02-3434
ADSON
120 mm

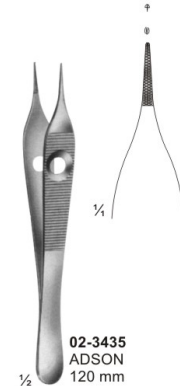

02-3435
ADSON
120 mm

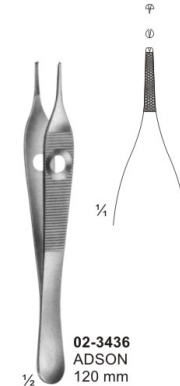

02-3436
ADSON
120 mm

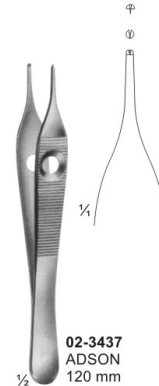

02-3437
ADSON
120 mm

Tissue Forceps

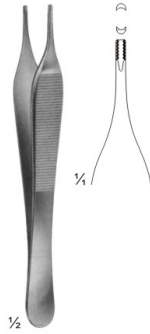

02-3438
ADSON - BROWN
Non-traumatic
120 mm

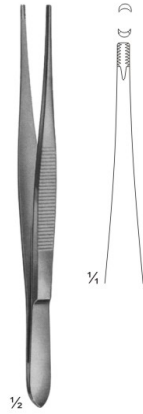

02-3439
BROWN
150 mm



02-3440
GRAEFE
110 mm

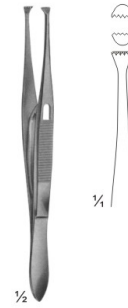

02-3441
GRAEFE
With Catch
110 mm

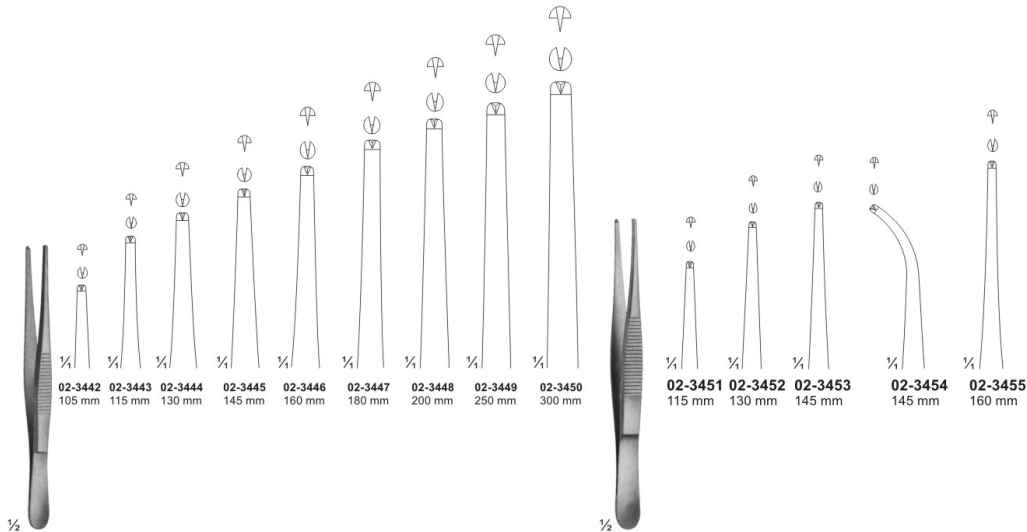

02-3442 - 02-3450
STANDARD

02-3451 - 02-3455
Medium

Tissue Forceps

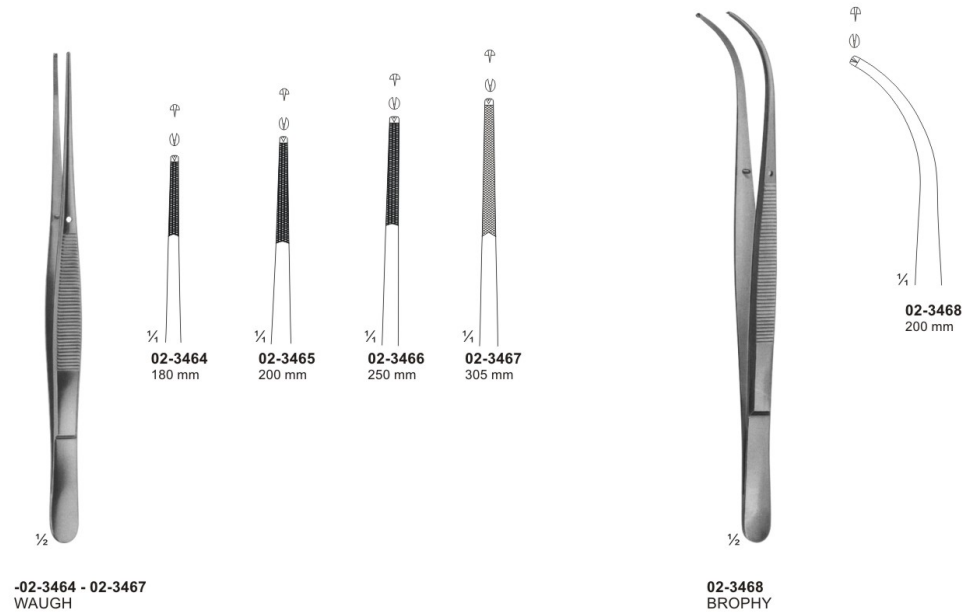
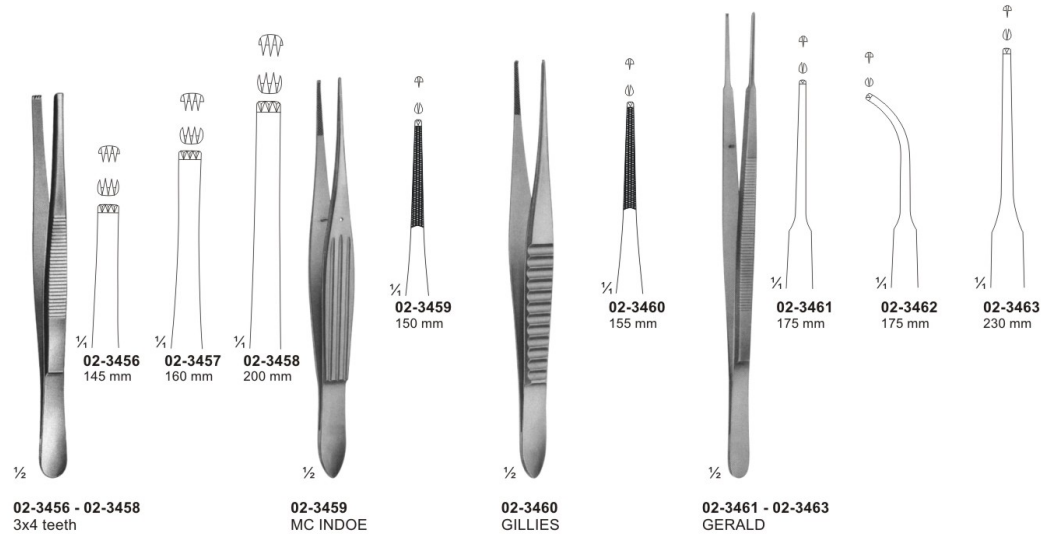

**Tissue Forceps, Lung Dissecting Forceps,
Intestinal Forceps**



Splinter and Cilia Forceps

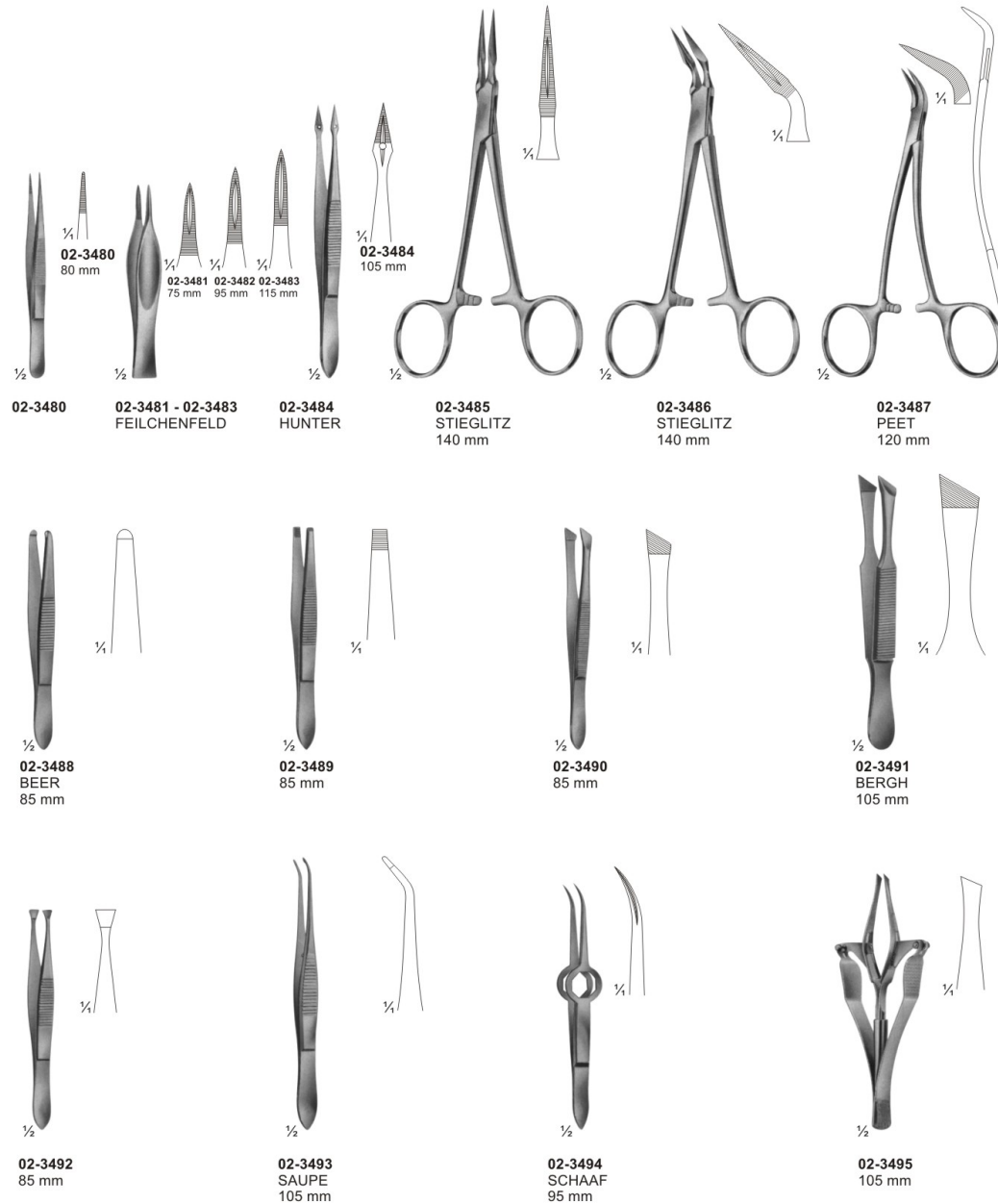

Sponge and Dressing Forceps

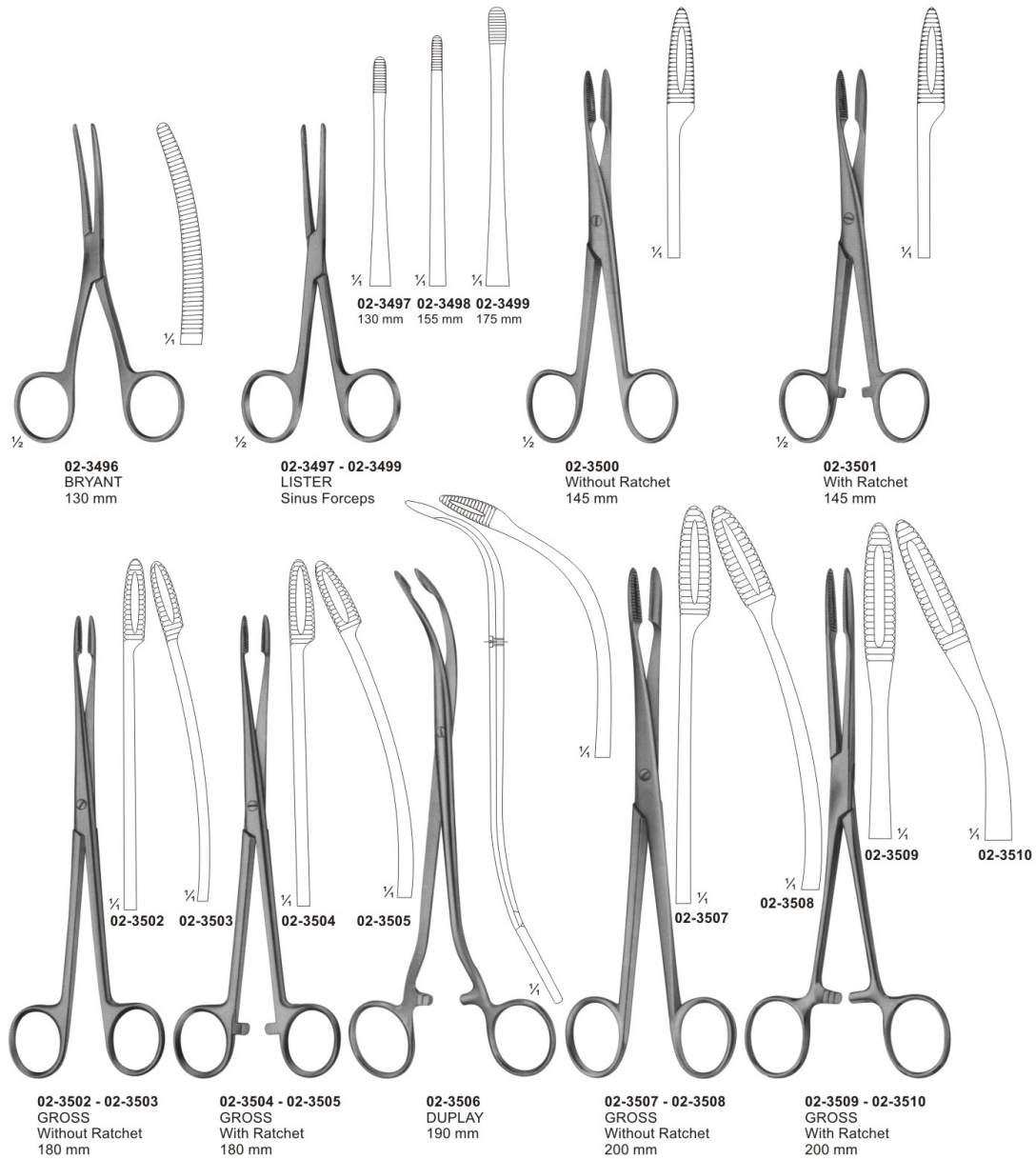

Sponge and Dressing Forceps

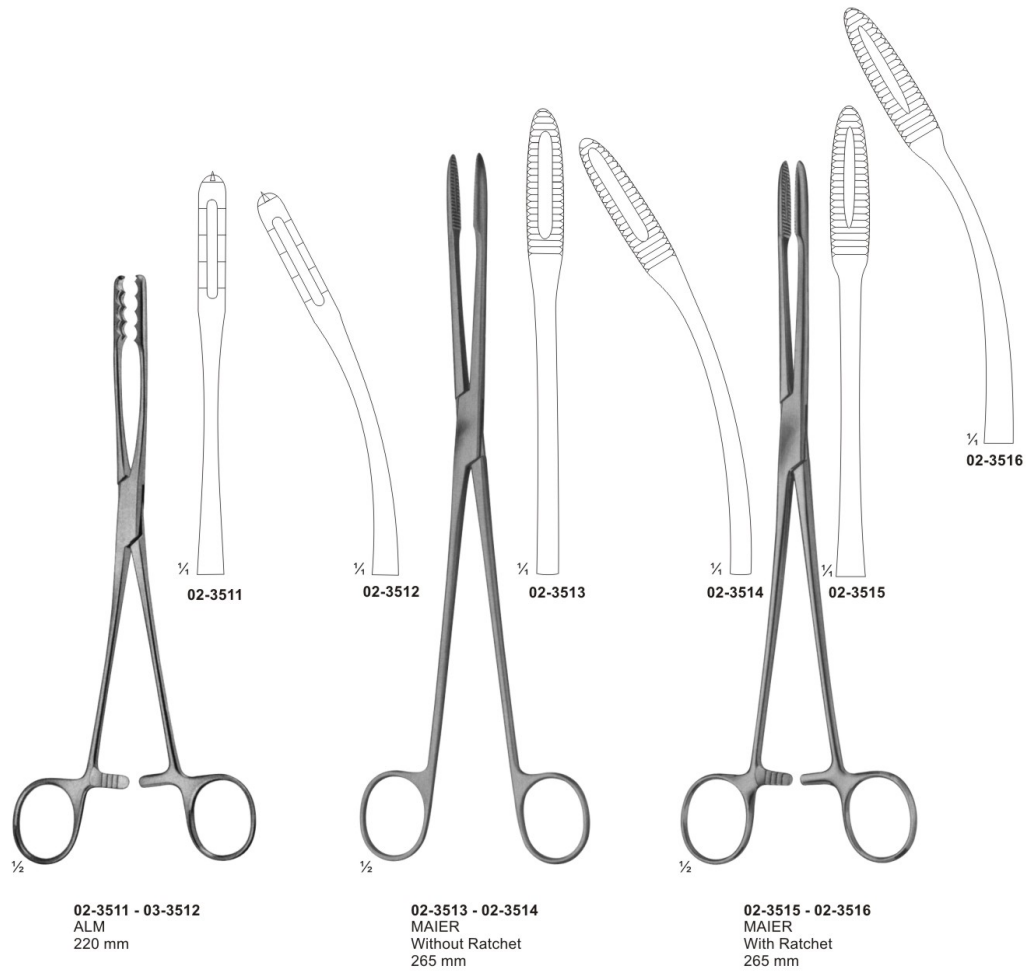

Sponge and Dressing Forceps

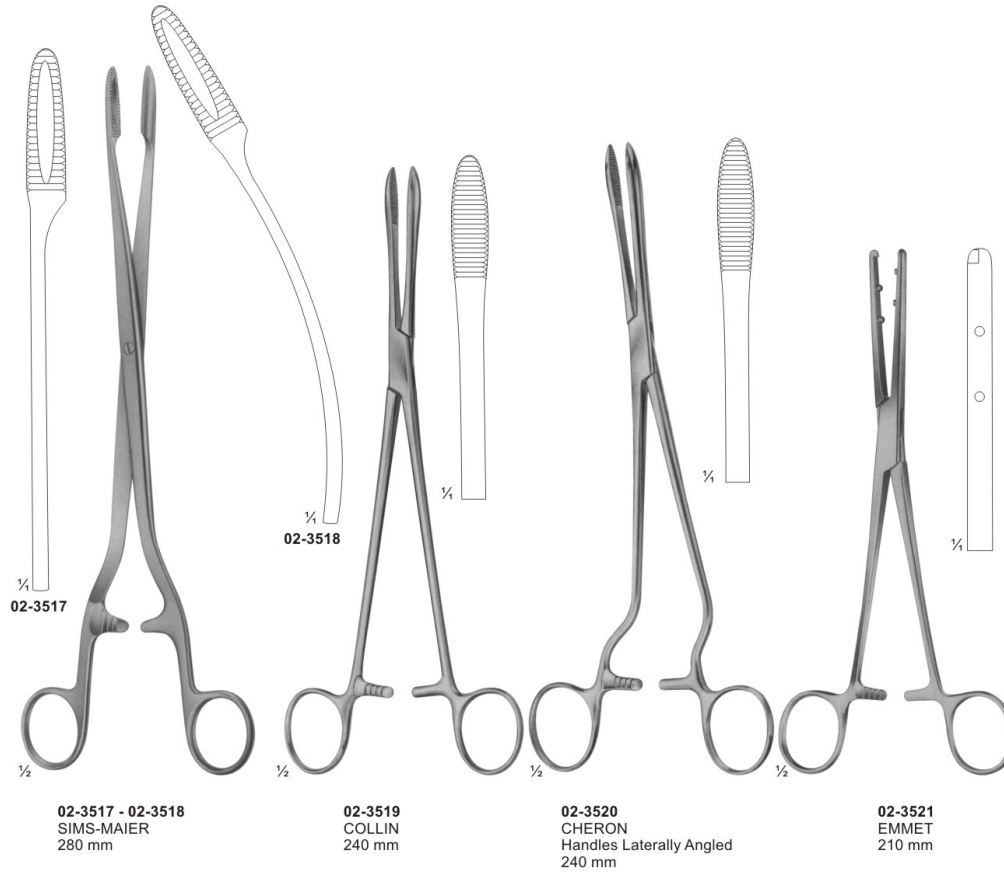

**Dressing, Sponge Holding, Organ and Tissue
Grasping Forceps and Haemostatic Forceps**

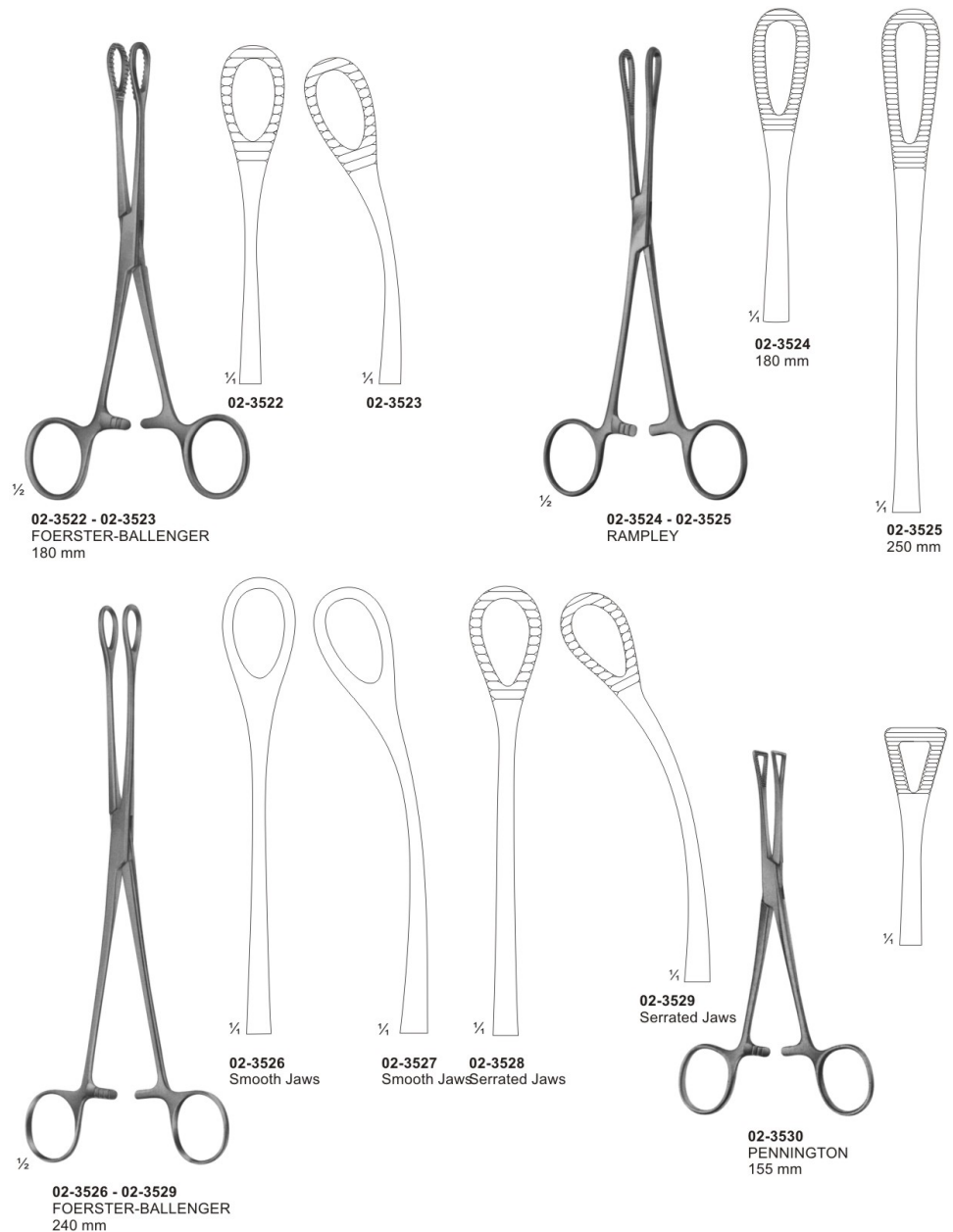

Tendon Seizing Forceps

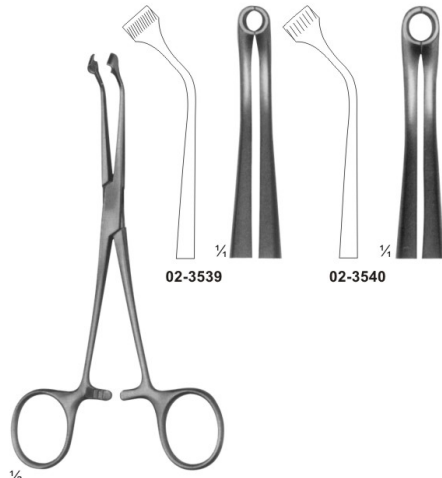

02-3539

02-3540

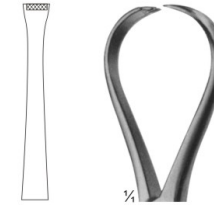

02-3541

1/2

02-3539 - 02-3540
HERZ
155 mm

1/2

02-3541
JACKSON
4 x 5 teeth
150 mm

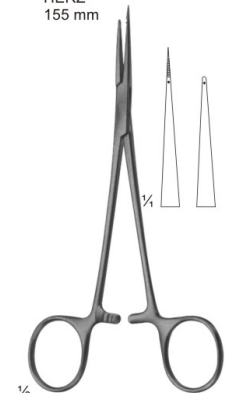

1/2
02-3542
Tendon interlacing
forceps
150 mm

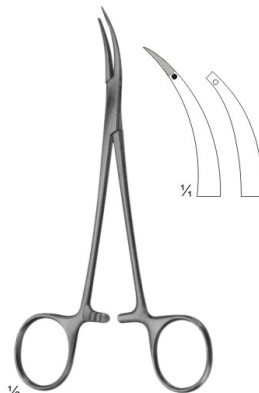

1/2
02-3543
Tendon interlacing
forceps
150 mm



1/2
02-3544
Tendon seizing
forceps
120 mm

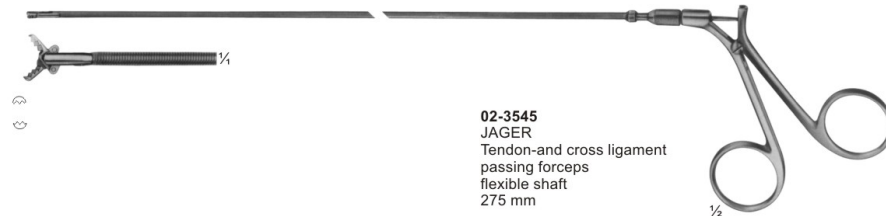

1/2
02-3545
JAGER
Tendon and cross ligament
passing forceps
flexible shaft
275 mm

Artery Traction - and Tissue Grasping Forceps

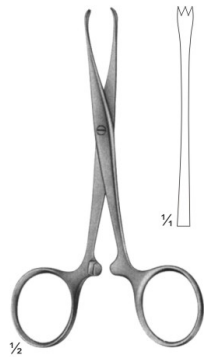

02-3546
CHAPUT
2 x 3 teeth sharp
125 mm

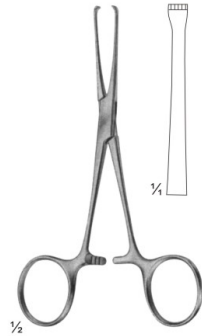

02-3547
BABY-ALLIS
4 x 5 teeth
130 mm

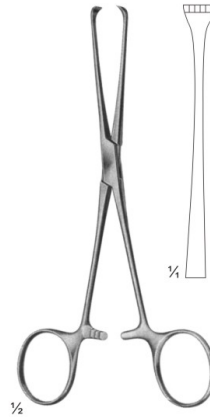

02-3548
BOYS-ALLIS
5 x 6 teeth sharp
155 mm

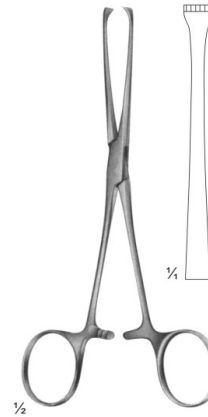

02-3549
ALLIS
5 x 6 teeth blunt
155 mm

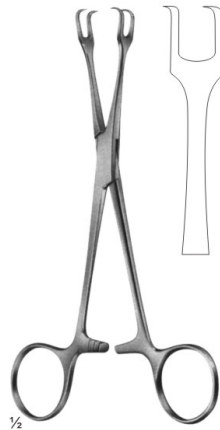

02-3550
LAHEY
155 mm

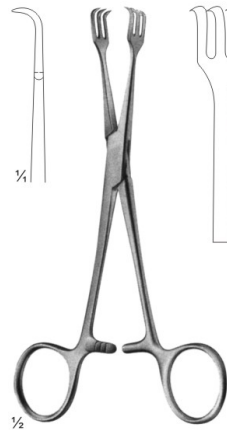

02-3551
LAHEY
155 mm

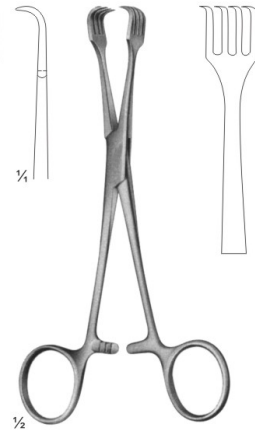

02-3552
BRAUN
155 mm

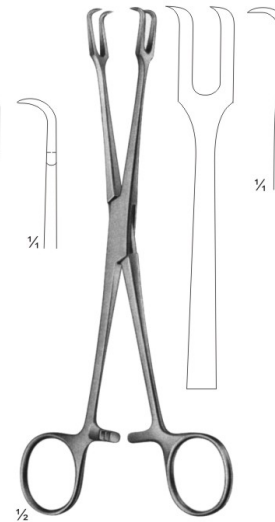

02-3553
MUSEUX
200 mm

Organ - and Tissue Grasping Forceps

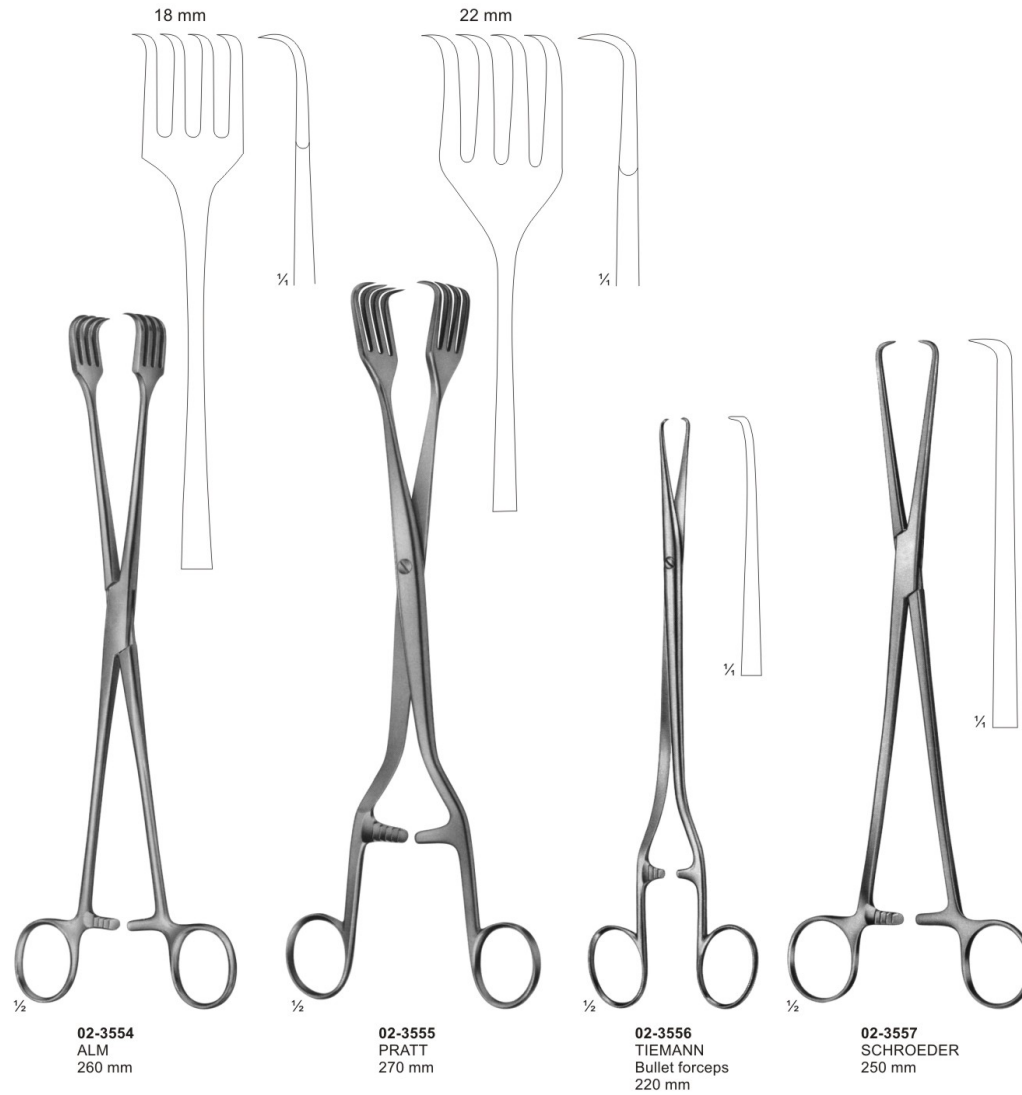

Towel Clamps

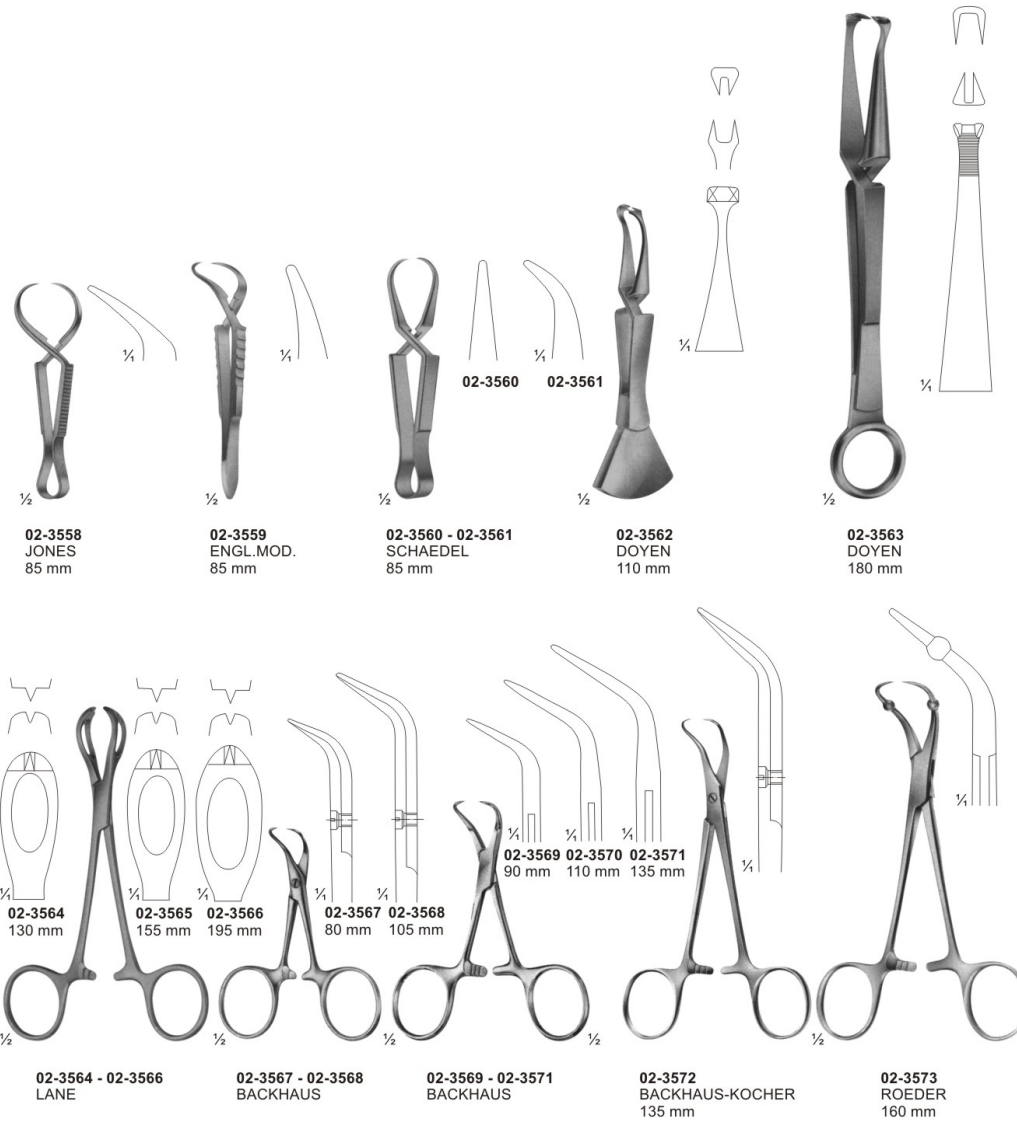

Towel Clamps and Safety Pins.

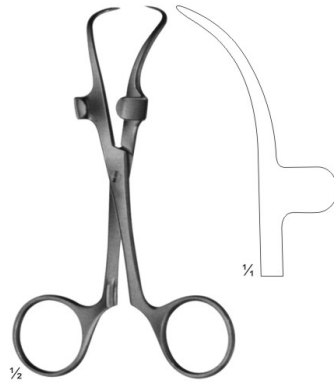

02-3574
ROBIN
with holders for tubing
up to 13 mm
135 mm



02-3575
with clip for tubing
up to 15 mm
110 mm

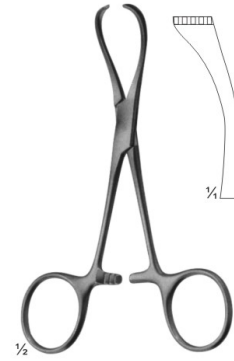

02-3576
LORNA
non perforating
130 mm

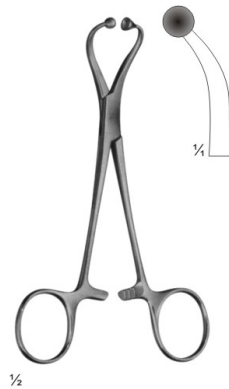

02-3577
for paper cloths
140 mm

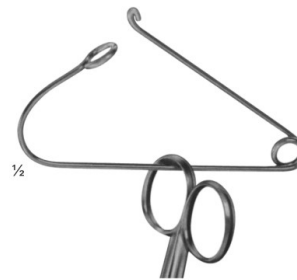

02-3578
BUNT
105 mm



02-3579
MAYO
140 mm

Muller Vessel Clips and Bulldog Clamps

Closing force



02-3580
Straight
50g



02-3581
Curved
80g



02-3582
Curved
50g



02-3583
Curved
80g



02-3584
Curved tips
50g



02-3585
80g



02-3586
Angled
Shaped
50g



02-3587
80g



02-3588
Muller
Knee-bent
50g



02-3589
80g



02-3590
Muller
Ligature Forceps



Jaw, cross
serrated
Jaws profiles
finally cross-
serrated.

Non-traumatic vessel clips, temporary.



02-3591
38 mm
48 mm



02-3592
38 mm
48 mm



02-3593
58 mm



02-3594
58 mm



02-3595 - 02-3601

- 02-3595 38 mm
- 02-3596 48 mm
- 02-3597 56 mm
- 02-3598 63 mm
- 02-3599 70 mm
- 02-3600 80 mm
- 02-3601 91 mm



02-3602
DE BAKEY-
HESS
Length of
Jaws 20 mm

Bulldog Clamps

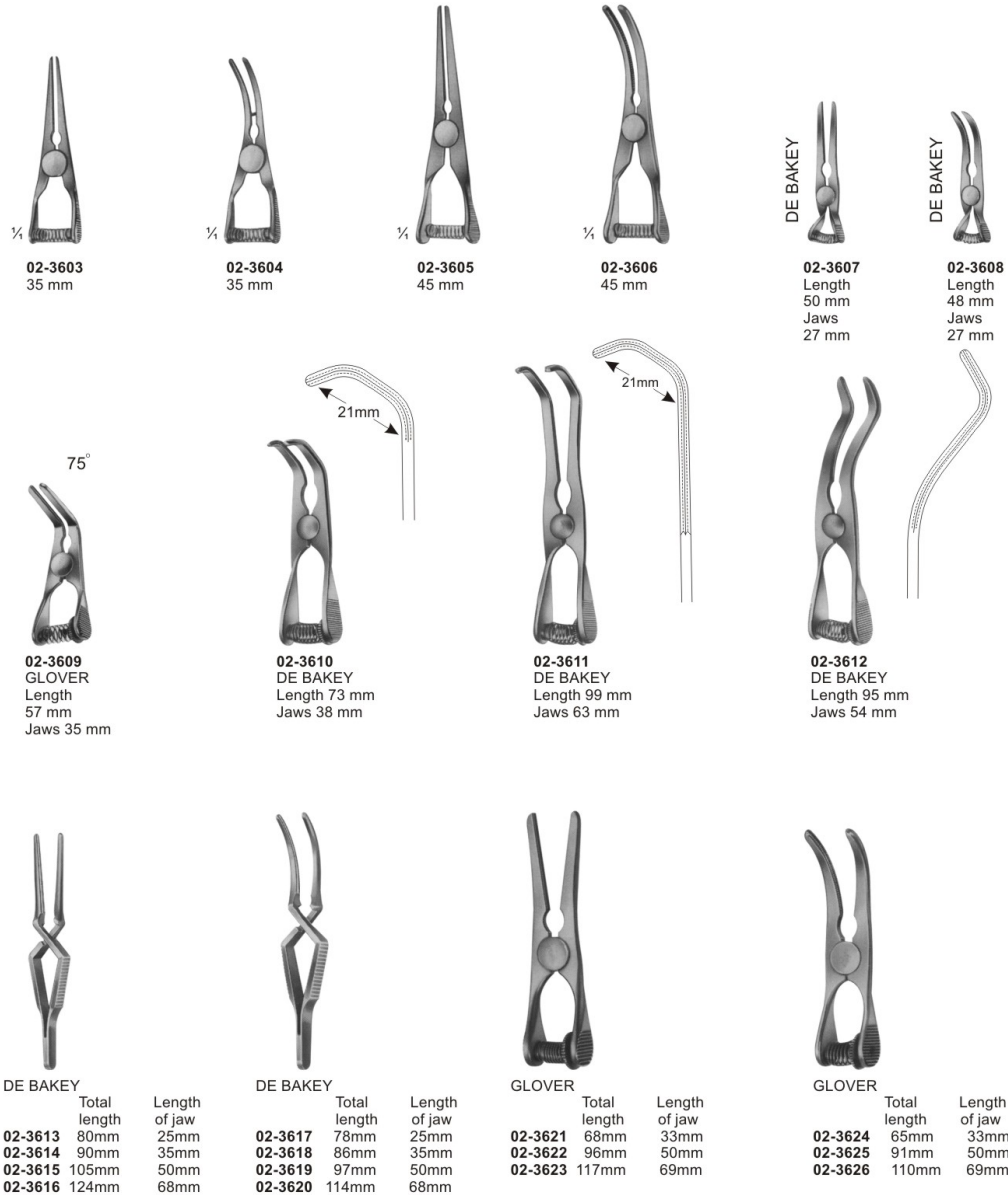

Delicate Haemostatic Forceps



02-3627
CARREL
85 mm



02-3628 - 02-3631
BABY-MOSQUITO
(HARTMANN)
100 mm



02-3632 - 02-3635
MICRO-HALSTED
125 mm



02-3636 - 02-3639
HALSTED-MOSQUITO
125 mm

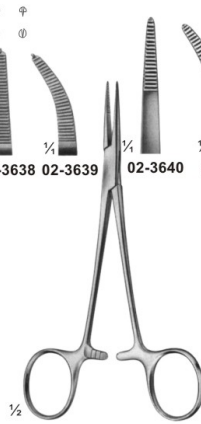

02-3640 - 02-3641
PROVIDENCE-HOSPITAL
140 mm

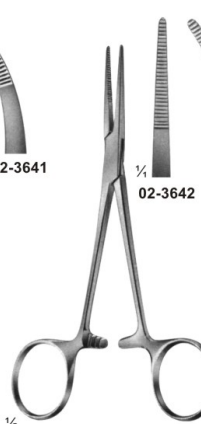

02-3642 - 02-3643
KELLY
140 mm

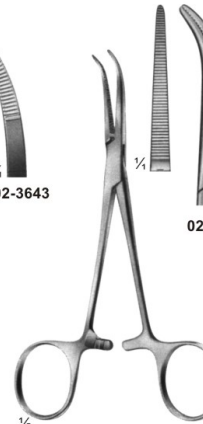

02-3644 - 02-3645
DANDY
Curved sideways
140 mm

Delicate Haemostatic Forceps

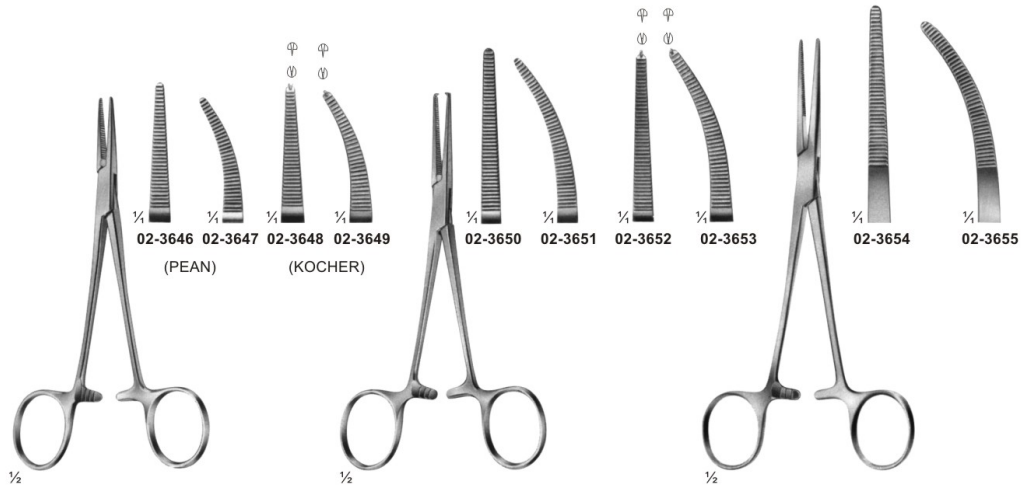

02-3646 - 02-3649
BABY-CRILE
140 mm

02-3650 - 02-3653
CRILE
140 mm

02-3654 - 02-3655
RANKIN
160 mm

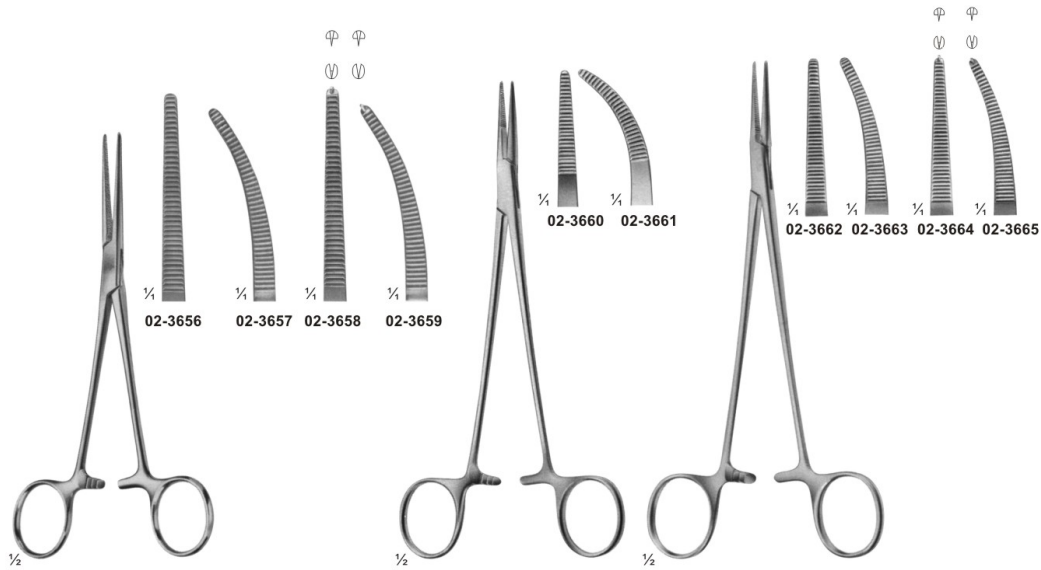

02-3656 - 02-3659
CRILE
160 mm

02-3660 - 02-3661
ADSON
185 mm

02-3662 - 02-3665
HALSTED
185 mm

Delicate Haemostatic Forceps

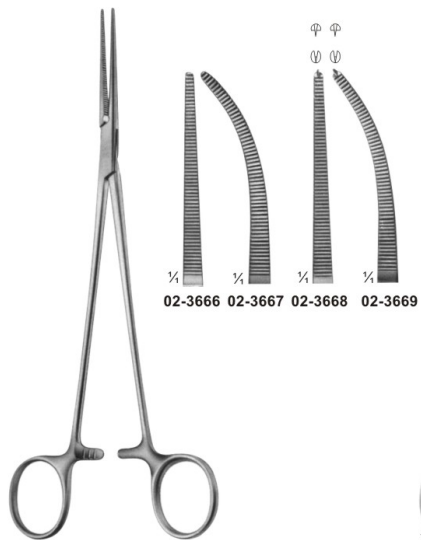

02-3666 - 02-3669
HALSTED-MOSQUITO
200 mm

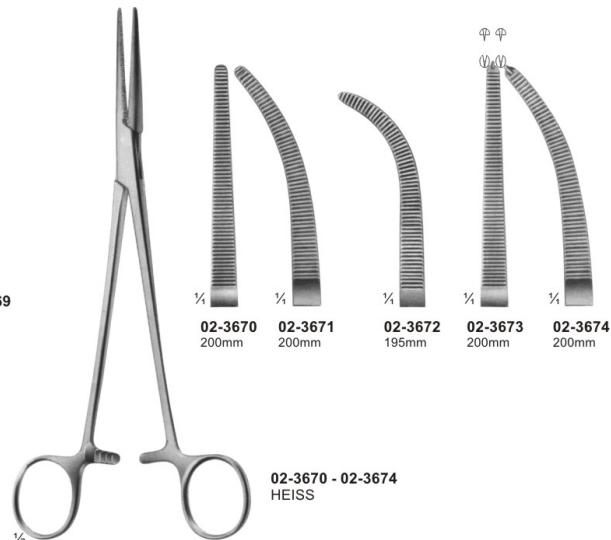

02-3670 - 02-3674
HEISS



02-3675 - 02-3676
HALSTED
215 mm

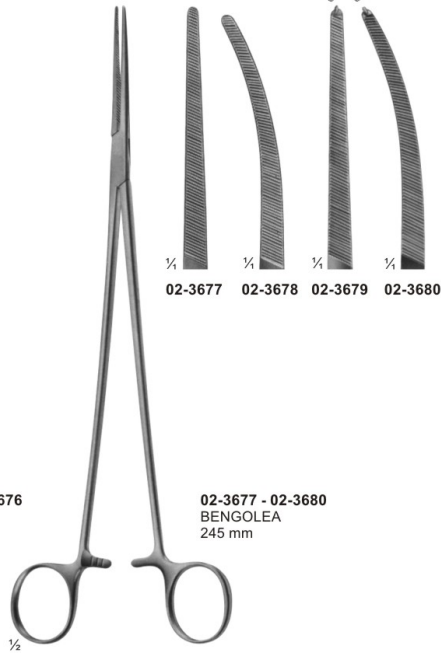

02-3677 - 02-3680
BENGOLEA
245 mm



02-3681
CRAFOORD
245 mm

Haemostatic Forceps

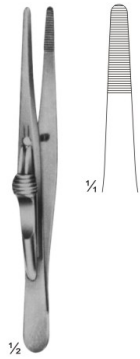

02-3682
FRICKE
Artery forceps
130 mm

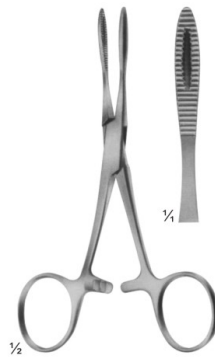

02-3683
KRONLEIN
130 mm

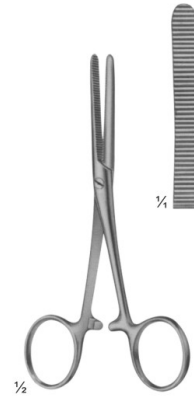

02-3684
PEAN
125 mm



02-3685
125 mm



02-3686
140 mm

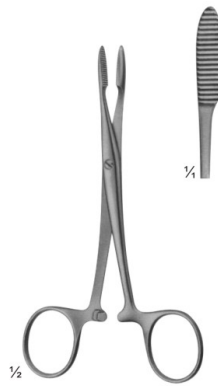

02-3687
PEAN
125mm

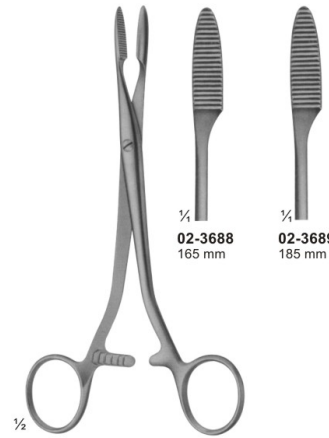

02-3688
165 mm



02-3689
185 mm

02-3685 - 02-3686
PEAN

02-3688 - 02-3689
PEAN

Haemostatic Forceps

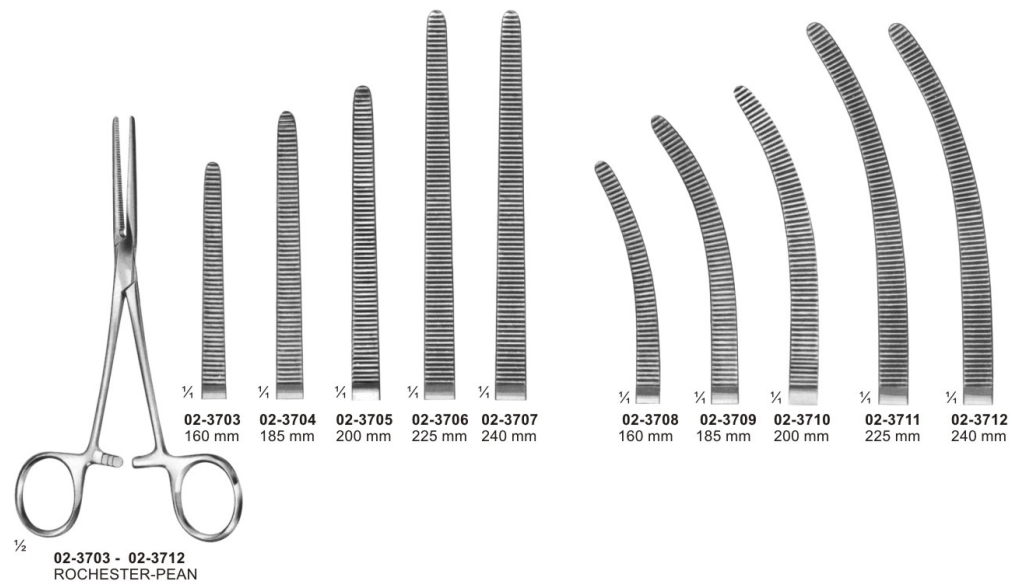
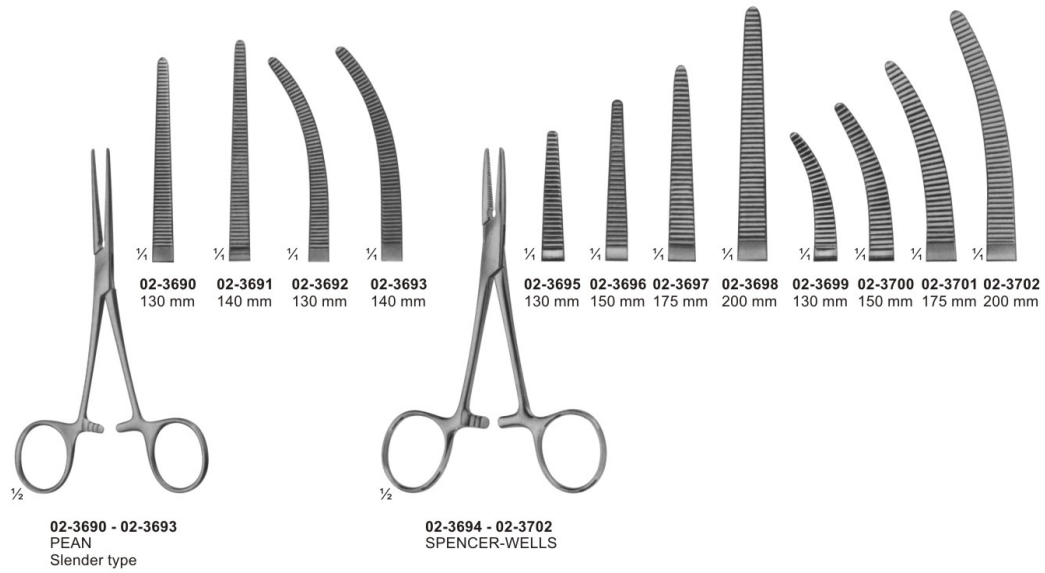

Haemostatic Forceps

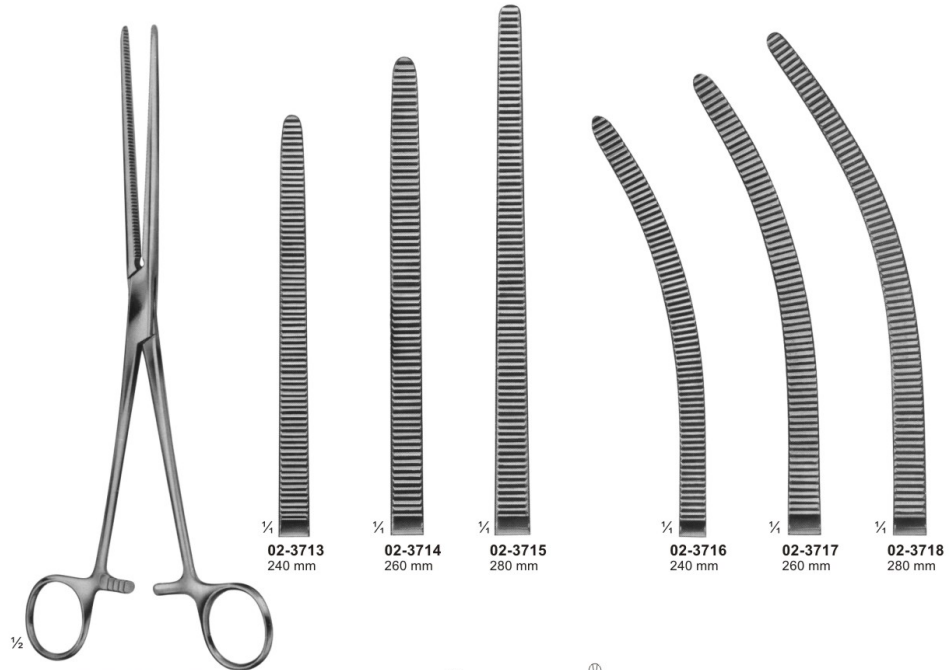

02-3713 - 02-3718
PEAN

02-3713 240 mm
02-3714 260 mm
02-3715 280 mm
02-3716 240 mm
02-3717 260 mm
02-3718 280 mm

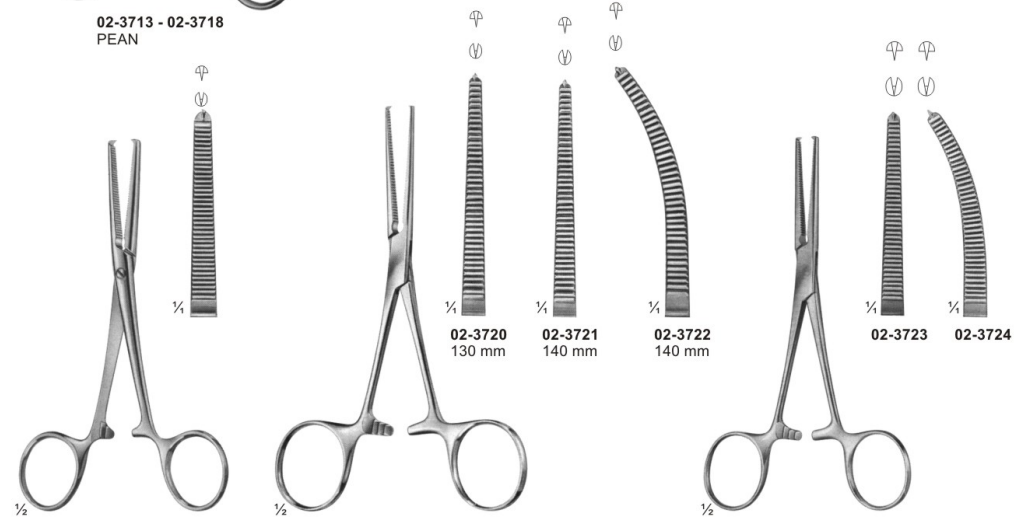

02-3719
KOCHER
Strong Pattern
145 mm

02-3720 - 02-3722
KOCHER

02-3723 - 02-3724
ROCHESTER-OCHSNER
140 mm

Haemostatic Forceps

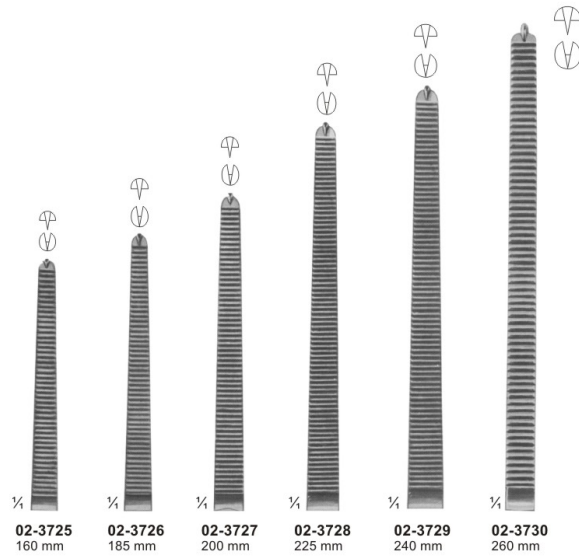

02-3725 - 02-3736
KOCHER-OCHSNER

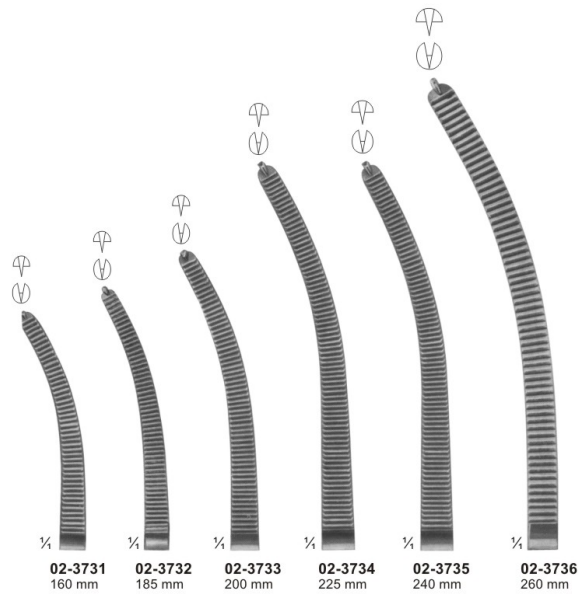

**Haemostatic Forceps, Special Pattern,
Tonsil Forceps**

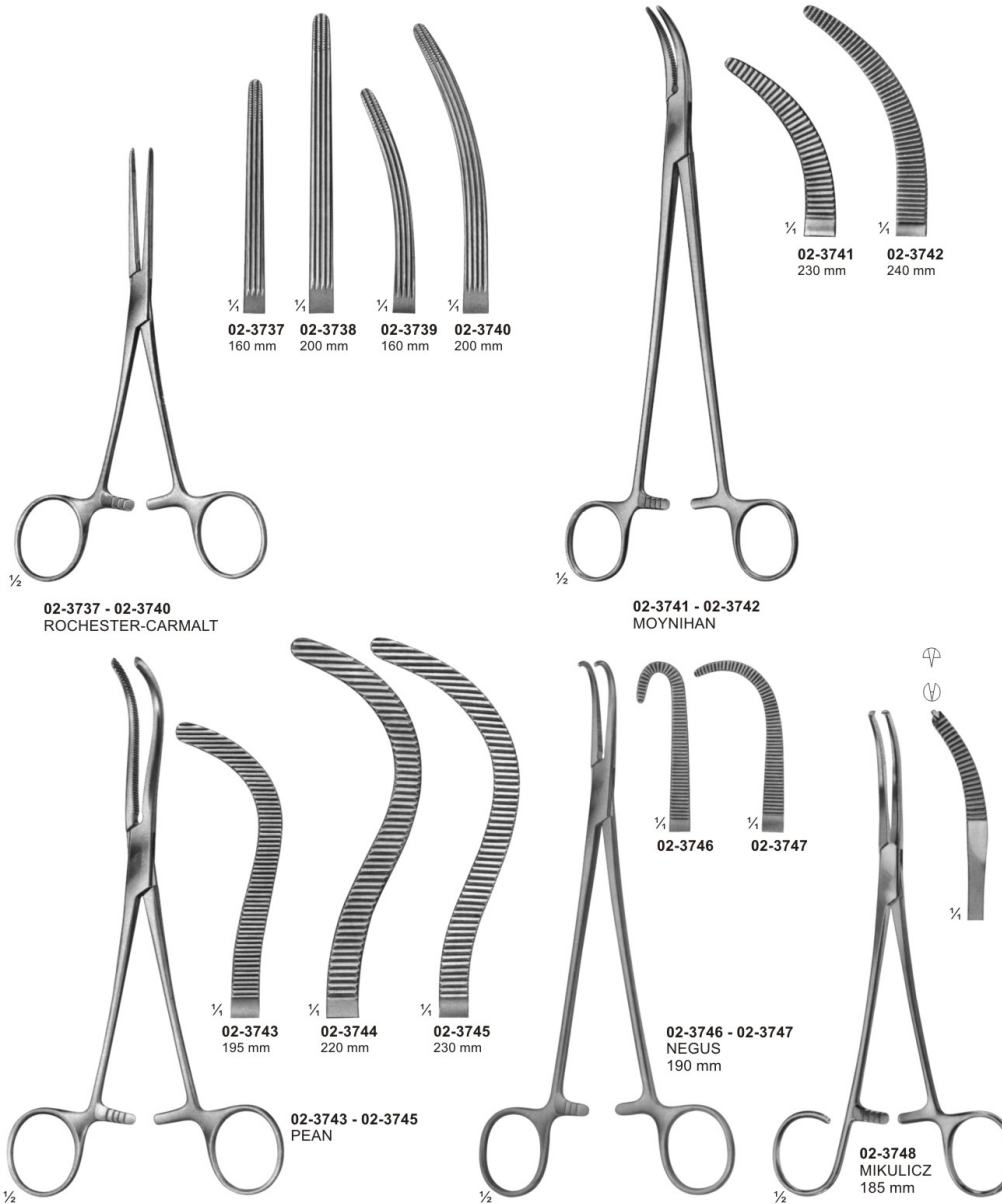

Dissecting- and Ligature Forceps

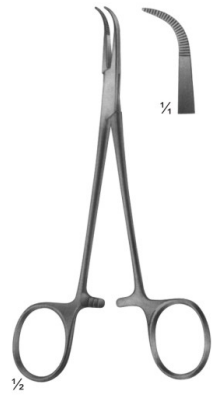

02-3749
MICRO-ADSON
140 mm



02-3750
BABY-OVERHOLT
135 mm

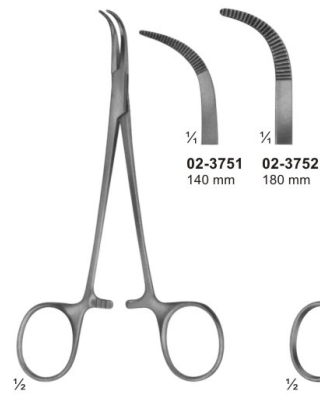

02-3751 - 02-3752
BABY-MIXTER

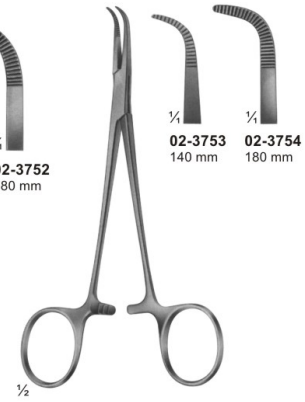

02-3753 - 02-3754
BABY-ADSON

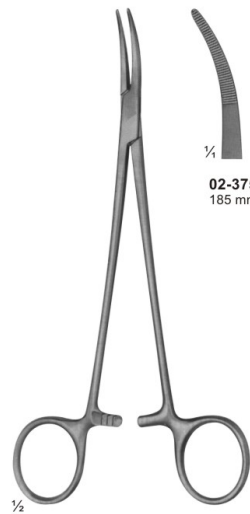

02-3755
NISSEN



02-3755
185 mm



02-3756 - 02-3757
YASARGIL
195 mm



02-3756



02-3757



02-3758
OVERHOLT-MIXTER



02-3758
205 mm

Dissecting- and Ligature Forceps

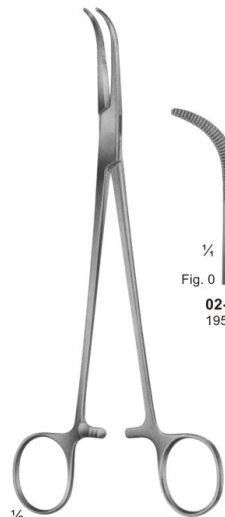

1/2

02-3759 - 02-3770
OVERHOLT-GEISSENDOERFER

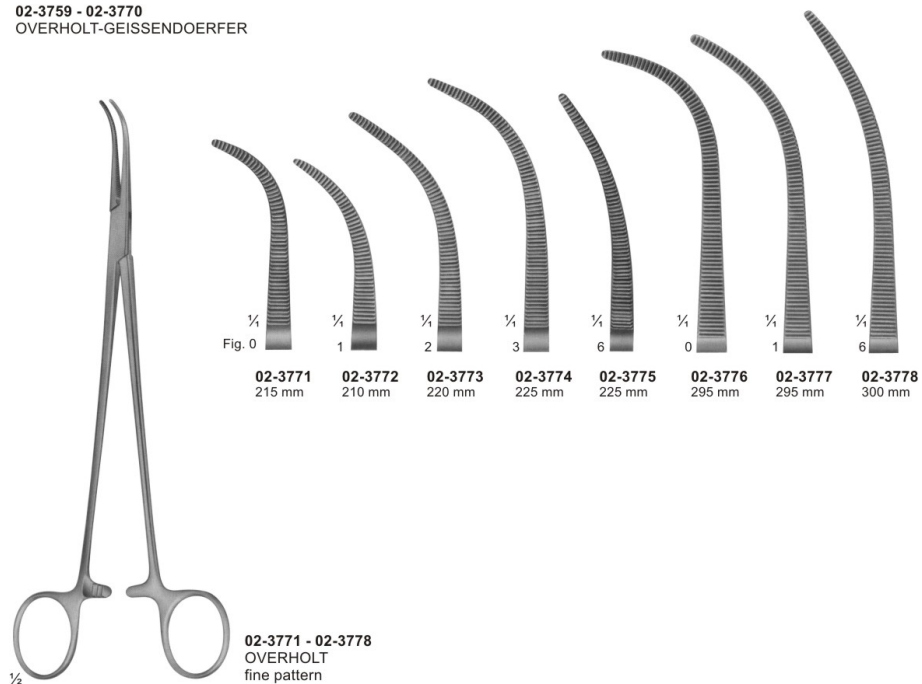
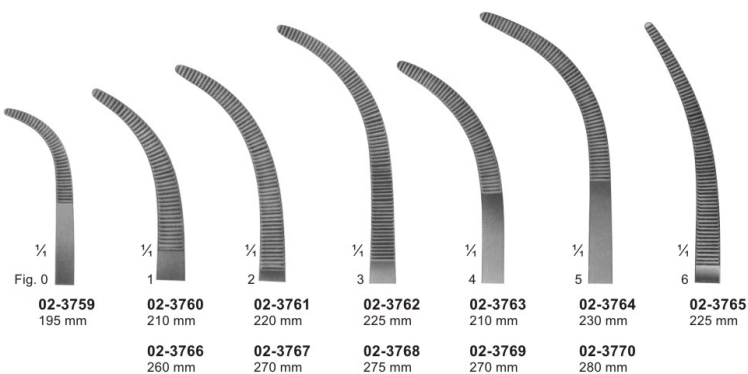

1/2

02-3771 - 02-3778
OVERHOLT
fine pattern

Dissecting- and Ligature Forceps

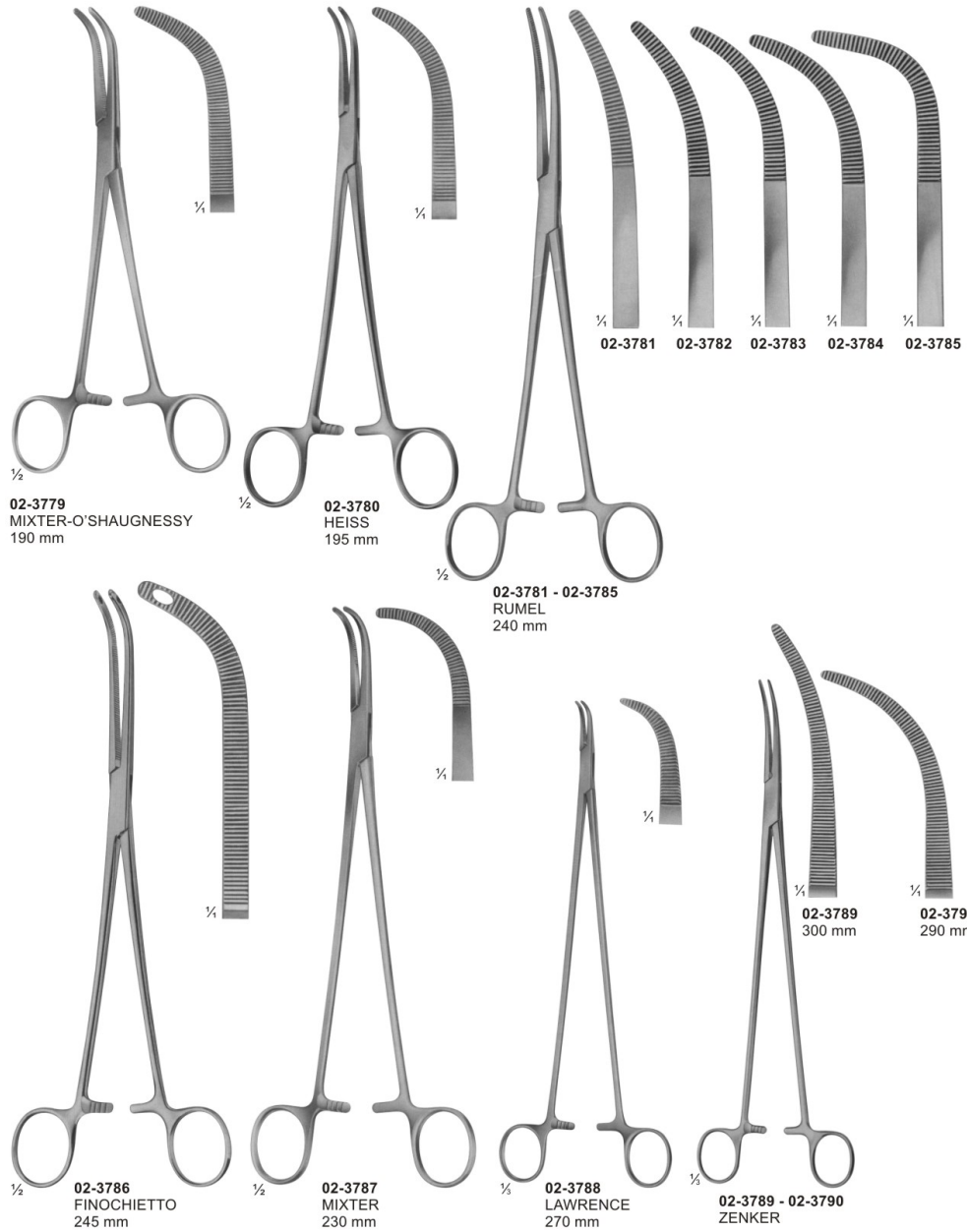

Dissecting- and Ligature Forceps

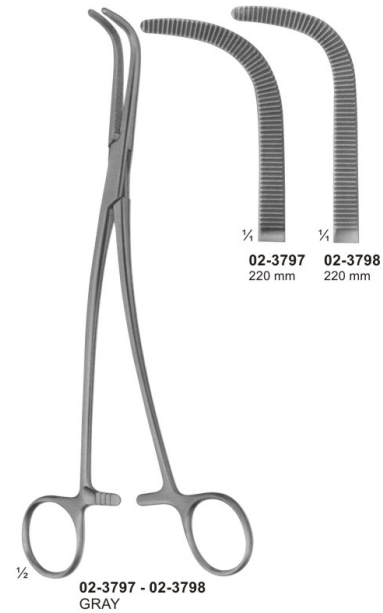
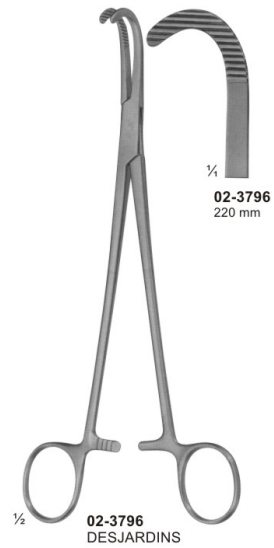

Peritoneum Forceps

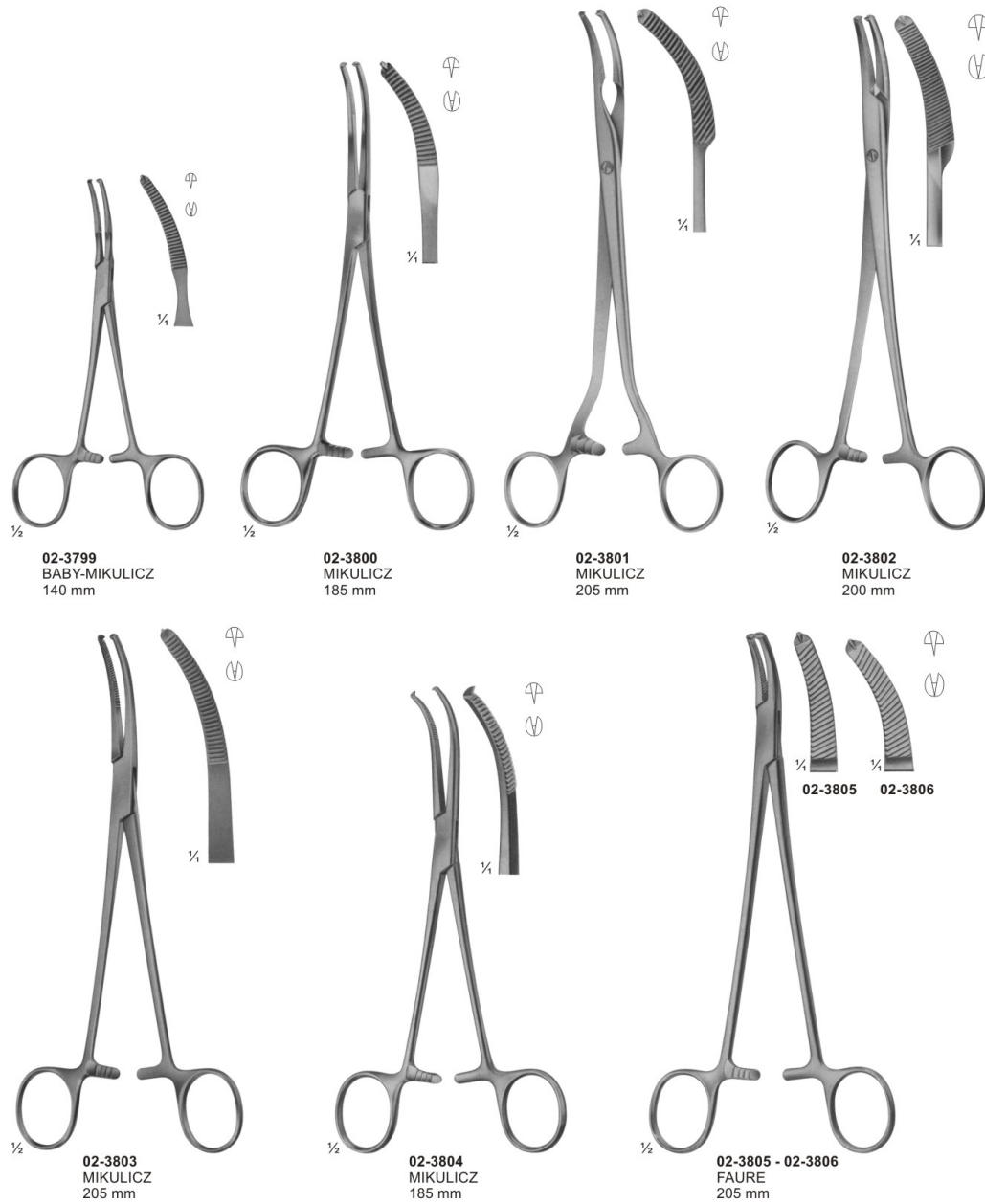

02-3799
BABY-MIKULICZ
140 mm

02-3800
MIKULICZ
185 mm

02-3801
MIKULICZ
205 mm

02-3802
MIKULICZ
200 mm

02-3803
MIKULICZ
205 mm

02-3804
MIKULICZ
185 mm

02-3805 - 02-3806
FAURE
205 mm

Hysterectomy and Haemostatic Forceps



02-3807
210 mm

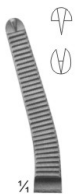

02-3808
205 mm

02-3807 - 02-3808
PHANEUF



02-3809
205 mm



02-3810
245 mm

02-3809 - 02-3810
HEANEY modif.

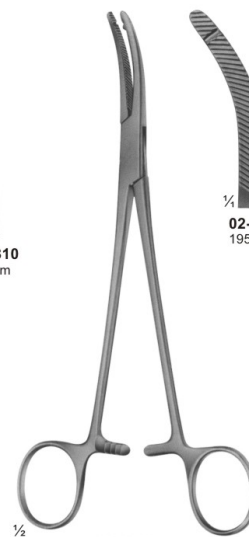

02-3811
195 mm

02-3811
HEANEY

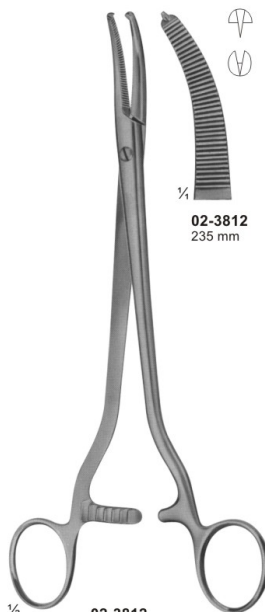

02-3812
235 mm

02-3812
WERTHEIM

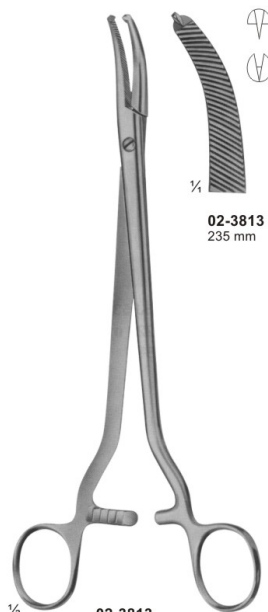

02-3813
235 mm

02-3813
WERTHEIM



02-3814
245 mm

02-3814
WERTHEIM

Atraumata Hysterectomy Forceps and Vaginal Clamps ATRAUMATA



½ 02-3815 - 02-3818
HEANEY



¼ 02-3815
225 mm



¼ 02-3816
220 mm



¼ 02-3817
215 mm



¼ 02-3818
205 mm



½ 02-3819 - 02-3822
WERTHEIM
Parametrium clamps



¼ 02-3819
250 mm



¼ 02-3820
245 mm



¼ 02-3821
240 mm

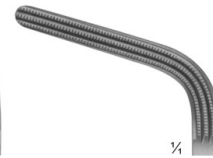

¼ 02-3822
220 mm

**Hysterectomy Forceps and Vaginal Clamps
and Compression Forceps ATRAUMATA**

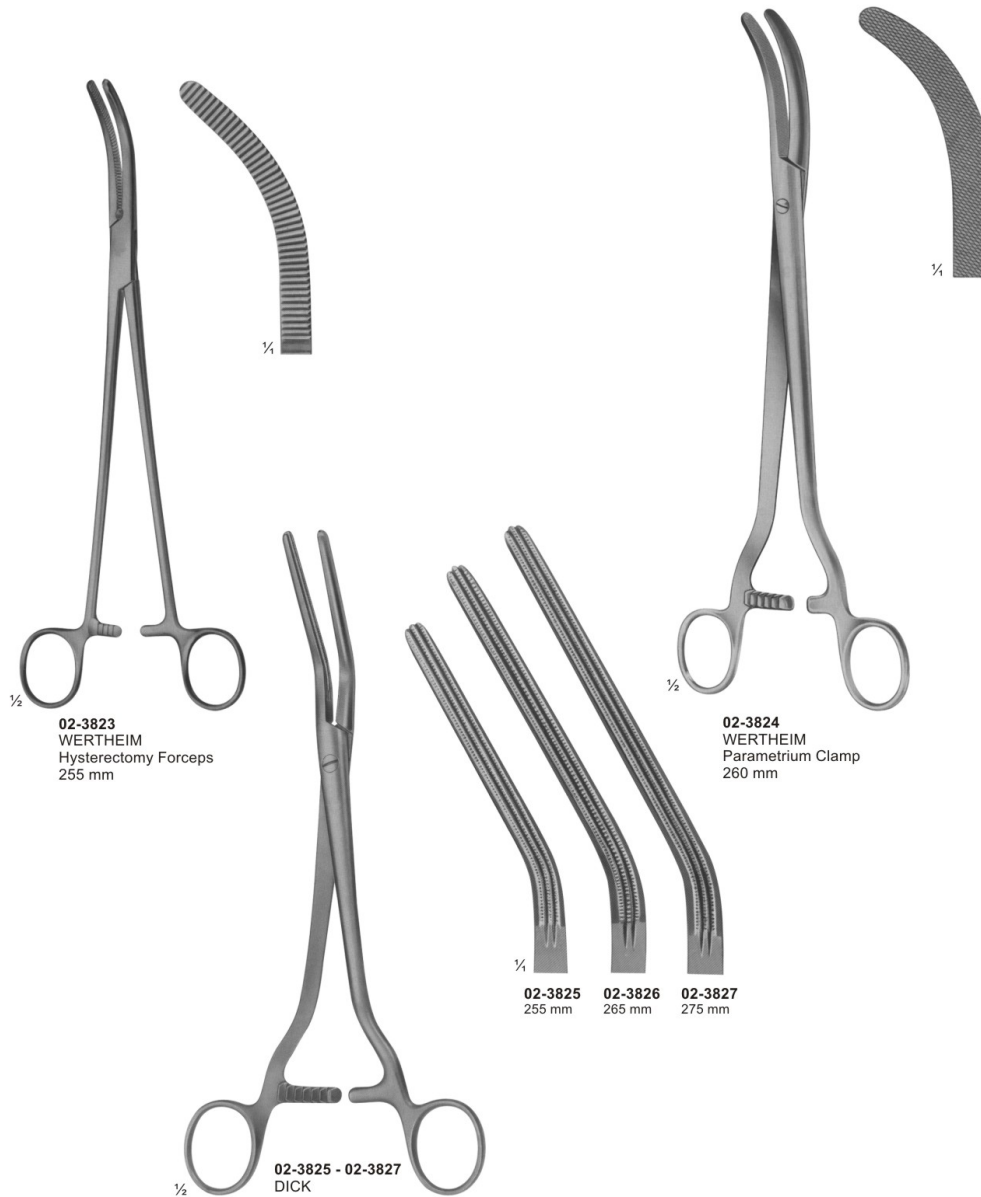

Clamps and Compression Forceps

ATRAUMATA



02-3828
WERTHEIM
250 mm

1/2

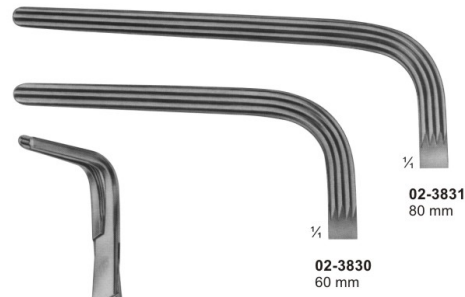

02-3831
80 mm

02-3830
60 mm



02-3829
WERTHEIM-CULLEN
215 mm

1/4



02-3830 - 02-3831
230 mm

1/2

Needle Holders For Micro Surgery



02-3832
ROHRSCHEIDER
With copper inserts
100 mm



02-3833
KALT
With catch
135 mm



02-3834
ARRUGA
With catch
135 mm



02-3835 - 02-3836
CASTROVIEJO
With catch
145 mm



02-3837 - 02-3838
CASTROVIEJO
With Catch
160 mm



02-3839 - 02-3840
Without catch
185 mm



02-3840



02-3841 - 02-3842
JACOBSON
185 mm



02-3841
Without catch



02-3842
With catch



02-3843
Without catch
195 mm



02-3844 - 02-3845
YASARGIL
With catch
200 mm



02-3844



02-3845

**Micro Needle Holders With Round Handles
and Bayonet - Shaped**

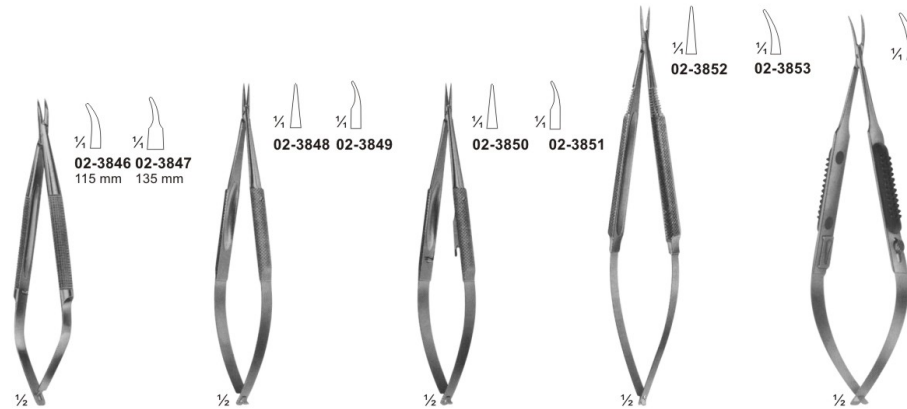

02-3846 - 02-3847
BARRAQUER
Without catch
115 mm 135 mm

02-3848 - 02-3849
BARRAQUER
Without catch
120 mm

02-3850 - 02-3851
BARRAQUER
With catch
120 mm

02-3852 - 02-3853
With Catch
150 mm

02-3854
MULLER
With Locking
Mechanism
145 mm



02-3855 - 02-3856
BROCK
Without catch
150 mm

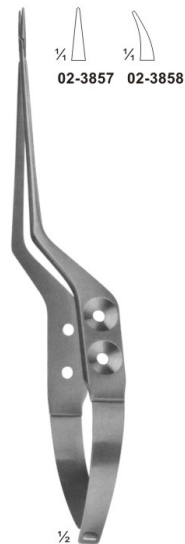

02-3857 - 02-3858
YASARGIL
200 mm



02-3859 - 02-3860
YASARGIL
225 mm



02-3861
YASARGIL
245 mm

Needle Holders

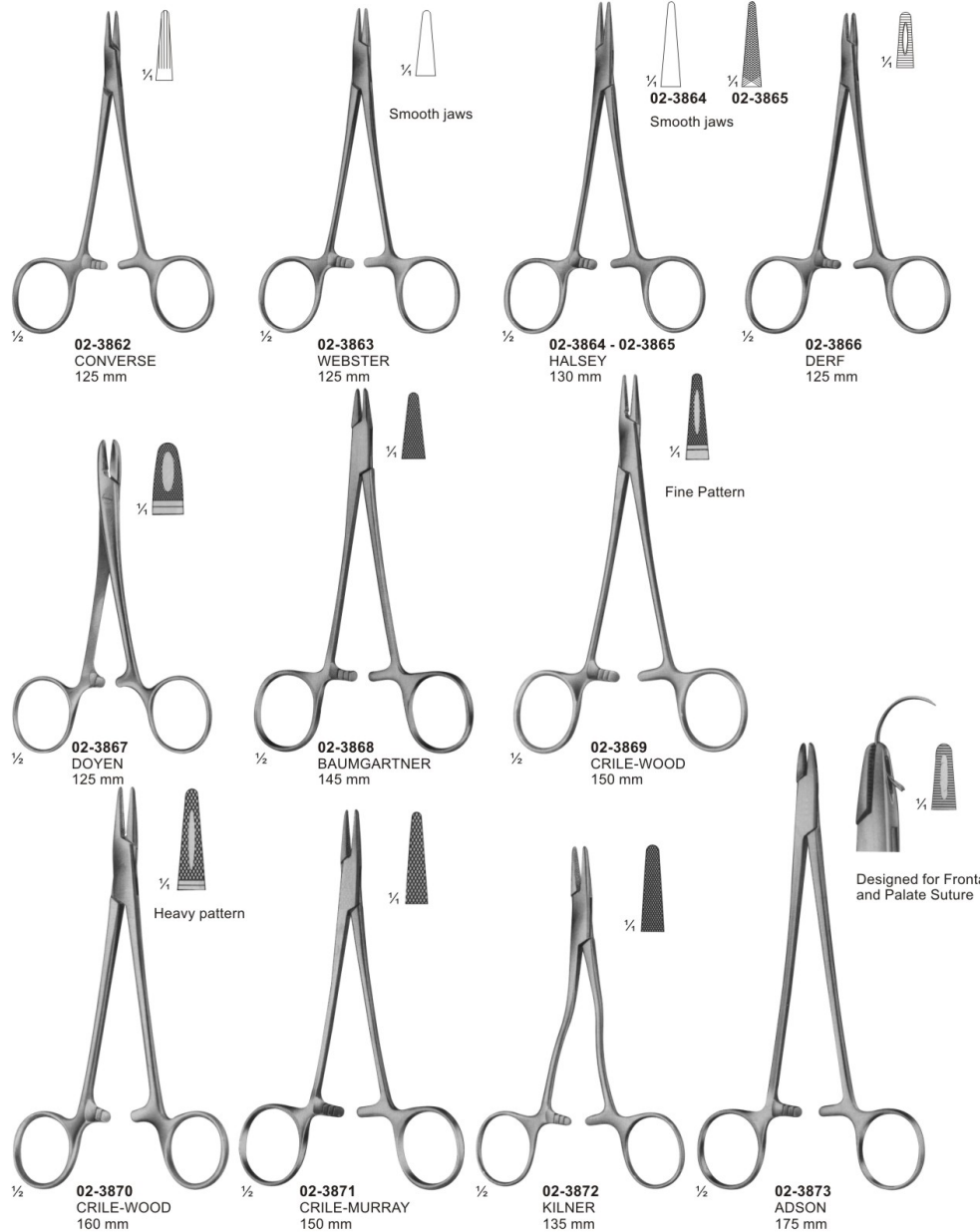

Needle Holders



02-3874 - 02-3876
MAYO-HEGAR
Medium fine patterns

02-3877 - 02-3880
HEGAR
Heavy Patterns

02-3881
HEANEY (HEGAR)
200 mm



02-3882
JAMESON
230 mm

02-3883
WANGENSTEEN
275 mm

02-3884
MASSON
265 mm

02-3885
MASSON-LUETHY
255 mm

Needle Holders

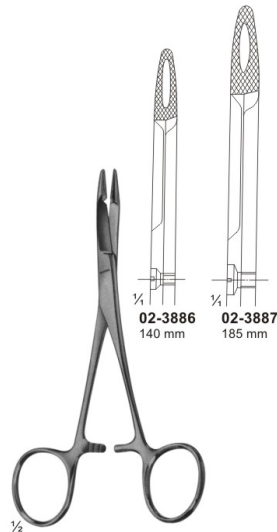

02-3886 - 02-3887
HEGAR-OLSEN
Needle Holders with Scissors

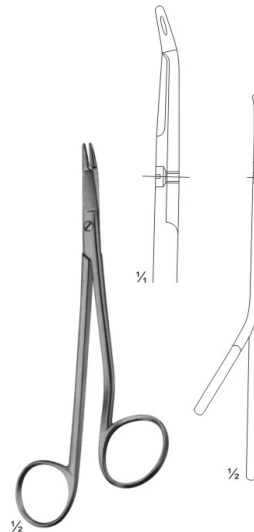

02-3888
GILLIES
Needle Holders with Scissors
150 mm

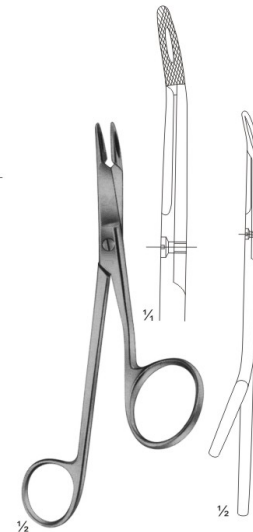

02-3889
GILLIES
Needle Holders with Scissors
160 mm

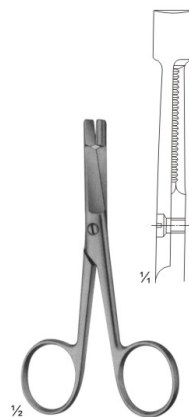

02-3890
EISELSBERG
Needle Holders with Scissors
115 mm

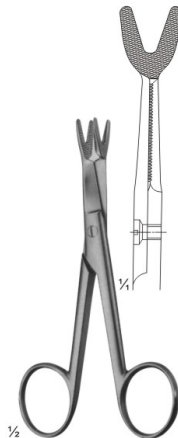

02-3891
SCHOEMAKER-LOTH
Needle Holders with Scissors
125 mm



02-3892
CRILE
150 mm



02-3893
TOENNIS
Elastic pattern for
dura-or intestinal suture
180 mm

Needle Holders

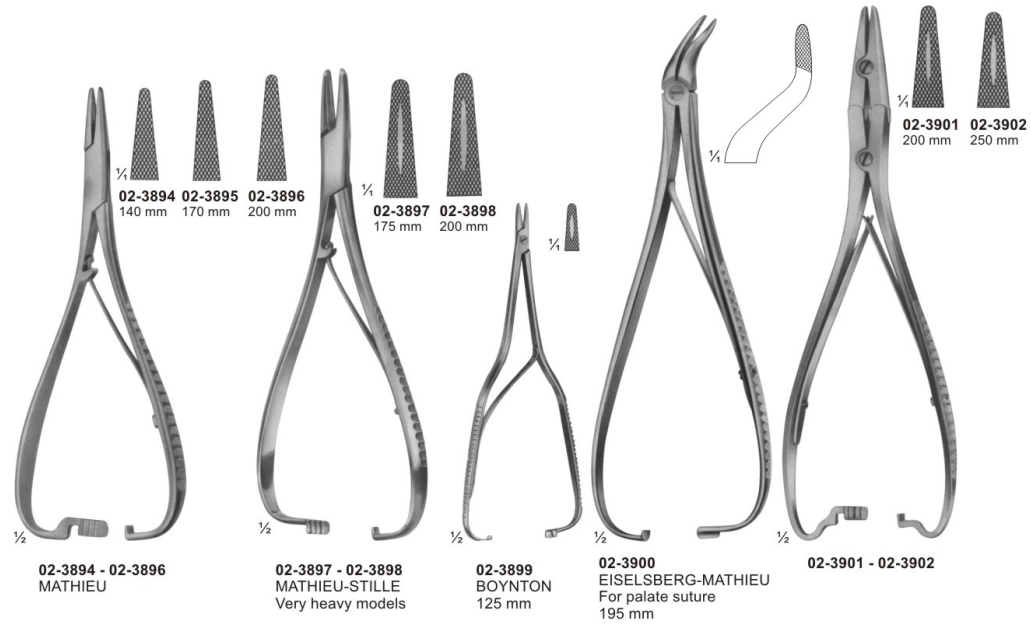

Spare Needles

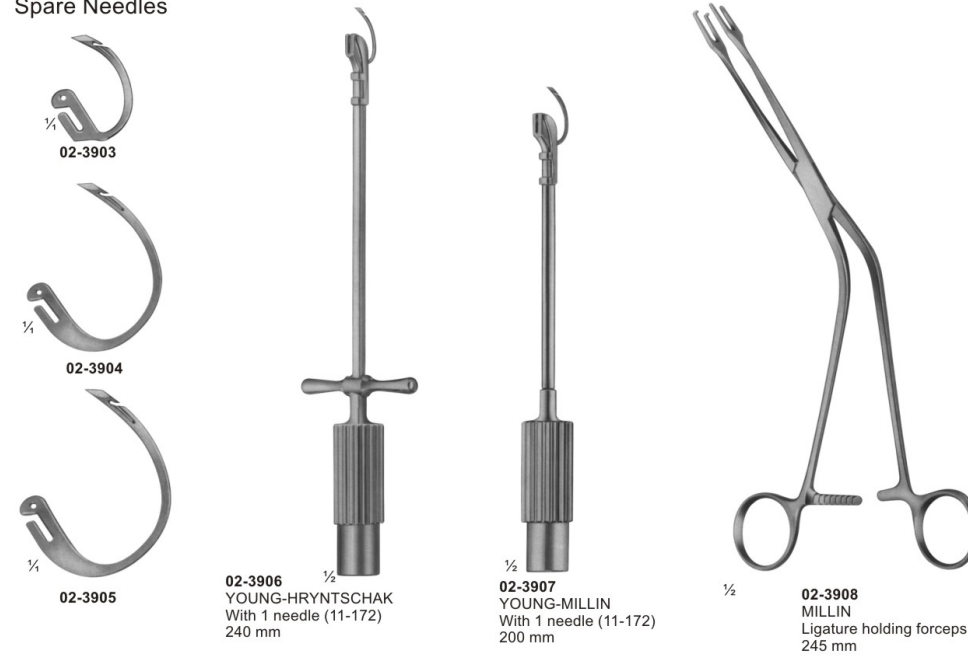

Suture Instruments - Reverdin Needles

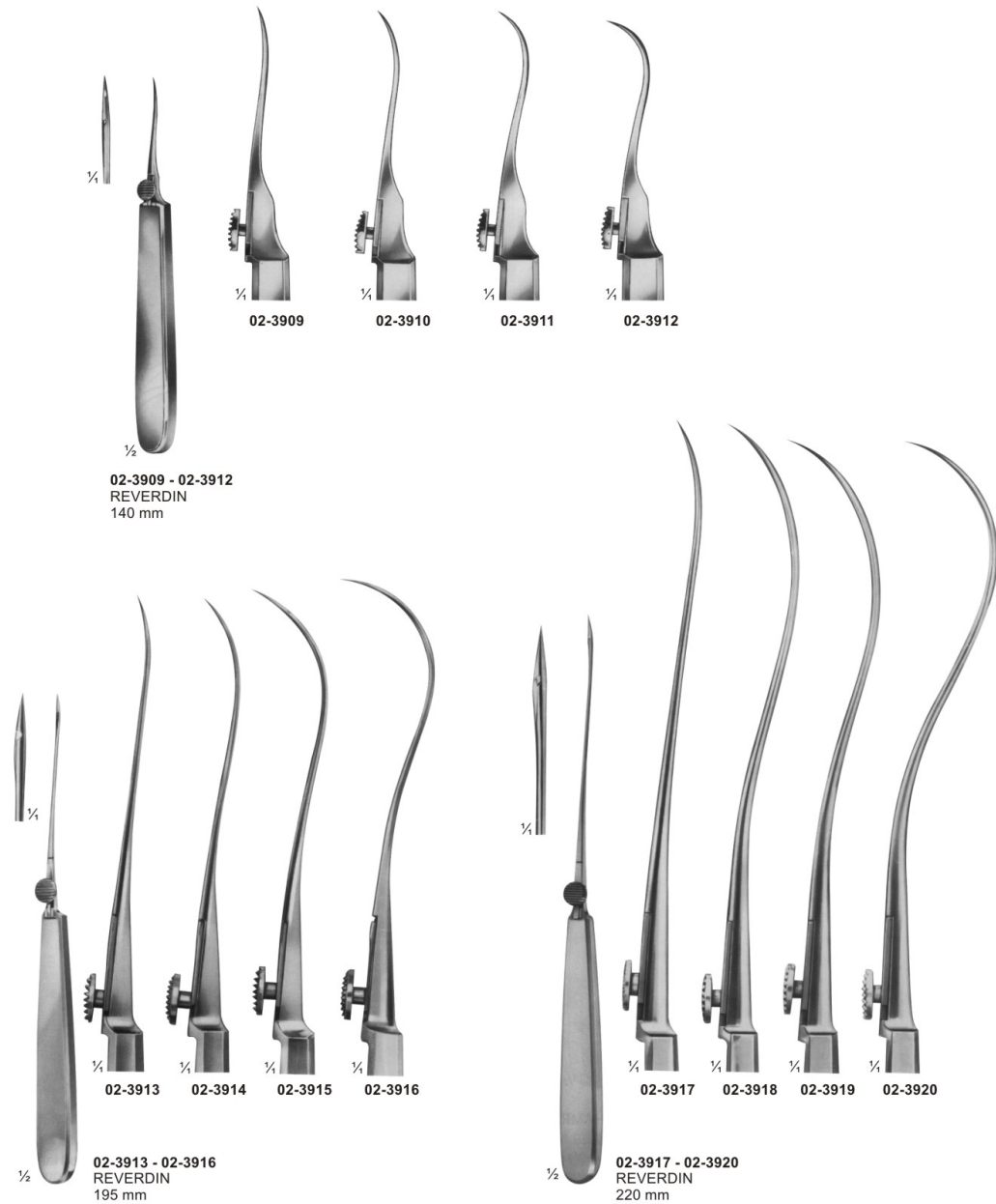

Suture Instruments - Ligature Needles

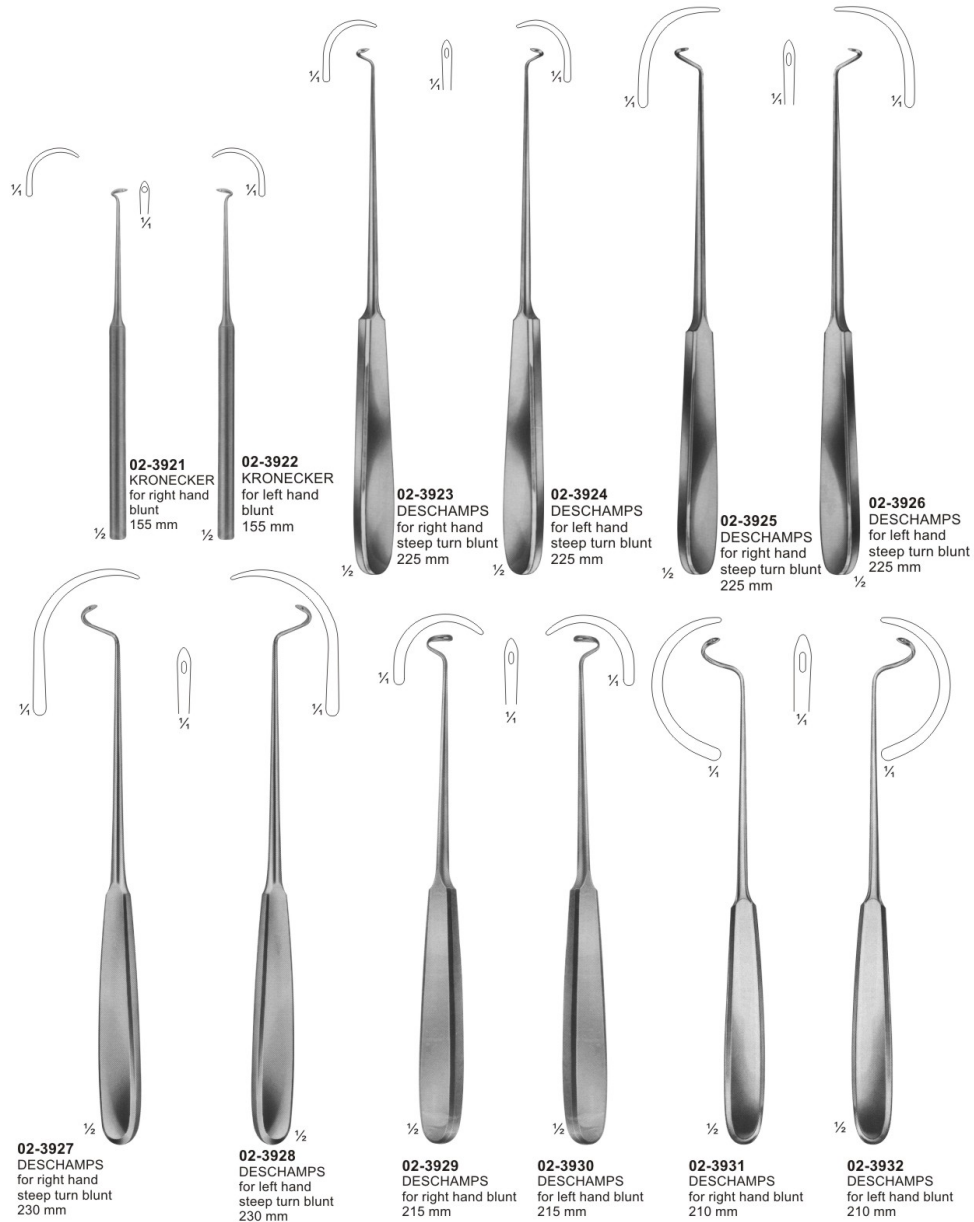

Suture Instruments - Ligature Needles



1/4
02-3933
HURD
for right hand
sharp
210 mm



1/4
02-3934
HURD
for left hand
sharp
210 mm

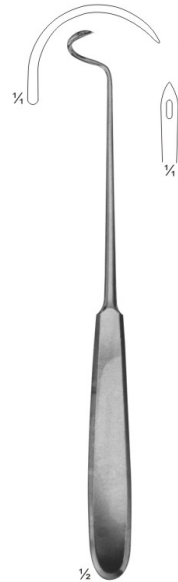

1/4
02-3935
DESCHAMPS
for right hand
sharp
215 mm



1/4
02-3936
DESCHAMPS
for left hand
sharp
215 mm



1/4
02-3937
JONESCO
Needle for wire suture
185 mm



1/4
02-3938
CLAUS VAN EICKEN
Needle for wire suture
250 mm

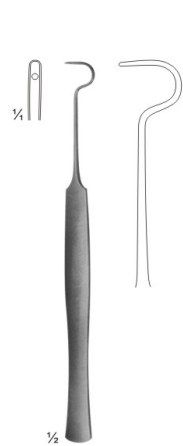

1/4
02-3939
150 mm

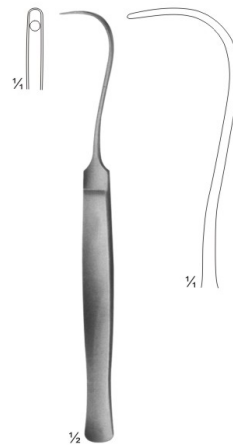

1/4
02-3940
SYME
170 mm

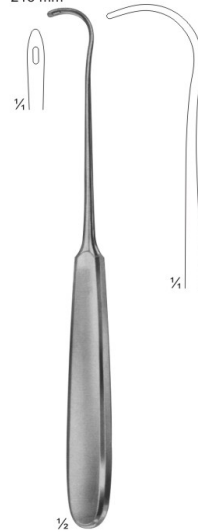

1/4
02-3941
COOPER
205 mm

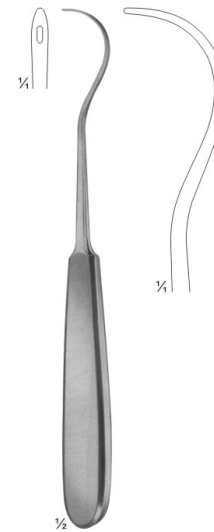

1/4
02-3942
KOCHER
205 mm

Ligature Needles

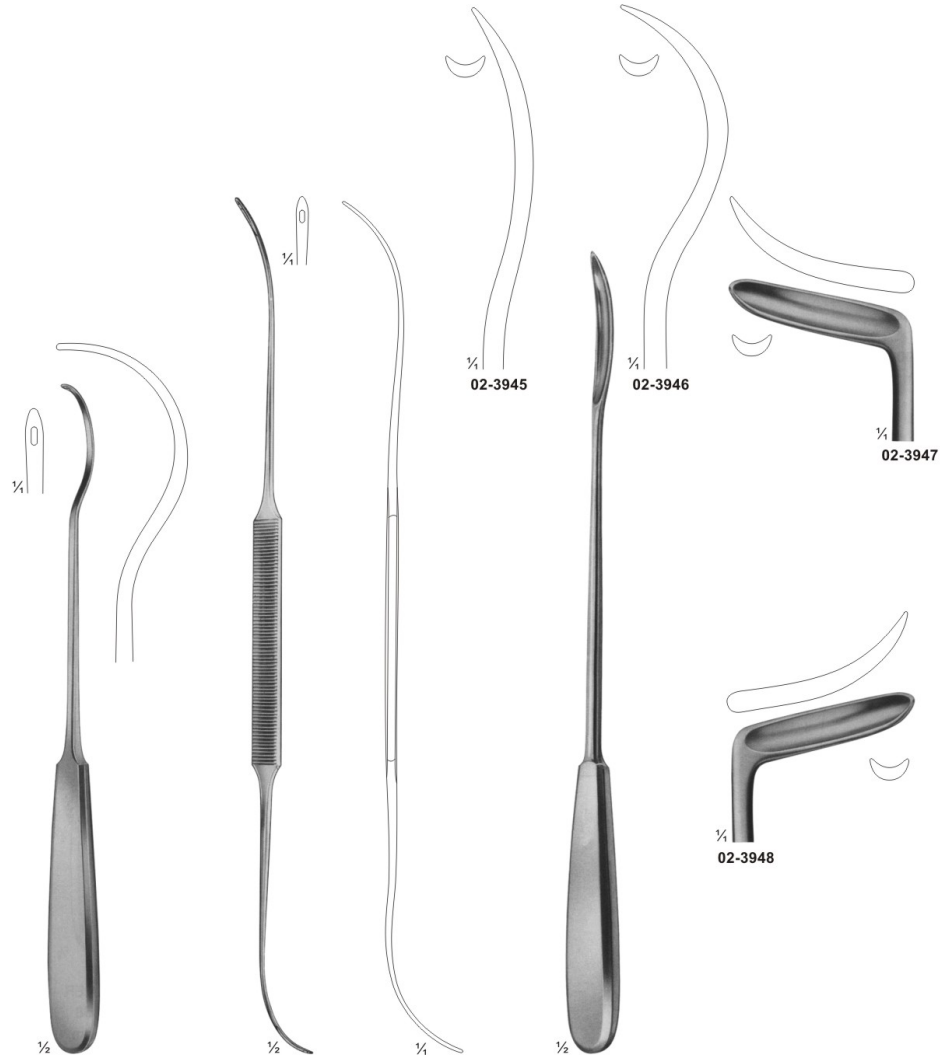

02-3943
BRUNNER
240 mm

02-3944
SCHMIEDEN-DICK
Malleable / Flexible
320 mm

02-3945 - 02-3946
BRUNNER
Guiding Probes
300 mm

Guiding Probes and Suture Instruments

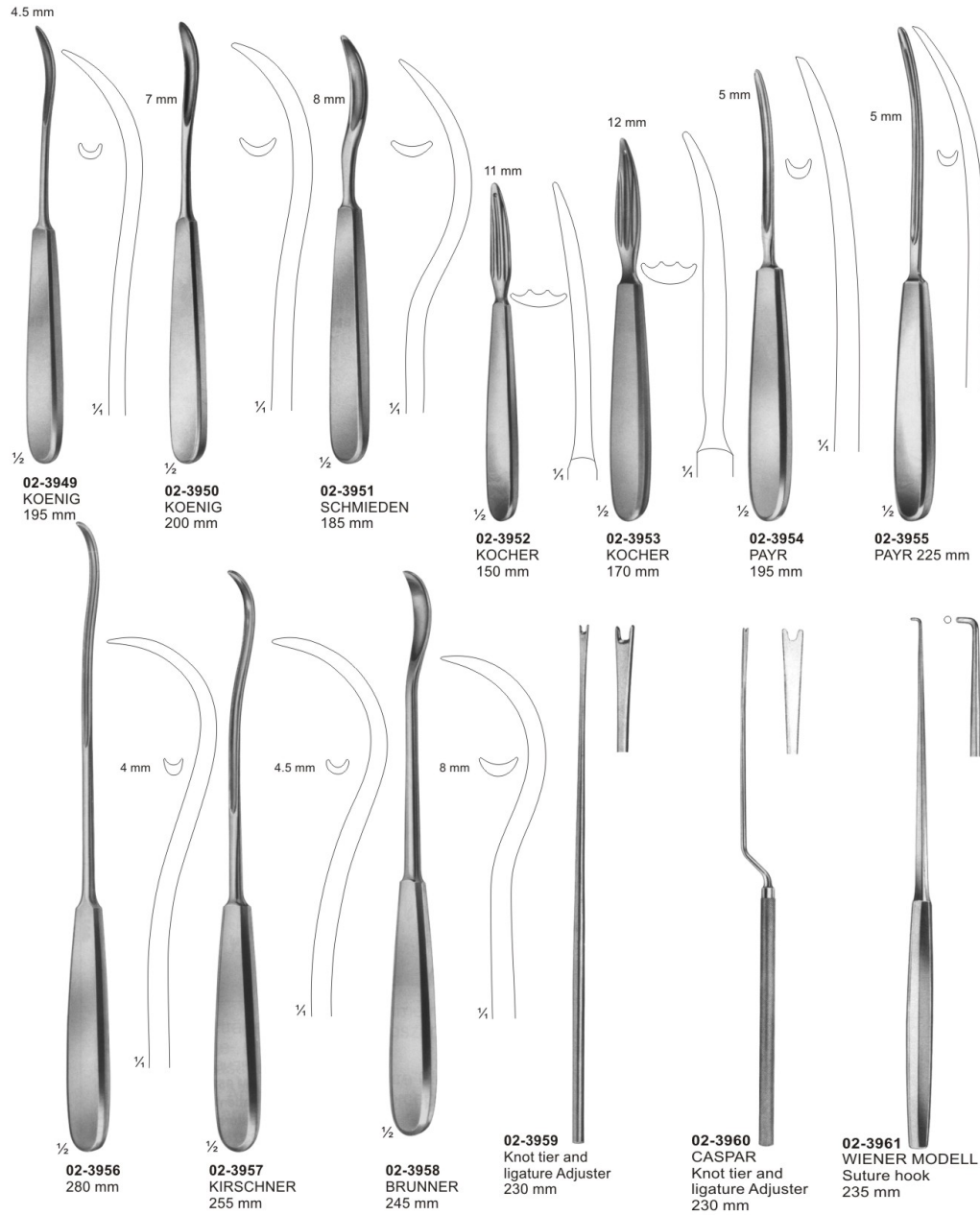

Directors and Probes

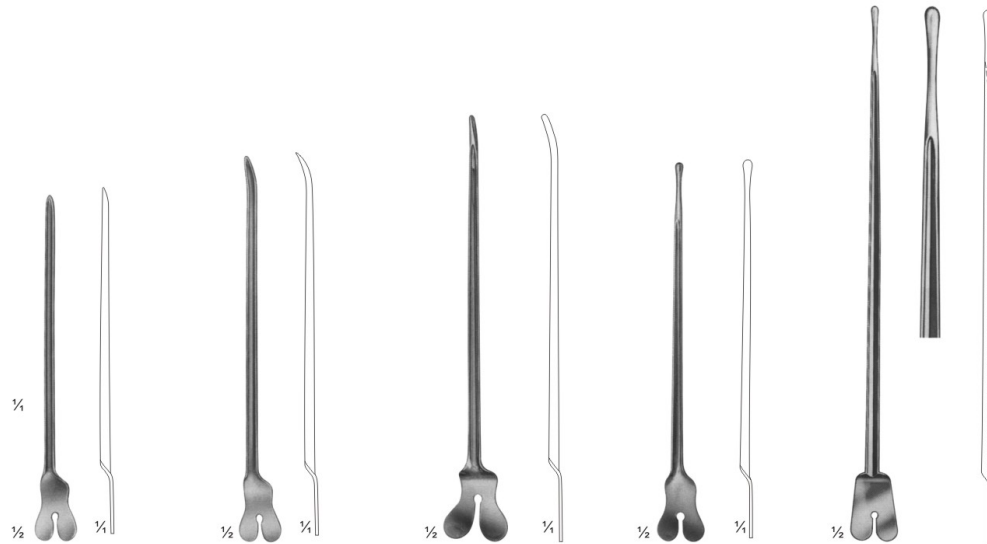

02-3962 - 02-3964
02-3962 130 mm
02-3963 145 mm
02-3964 160 mm
Directors

02-3965
DOYEN
145 mm
Directors

02-3966
NELATON
160 mm
Directors

02-3967
Director with tip
Diam. Of tip 3,3 mm
140 mm

02-3968
BRODIE
Director with tip,
Diam. Of tip 3,5 mm
200 mm

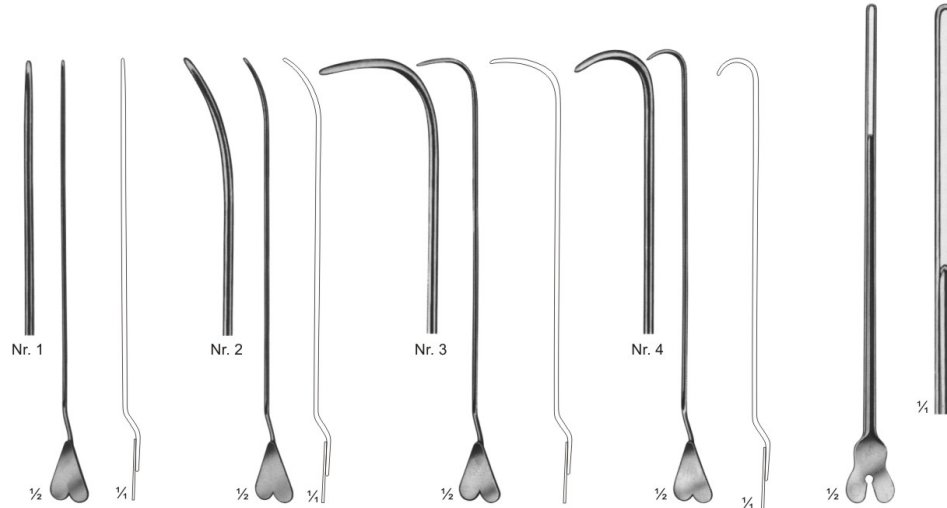

02-3969
LOCKHART-MUMMERY
165 mm
Straight

02-3970
LOCKHART-MUMMERY
165 mm
45° Curved

02-3971
LOCKHART-MUMMERY
165 mm
90° Curved

02-3972
LOCKHART-MUMMERY
165 mm
Retrograde Curved

02-3973
Director with wire
loop, malleable
190 mm

Probes

02-3974
2,5 mm Ø
02-3975
2,5 mm Ø
02-3976
3,0 mm Ø



1/2

02-3974 - 02-3976
02-3974 145 mm
02-3975 160 mm
02-3976 200 mm
Probes with eye

1,5 mm Ø



1/2

02-3977
Myrtle leaf probe
145 mm

2,0 mm Ø



1/2

02-3978 - 02-3982
Myrtle leaf probe
02-3978 130 mm
02-3979 145 mm
02-3980 160 mm
02-3981 180 mm
02-3982 200 mm

diam. of tips		length
1 mm	1,5 mm	2 mm
-	02-3984	-
02-3985	02-3986	02-3991
-	02-3987	02-3992
-	02-3988	02-3993
-	02-3989	02-3994
-	02-3990	-
-	-	02-3995

02-3983
Probes



1/2

02-3996
Double ended probe,
malleable, diam. of tips
3 mm with hole
190 mm



02-3997
250mm 300mm
Double ended probes,
tin, malleable, diam. of tips
3,5 mm with hole



3/4

02-3998
Double ended probe,
tin, malleable,
diam. of tips 4 mm
400 mm



1/2

Ø tip
02-3999 - 02-4001
02-3999 1,5 mm
02-4000 2,0 mm
02-4001 2,5 mm
300 mm Probes

Probes - Spatulas - Cotton Applicators

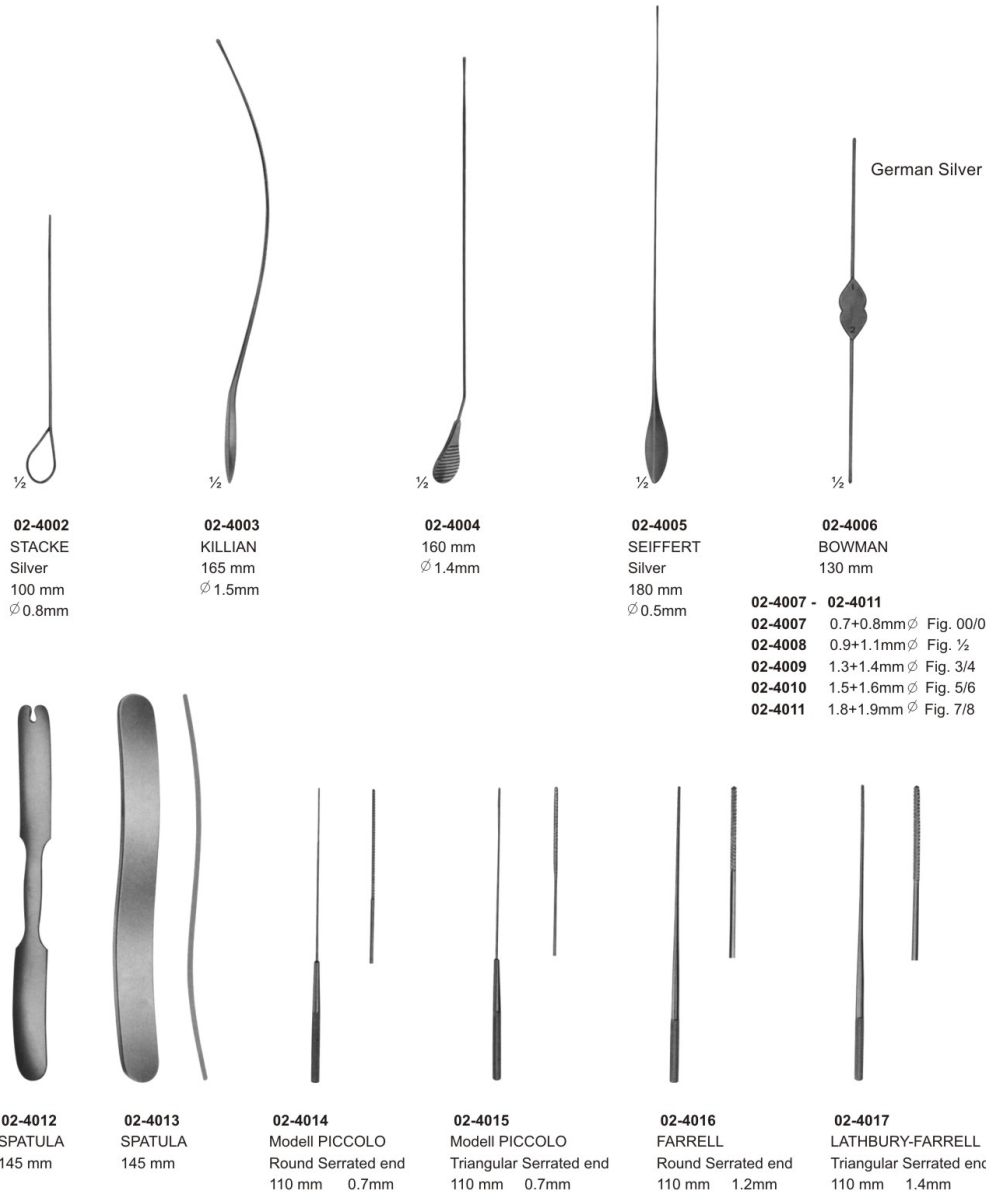

Cotton Applicators

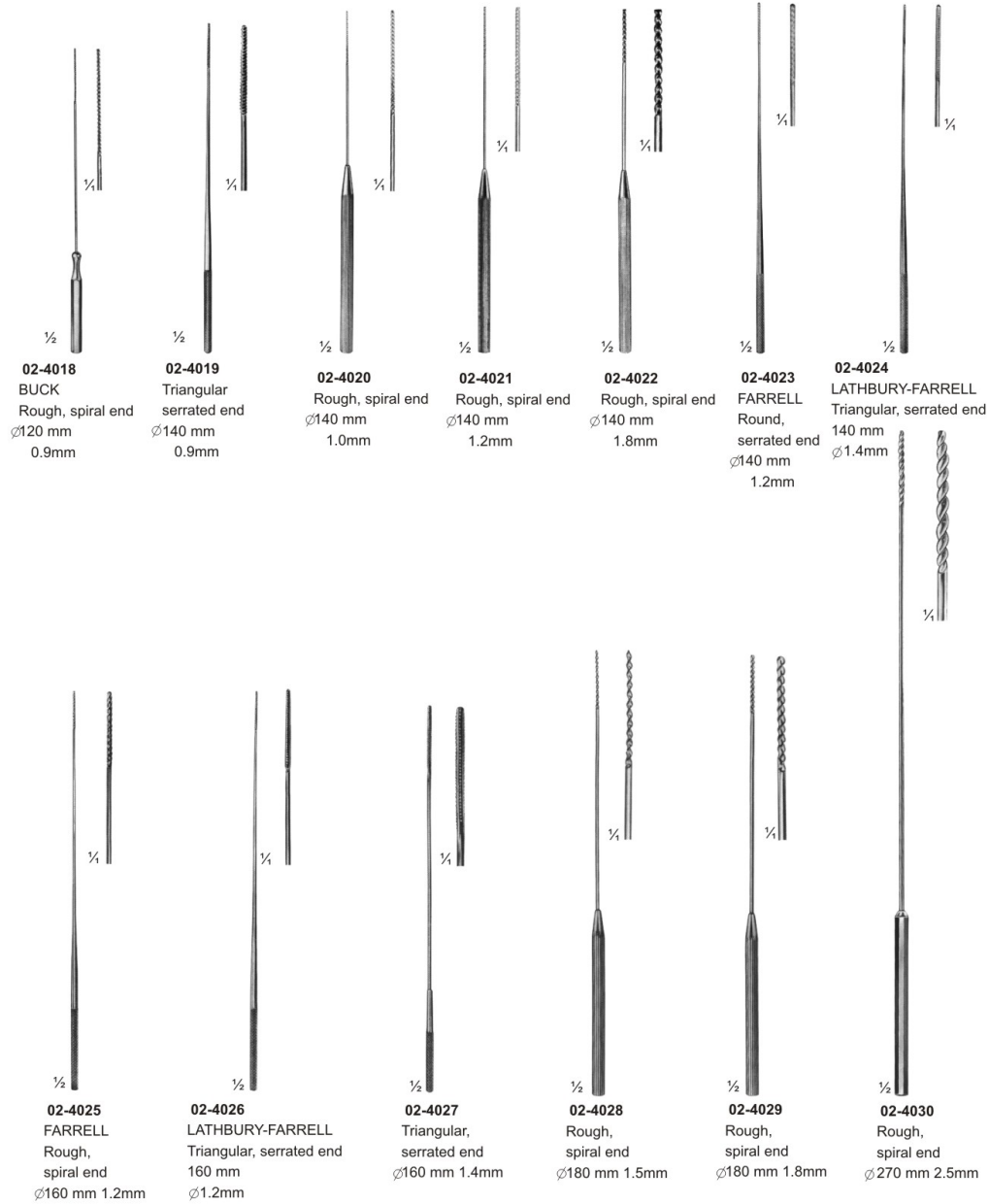

02-4018
BUCK
Rough, spiral end
∅120 mm
0.9mm

02-4019
Triangular
serrated end
∅140 mm
0.9mm

02-4020
Rough, spiral end
∅140 mm
1.0mm

02-4021
Rough, spiral end
∅140 mm
1.2mm

02-4022
Rough, spiral end
∅140 mm
1.8mm

02-4023
FARRELL
Round,
serrated end
∅140 mm
1.2mm

02-4024
LATHBURY-FARRELL
Triangular, serrated end
140 mm
∅1.4mm

02-4025
FARRELL
Rough,
spiral end
∅160 mm 1.2mm

02-4026
LATHBURY-FARRELL
Triangular, serrated end
160 mm
∅1.2mm

02-4027
Triangular,
serrated end
∅160 mm 1.4mm

02-4028
Rough,
spiral end
∅180 mm 1.5mm

02-4029
Rough,
spiral end
∅180 mm 1.8mm

02-4030
Rough,
spiral end
∅270 mm 2.5mm

**Clip Applying Forceps, Clip Applying - and
Removing Forceps**



½

02-4031
MICHEL
125 mm



½

02-4032
HEGENBARTH
120 mm



½

02-4033
WACHENFELDT
120 mm



½

02-4034
WACHENFELDT
120 mm



½

02-4035
MICHEL
125 mm



½

02-4036
MICHEL modif.
130 mm



½

02-4037
HEATH
135 mm



½

02-4038
COLLIN
135 mm

Suturing Instrument Set, Pocket Instrument Set

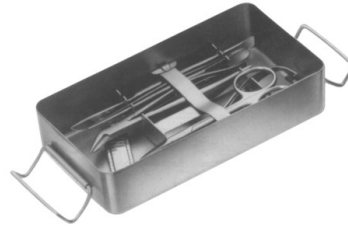

02-4039

Suturing instruments set, in metal case consisting of:

- 1 michel clip applying and removing forceps,
- 1 Scissors, curved, sharp/sharp, 115mm
- 25 MICHEL clips, 16 x 3mm 1 Delicate tissue forceps, 130mm
- 1 Scalpel, bellied 1 MATHIEU needle holder, 140mm
- 1 Perforated metal case, stainless

containing:

- 1 Suture needle
- 1 Suture needle
- 1 Suture needle



02-4040

Pocket instrument set, in metal case consisting of:

Bottom tray

- 1 MATHIEU needle holder, 140mm
- 1 MICHEL clip forceps, combined
- 1 Myrtle leaf probe, 130mm
- 1 Sharp double curette
- 1 Skin hook
- 1 Detachable scalpel handle, no.4
- 1 Perforated metal case, containing
- 6 Scalpel blades
- 1 Perforated metal case, stainless, containing
- 1 Suture needle
- 1 Suture needle
- 1 Suture needle

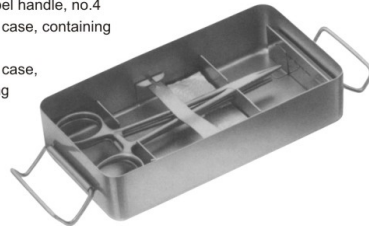

02-4041

Pocket instrument set, in metal case consisting of:

Bottom tray

- 1 MAYO-HEGER needle holder, 150mm
- 1 MICHEL clip forceps, combined 1 Myrtle leaf probe, 130mm
- 1 Sharp double curette 1 Skin hook 1 Detachable scalpel handle, no. 4
- 1 Perforated metal case, consisting
- 6 Scalpel blades
- 1 Perforated metal case, stainless, consisting:
- 1 Suture needle
- 1 Suture needle
- 1 Suture needle

Top tray

- 1 Tissue forceps, 130mm
- 1 KOCHER haemostatic forceps, 130mm
- 1 Straight surgical scissors, 130mm
- 1 Dissecting forceps, 130mm
- 1 FEILCHENFELD splinter forceps, 115mm
- 25 MICHEL clip, 16 x 3mm
- 1 Flacon of suture skin, sterile in alcohol

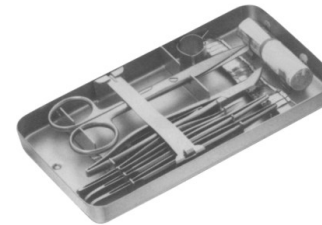

Top tray

- 1 Tissue forceps, 130mm
- 1 CRILE haemostatic forceps, 140mm
- 1 Straight surgical scissors, 130mm
- 1 Dissecting forceps, 130mm
- 1 FEILCHENFELD splinter forceps, 115mm
- 25 MICHEL clip, 16 x 3mm
- 1 Flacon of suture silk, sterile in alcohol

Pocket Instrument Set, Venae Sectio Set

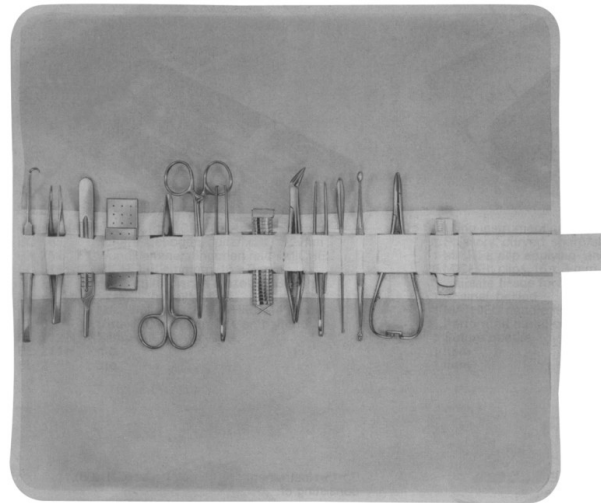

02-4042

Pocket instrument set in metal case 170 x 90mm
canvas roll only, sterilizable in autoclave.

consisting of:

- 1 Myrtle leaf probe, 130mm
- 1 Sharp double curette
- 1 FEILCHENFELD splinter forceps, 115mm
- 1 Dissecting forceps, 130mm
- 1 Tissue forceps, 130mm

- 1 Straight surgical scissors, 130mm
- 1 Scalpel handle no. 4
- 1 Perforated metal case, consisting of 6 scalpel blades
- 1 KOCHER haemostatic forceps, 130mm
- 1 Skin hook
- 1 MATHIEU needle holder, 140mm
- 1 Tube of suture skin, sterile in alcohol
- 1 MICHEL clip forceps, 120mm



- 25 MICHEL clip, 16 x 3mm
- 1 Perforated metal case, stainless, consisting of:
- 1 Suture needle
- 1 Suture needle
- 1 Suture needle

02-4043

Canvas roll only, sterilizable in autoclave

Suitable Metal Cases

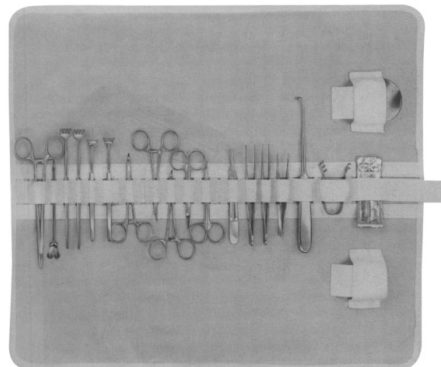

02-4044

Venae sectio set, canvas roll only, sterilizable in autoclave.

consisting of:

- 2 Tissue forceps, 1 x 2 teeth, 140mm
- 1 Dissecting forceps, 145mm
- 1 FEILCHENFELD splinter forceps, 115mm
- 1 Curved scissors, blunt, 115mm
- 3 HALSTED mosquito forceps, curved on flat, 125mm
- 1 Straight scissors, sharp, 110mm

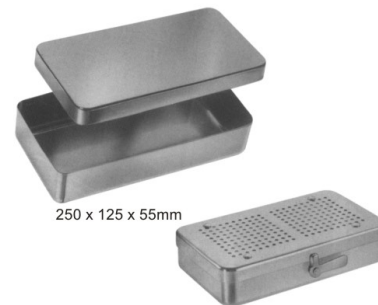

250 x 125 x 55mm

- 1 DESCHAMPS needle, blunt, 210mm
- 1 DOYEN Director, curved, 140mm
- 2 Wound retractors, 4 blunt prongs, 160mm
- 2 DESMARRES wound retractors, 135mm
- 1 FINSSEN retractors, 2 x3 blunt prongs, 80mm
- 1 Scalpel handle no. 4
- 4 Sterile scalpel blades, no 18, single peel pack
- 1 Needle box, perforated, round, diam. 65mm
- 1 HEGAR-MAYO DUROGRIP needle holder, 180mm

02-4045

Canvas roll only, sterilizable in autoclave

Venae Sectio Set

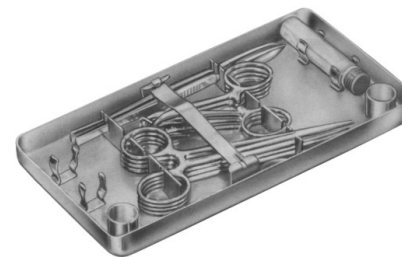
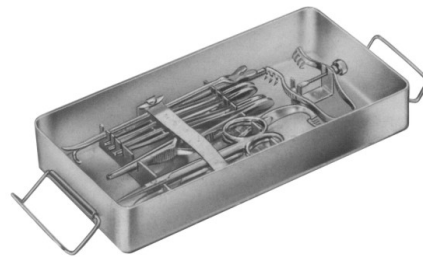

02-4046

Venae sectio set, in metal case
consisting of:

Bottom tray

- 1 MATHIEU needle holder, fine pattern 140mm
- 1 Ligature needle, fine short pattern
- 1 DOYEN director, curved
- 1 HEGENBARTH clip forceps,
- 1 ELSCHNIG tissue forceps, 1 x 2 teeth fine, 105mm
- 1 Dressing forceps, fine 105mm
- 1 Tissue forceps, 1 x 2 teeth, 110mm
- 1 Vessel scissors, straight, with 1 ball point, 110mm
- 1 Vessel scissors, curved, pointed 105mm
- 1 FINSEN retractor
- 1 Perforated needle case

Top tray

- 1 Scalpel, pointed
- 1 Scalpel, bellied
- 2 HALSTED mosquito forceps, curved, 125mm
- 2 HALSTED mosquito forceps, straight, 1x 2 teeth, 125mm
- 3 BACKHAUS towel forceps, 90mm
- 2 Flacon holder

Nerve - and Vessel Hooks

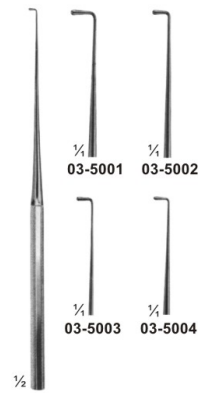

03-5001 - 03-5004
WAGENER
150 mm

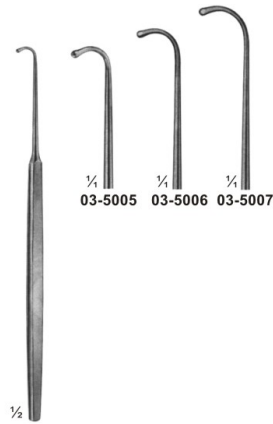

03-5005 - 03-5007
GRAEFE
140 mm



03-5008
BROM
Vein hook
170 mm



03-5009
CRILE
200 mm



03-5010 - 03-5011
CUSHING
190 mm

Nerve - and Vessel Hooks

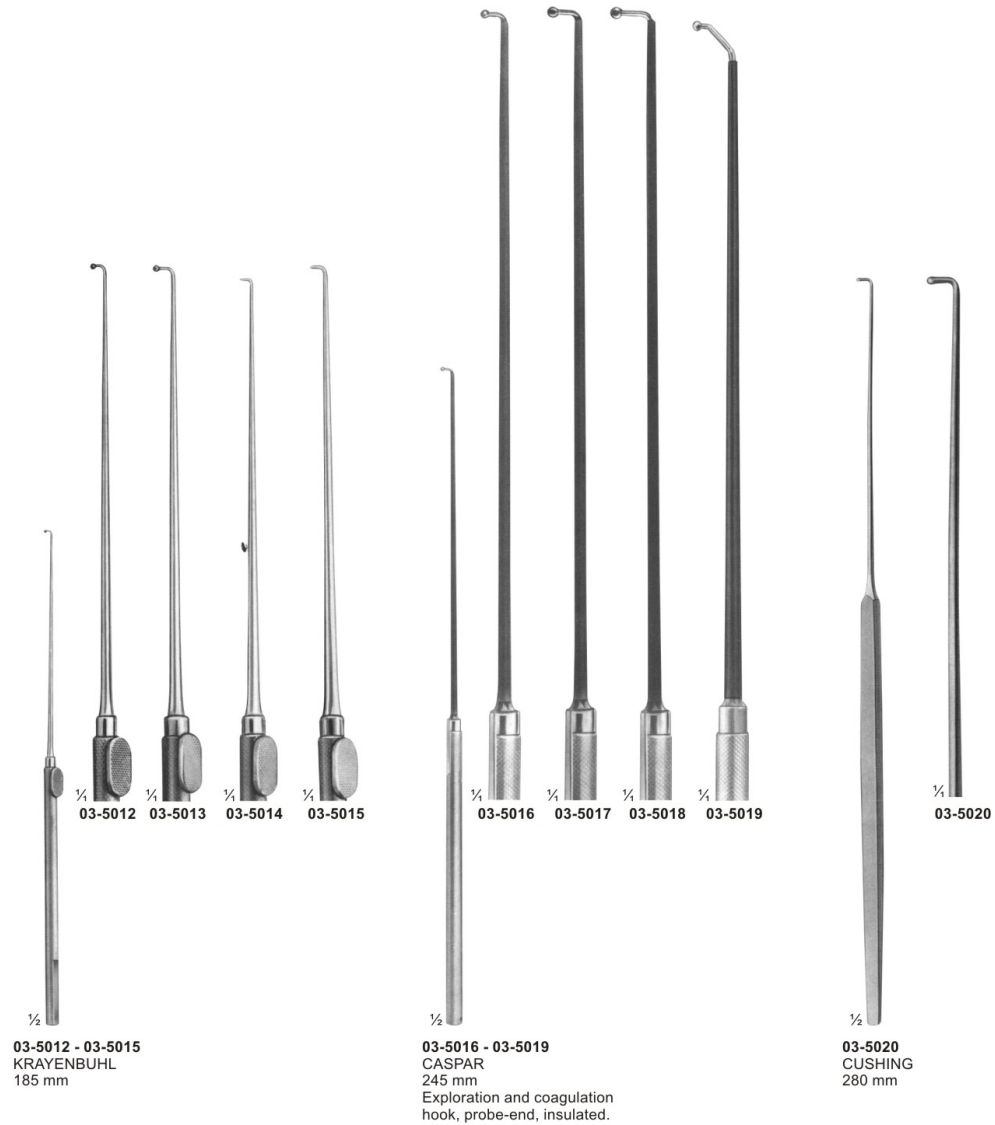

Fine Wound Retractors (Dura- and Skin Retractors)

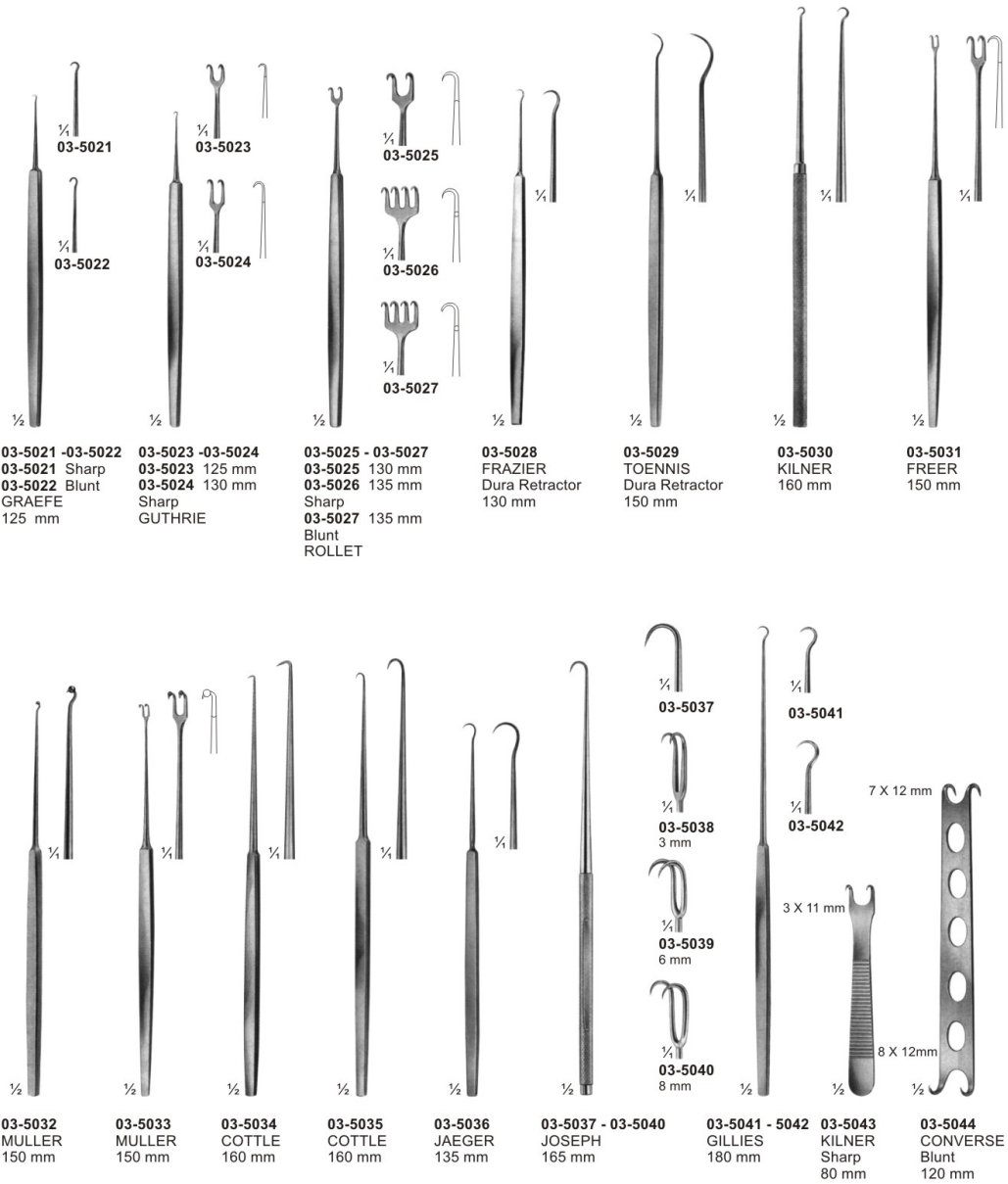

03-5021 - 03-5022
03-5021 Sharp
03-5022 Blunt
GRAEFE
125 mm

03-5023 - 03-5024
03-5023 125 mm
03-5024 130 mm
Sharp
GUTHRIE

03-5025 - 03-5027
03-5025 130 mm
03-5026 135 mm
Sharp
03-5027 135 mm
Blunt
ROLLET

03-5028
FRAZIER
Dura Retractor
130 mm

03-5029
TOENNIS
Dura Retractor
150 mm

03-5030
KILNER
160 mm

03-5031
FREER
150 mm

03-5032
MULLER
150 mm

03-5033
MULLER
150 mm

03-5034
COTTLE
160 mm

03-5035
COTTLE
160 mm

03-5036
JAEGER
135 mm

03-5037 - 03-5040
JOSEPH
165 mm

03-5041 - 5042
GILLIES
180 mm

03-5043
KILNER
Sharp
80 mm

03-5044
CONVERSE
Blunt
120 mm

Wound - Trachea Retractors

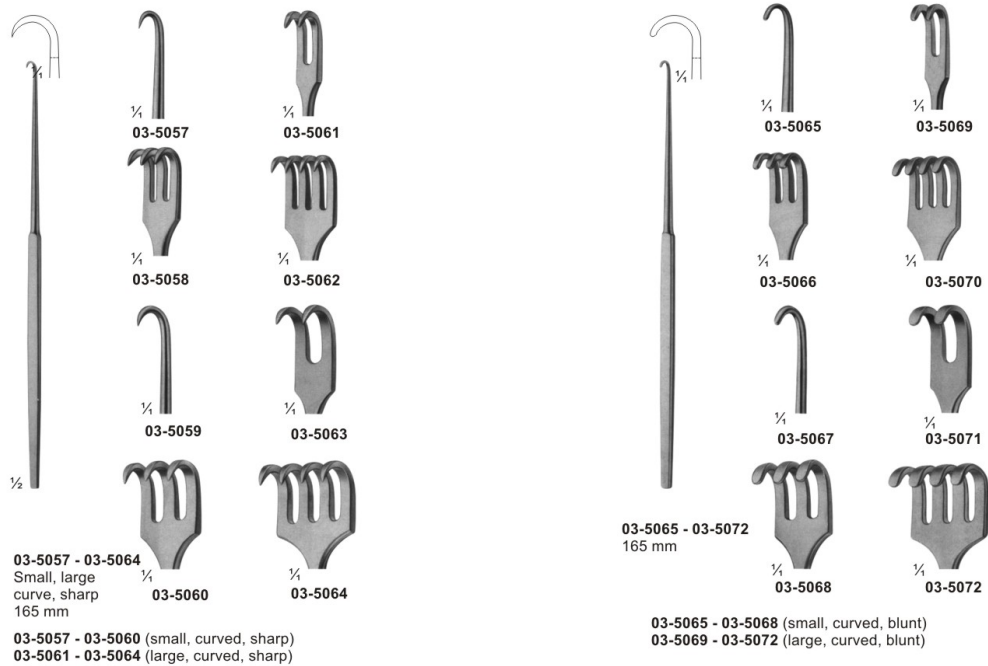

Retractors With Treangle Handle

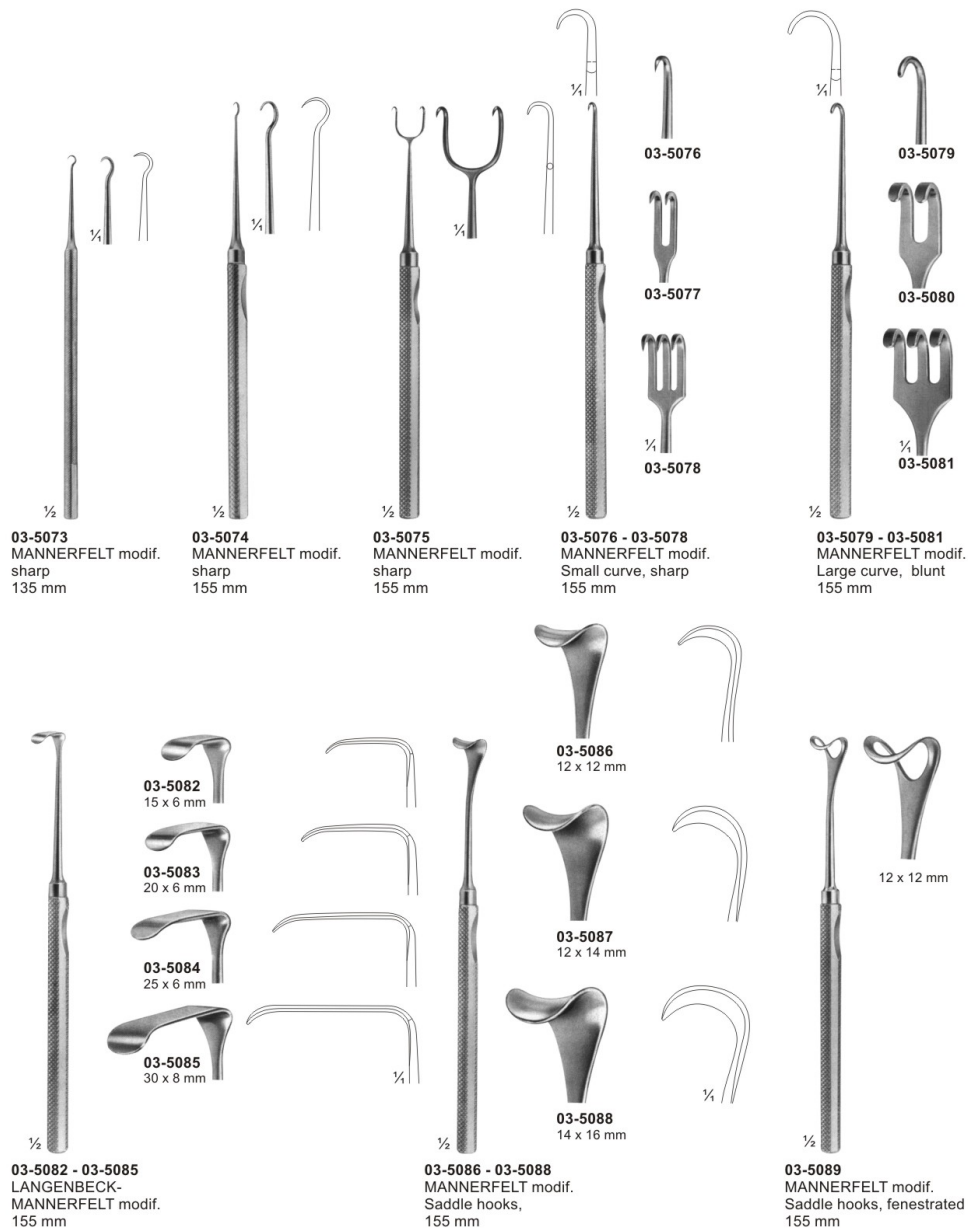

Retractors

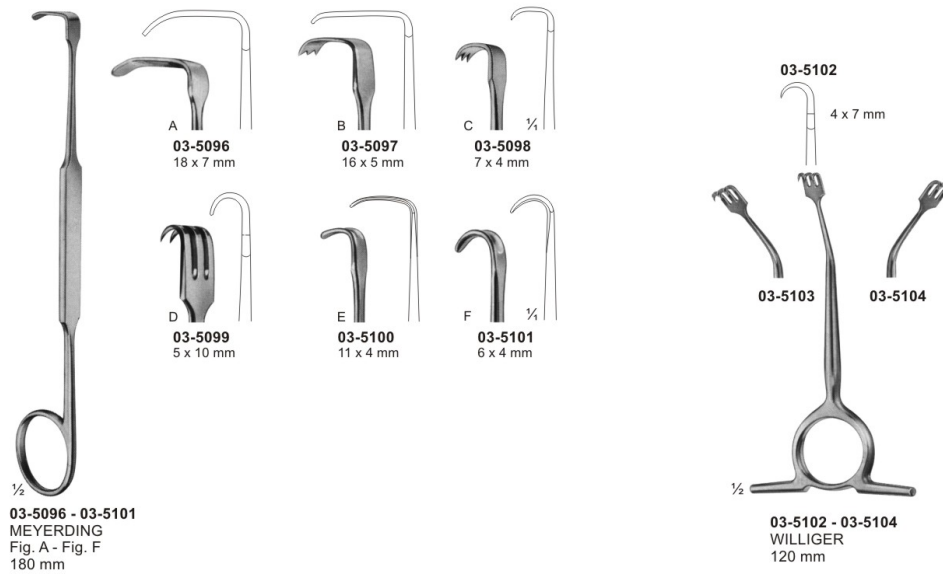

Retractors



03-5105
EMMET
Fistula hook
220 mm

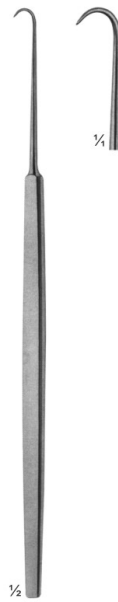

03-5106
SIMON
Fistula hook
220 mm

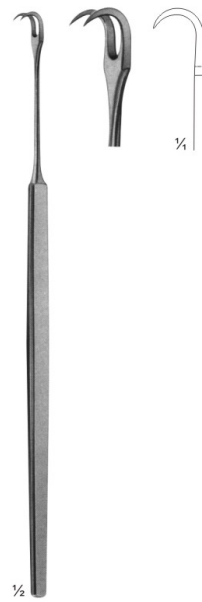

03-5107
SIMON
Fistula hook
220 mm



03-5108
LANGE
Fistula hook
230 mm

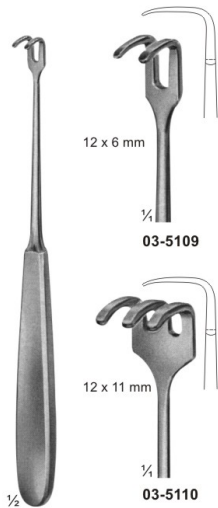

03-5109 - 03-5110
Tendon hooks
175 mm

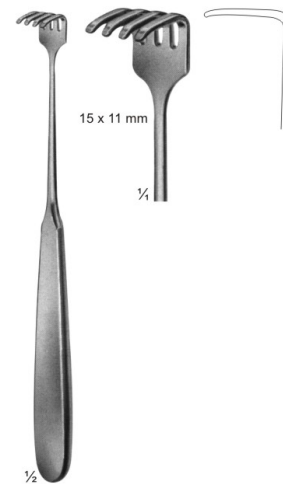

03-5111
KLAPP
Tendon hooks
175 mm

Wound and Vein Retractors

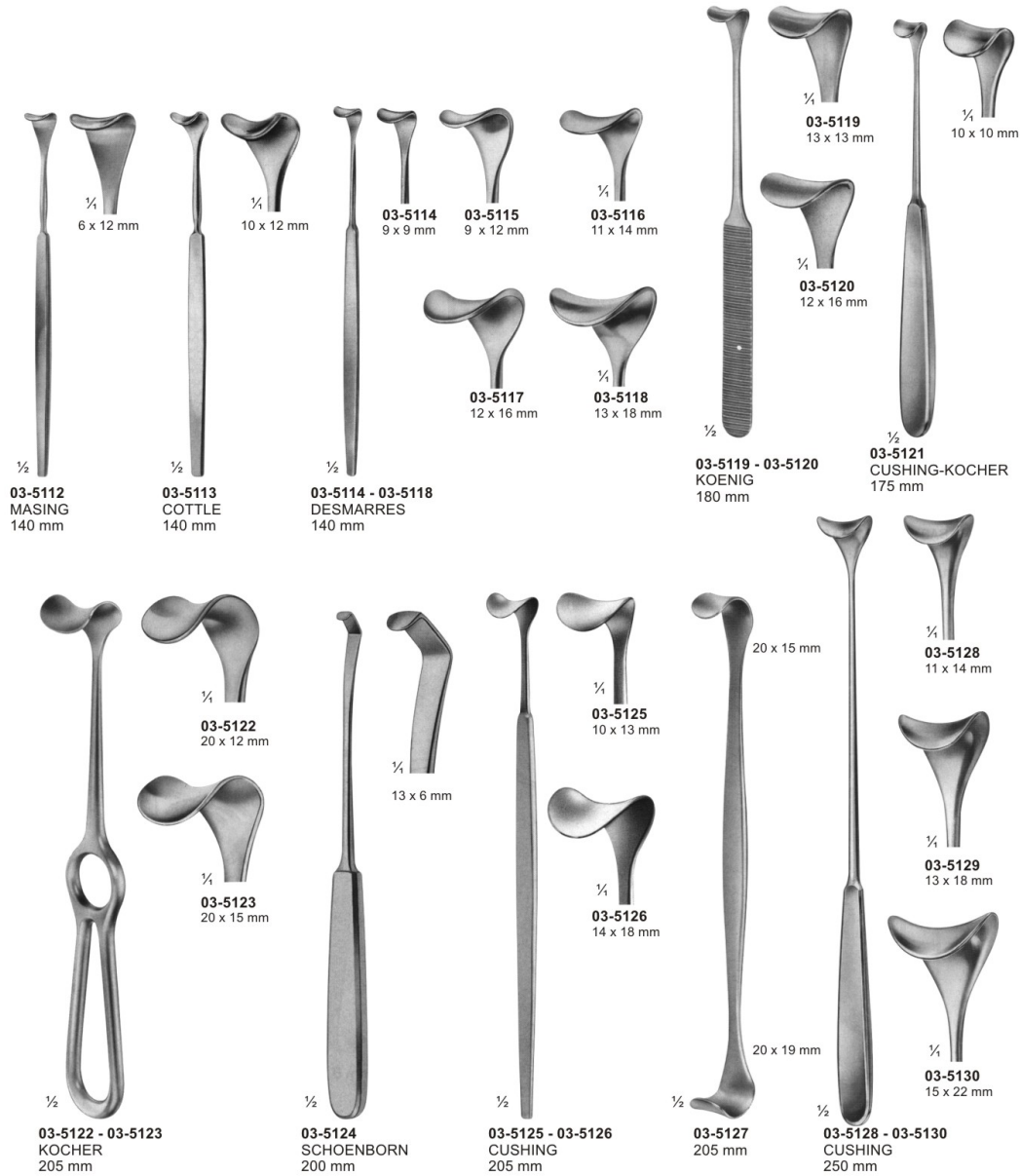

Retractors



Retractors



Bone Retractors and Retractors



03-5155
KOCHER
Sharp
205 mm



03-5156
KOCHER
Sharp
220 mm



03-5157
VOLKMANN
Sharp
220 mm



03-5158
VOLKMANN
Blunt
220 mm



03-5159
VOLKMANN
Sharp
220 mm



03-5160 - 03-5167
VOLKMANN
225 mm



03-5160
9 x 8 mm



03-5161
9 x 13 mm



03-5162
9 x 19 mm



03-5163
9 x 29 mm



03-5164
8,5 x 8 mm



03-5165
8,5 x 13 mm



03-5166
8,5 x 19 mm



03-5167
8,5 x 29 mm

Retractors

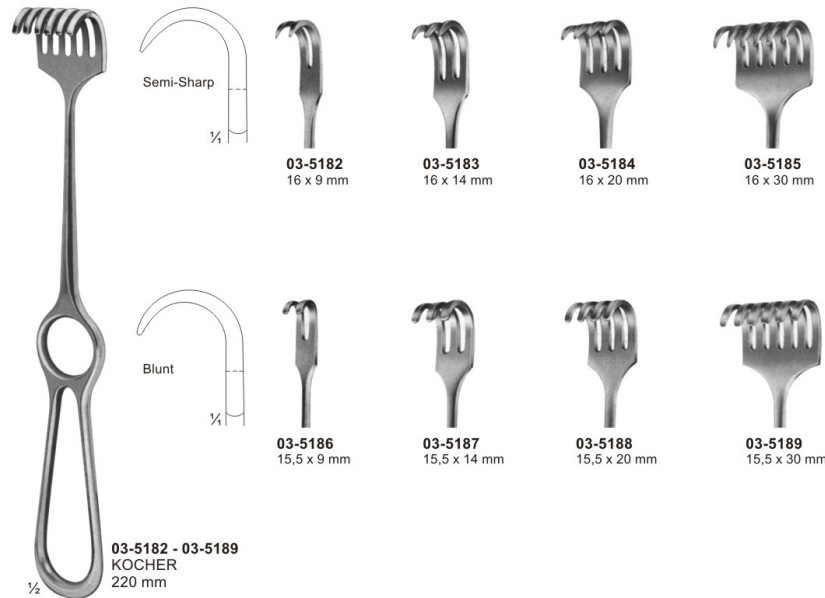
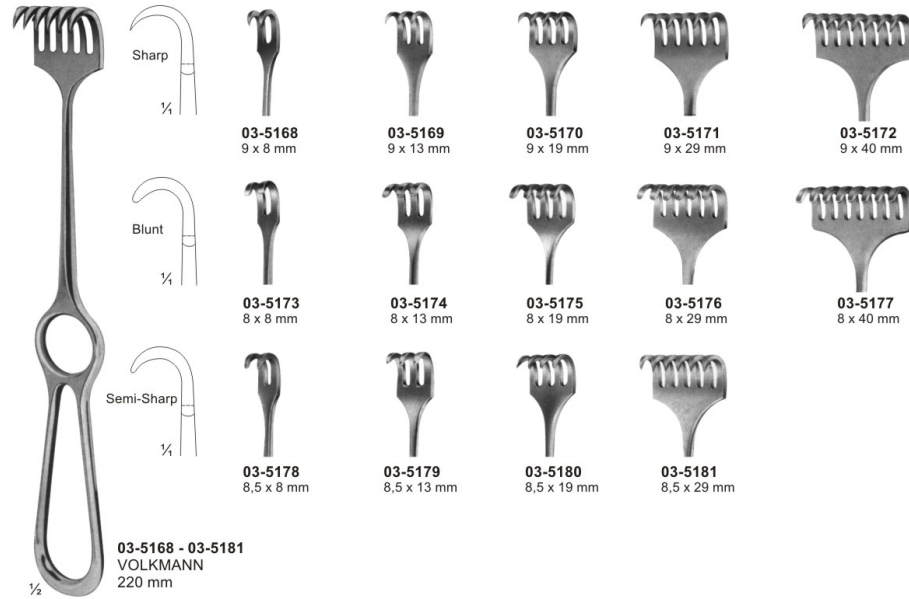

Retractors, Deep form

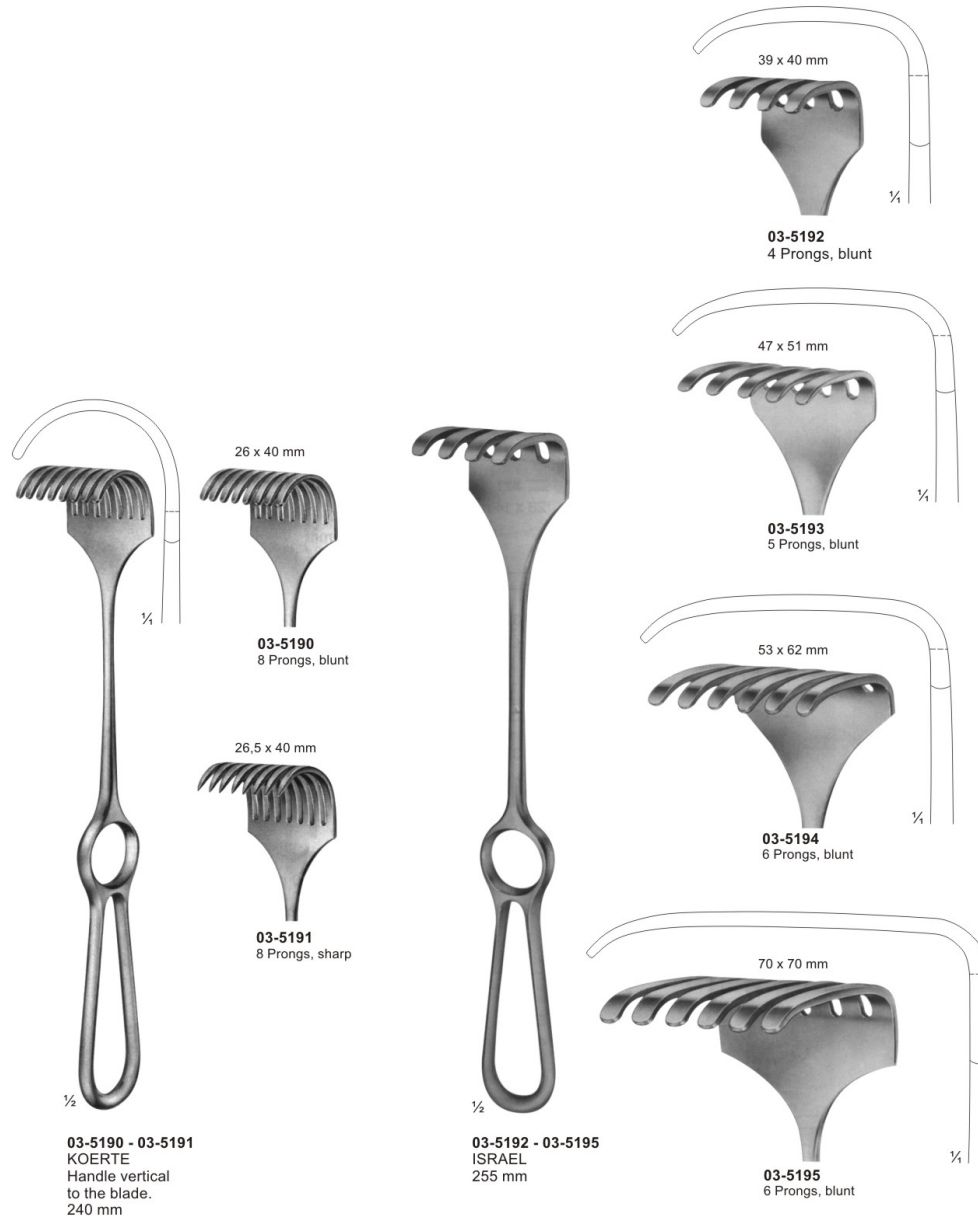

Retractors



03-5196 - 03-5201
LANGENBECK
210 mm

- 03-5196** 28 x 10 mm
- 03-5197** 28 x 14 mm
- 03-5198** 33 x 14 mm
- 03-5199** 28 x 16 mm
- 03-5200** 40 x 10 mm
- 03-5201** 40 x 13 mm



03-5202 - 03-5210
KOCHER-LANGENBECK
215 mm

- 03-5202** 25 x 6 mm
- 03-5203** 35 x 8 mm
- 03-5204** 35 x 11 mm
- 03-5205** 35 x 15 mm
- 03-5206** 41 x 11 mm
- 03-5207** 55 x 11 mm
- 03-5208** 70 x 14 mm
- 03-5209** 80 x 12mm
- 03-5210** 80 x 16mm

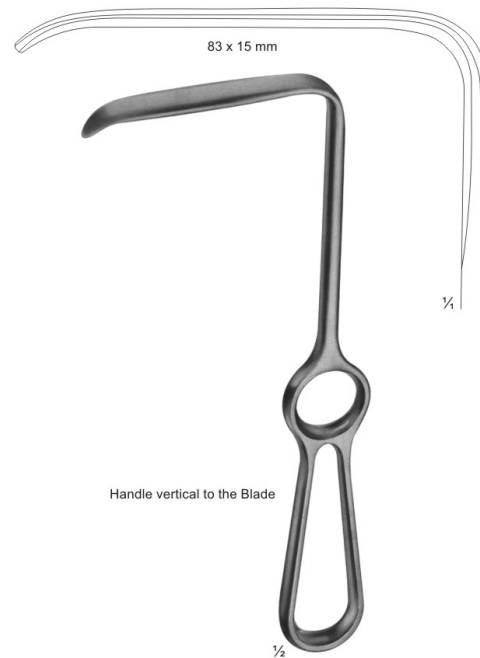

03-5211
LANGENBECK
215 mm

Retractors



03-5212 - 03-5216
KOCHER
230 mm



03-5217 - 03-5219
SAUERBRUCH
225 mm



03-5212
40 x 18 mm



03-5213
60 x 20 mm



03-5214
60 x 25 mm



03-5215
75 x 30 mm



03-5216
75 x 40 mm

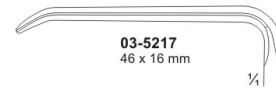

03-5217
46 x 16 mm

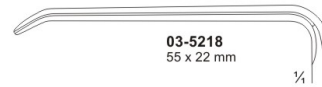

03-5218
55 x 22 mm



03-5219
72 x 19 mm

Retractors

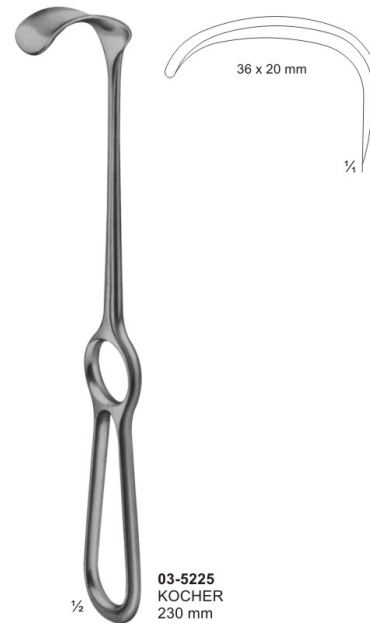
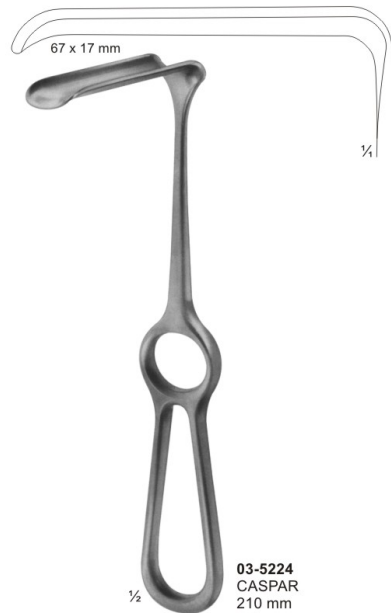
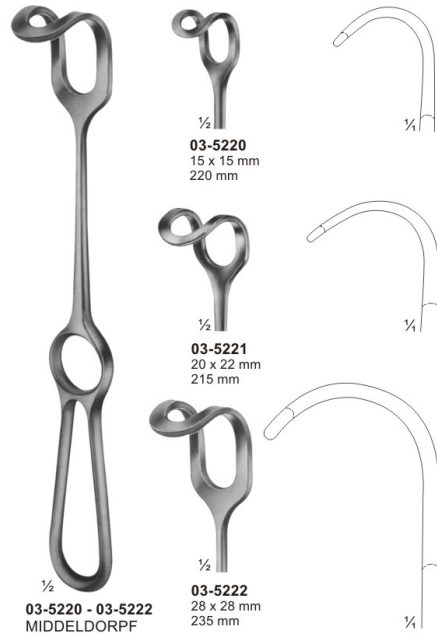

Retractors



03-5226 - 03-5231
HOSEL
250 mm

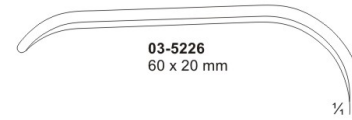

03-5226
60 x 20 mm

¼

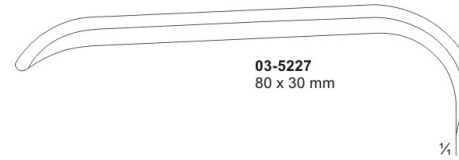

03-5227
80 x 30 mm

¼



03-5228
100 x 30 mm

¼

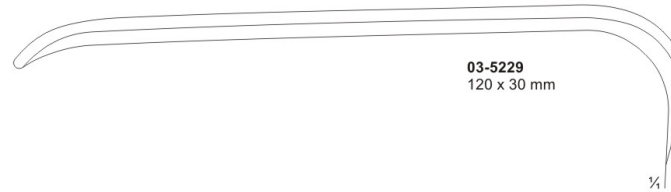

03-5229
120 x 30 mm

¼

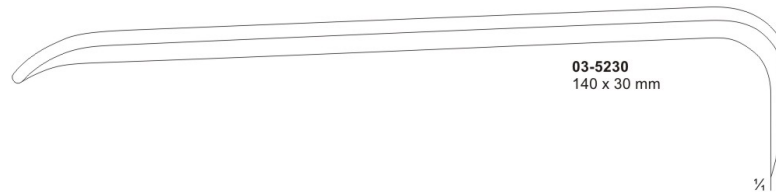

03-5230
140 x 30 mm

¼

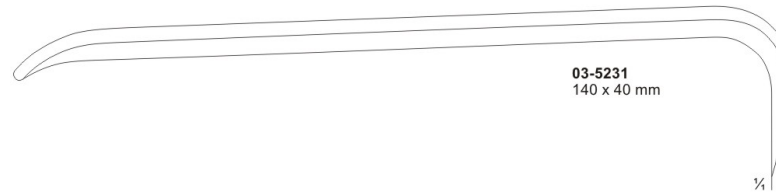

03-5231
140 x 40 mm

¼

Retractors



Retractors

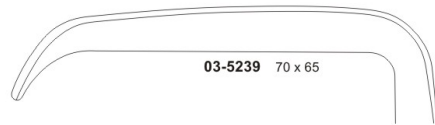

03-5239 - 03-5240
KELLY
260 mm



03-5241 - 03-5242
MORRIS
245 mm

Retractors For Deep Surgery



Retractors For Deep Surgery



**Retractors, Vario Retractor System, Germ. Fed
Patent, Germ. Fed. Regd.Des, US-Patent.**

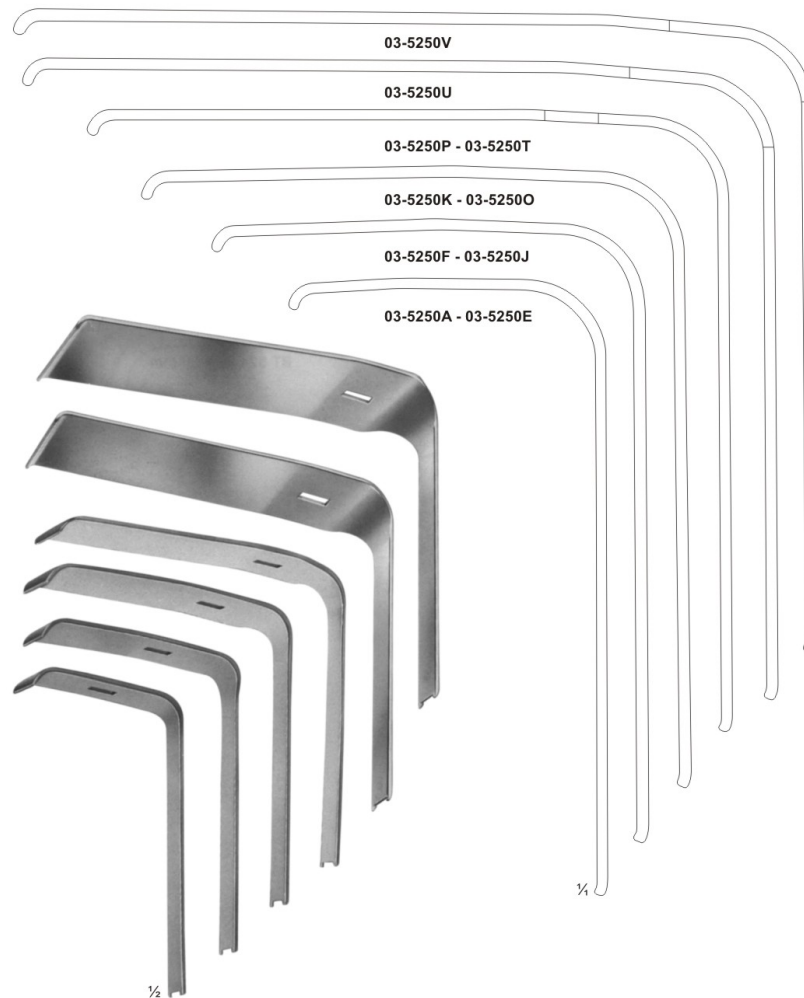

Retractor blades for handles 03-5250

Depth	Width							
	14mm	18mm	22mm	26mm	30mm	40mm	50mm	
55mm	03-5250A	03-5250B	03-5250C	03-5250D	03-5250E	-	-	-
75mm	03-5250F	03-5250G	03-5250H	03-5250I	03-5250J	-	-	-
95mm	03-5250K	03-5250L	03-5250M	03-5250N	03-5250O	-	-	-
115mm	03-5250P	03-5250Q	03-5250R	03-5250S	03-5250T	-	-	-
135mm	-	-	-	-	-	03-5250U	-	-
145mm	-	-	-	-	-	-	03-5250V	-

**Retractors, Vario Retractor System, Germ. Fec
Patent, Germ. Fed. Regd.Des, US-Patent.**



03-5251 - 03-5257
BRUNNER
275 mm

03-5251	80 x 20
03-5252	100 x 25
03-5253	120 x 25
03-5254	130 x 30
03-5255	140 x 30
03-5256	160 x 30
03-5257	180 x 30

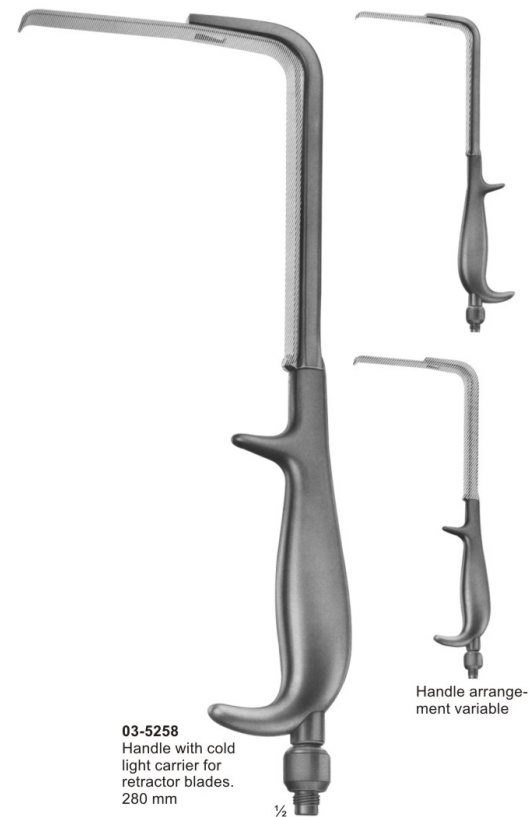

03-5258
Handle with cold
light carrier for
retractor blades.
280 mm

Retractors, Lung Spatulas

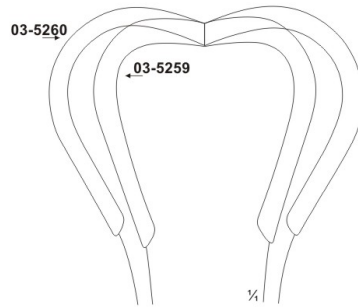

03-5259 - 03-5260
HARRINGTON
03-5259 123 x 45 mm
03-5260 123 x 64 mm
Flexible
295 mm



03-5261
ALLISON
255 mm

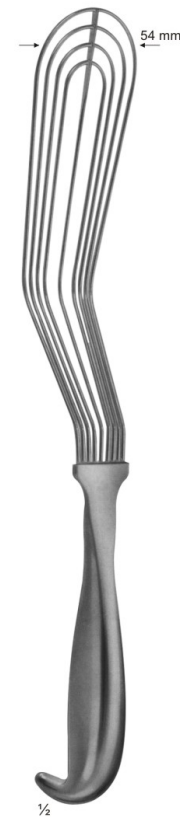

03-5262
ALLISON
320 mm

Retractors, Lung Spatulas

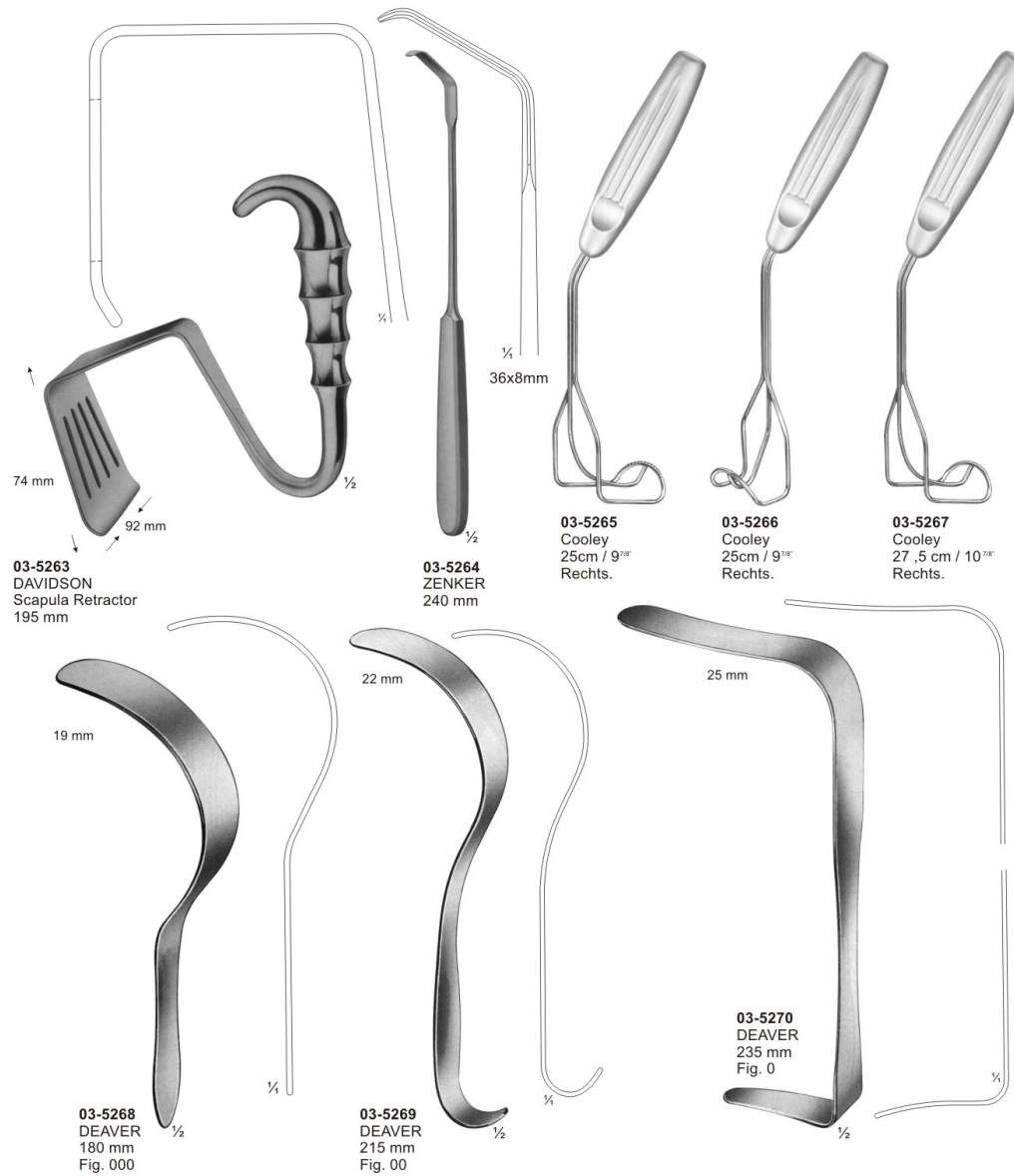

Retractors, Lung Spatulas

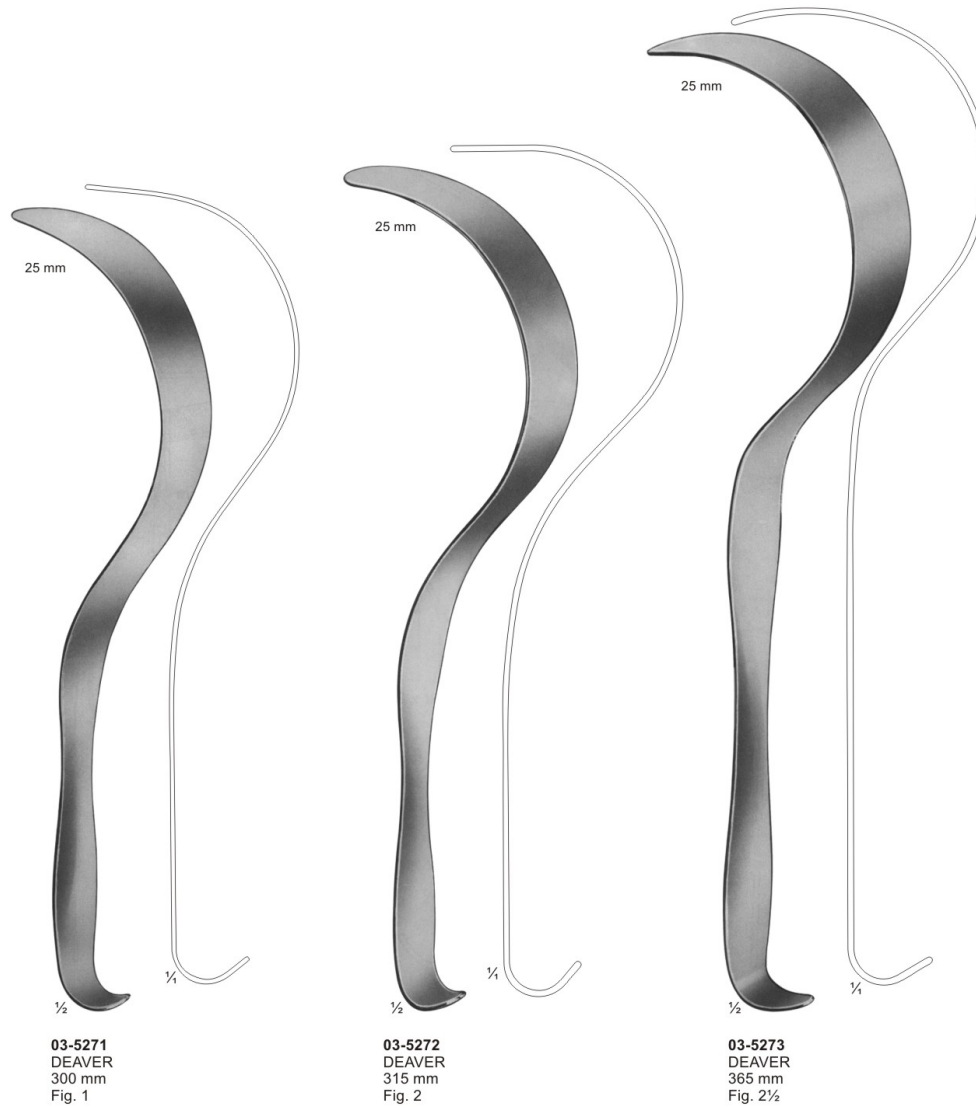

Retractors, Lung Spatulas



03-5274
DEAVER
300 mm
Fig. 3

03-5275
DEAVER
310 mm
Fig. 4

03-5276
DEAVER
320 mm
Fig. 5

Retractors, Lung Spatulas



03-5277
DEAVER
310 mm
Fig. 1

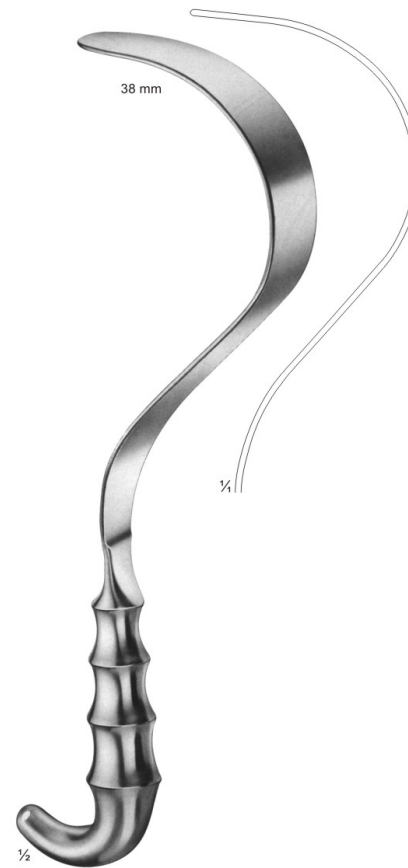

03-5278
DEAVER
310 mm
Fig. 3

Retractors, Lung Spatulas



03-5279
DEAVER
305 mm
Fig. 4



03-5280
DEAVER
310 mm
Fig. 5

**Retractors For Deep Surgery (Abdominal
Retractors)**

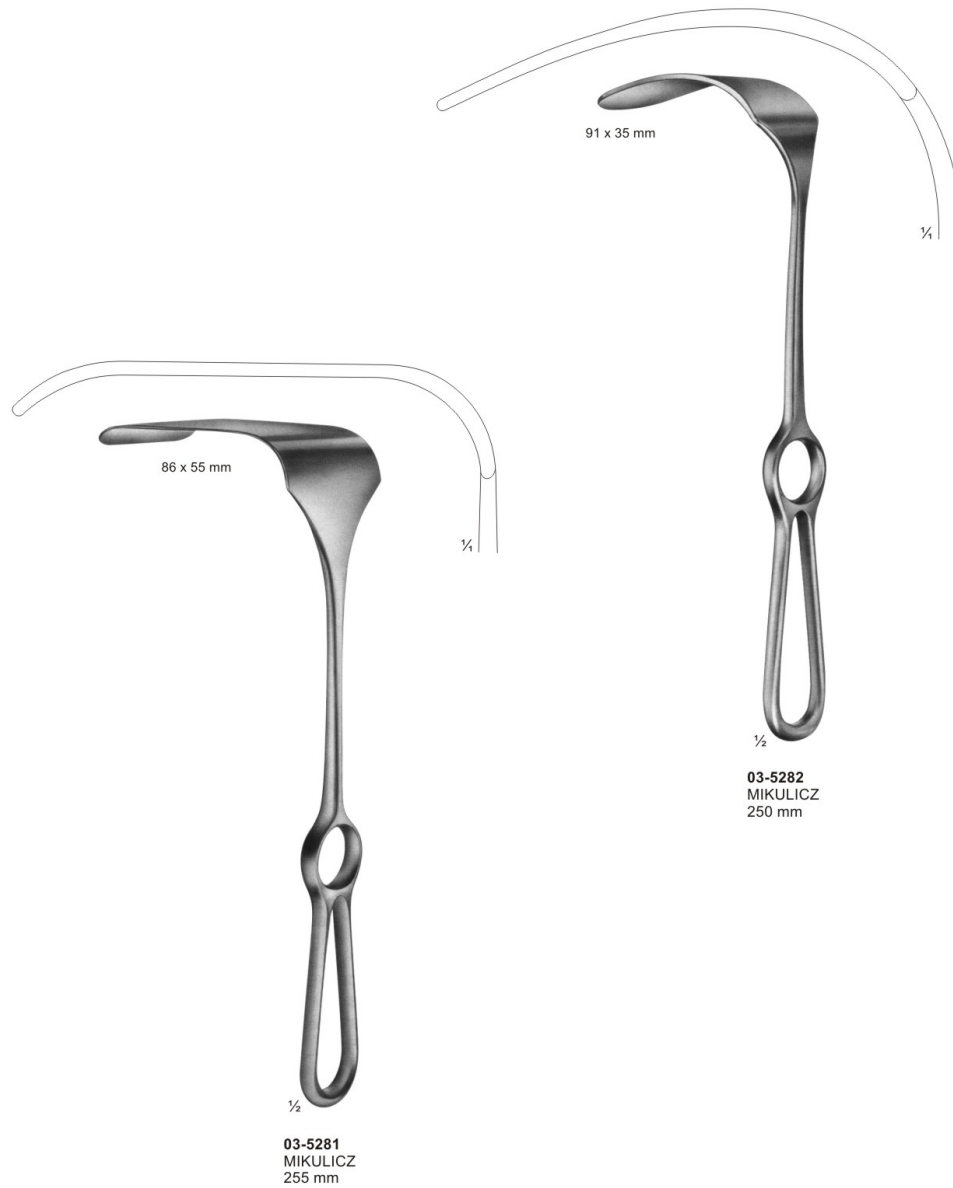

**Retractors For Deep Surgery
(Abdominal Retractors)**

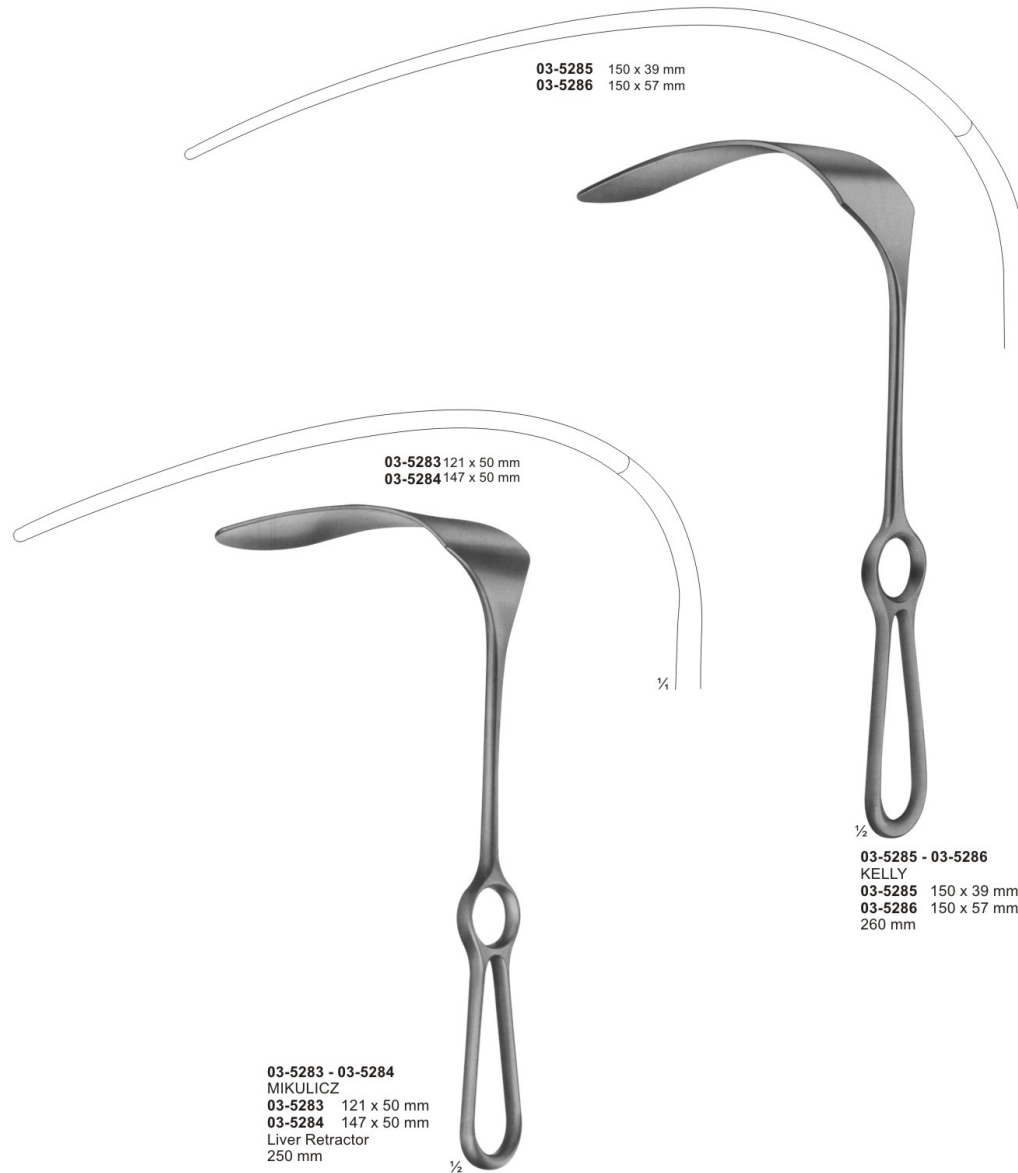

Retractors, Abdominal Retractors

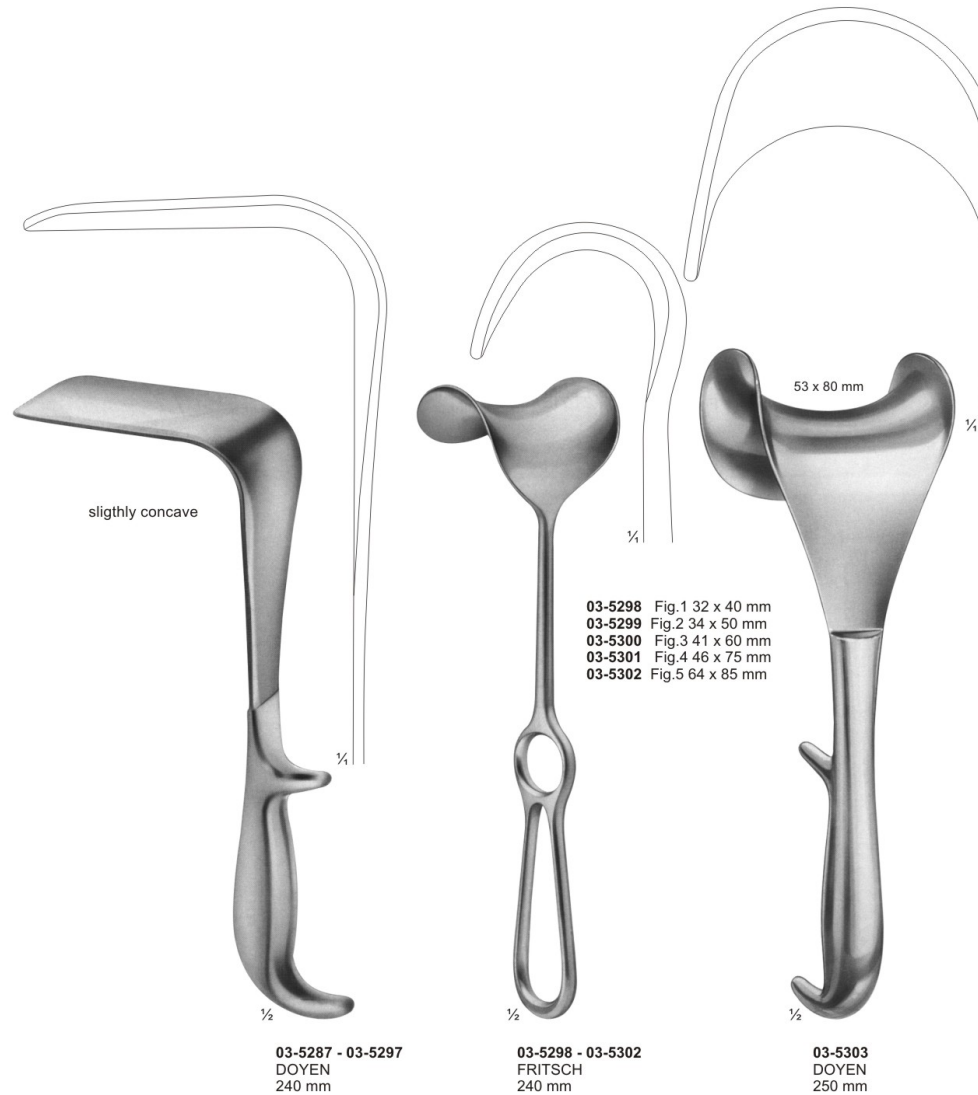

Length of Blades	Width of Blades		
	35mm	45mm	60mm
62mm	03-5287	03-5290	03-5294
92mm	03-5288	03-5291	03-5295
122mm	03-5289	03-5292	03-5296
160mm		03-5293	03-5297

Abdominal Retractors



03-5304 - 03-5308
ROCHARD
310 mm
03-5304 48 x 90 mm
03-5305 48 x 105 mm
03-5306 48 x 120 mm
03-5307 48 x 135 mm
03-5308 48 x 155 mm

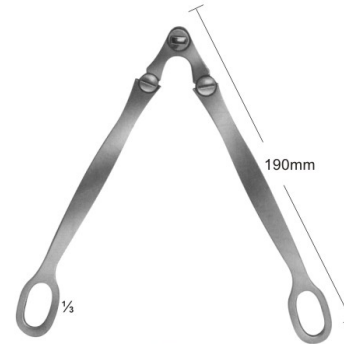

03-5309
ROCHARD
Fixation device for



03-5310 - 03-5313
DOYEN
280 mm
03-5310 48 x 90 mm
03-5311 48 x 105 mm
03-5312 48 x 120 mm
03-5313 48 x 135 mm



03-5314
DOYEN-CHILD
Fixation device
220 mm



03-5315
Chain
with weight
645g
790 mm

Pelvis Retractors

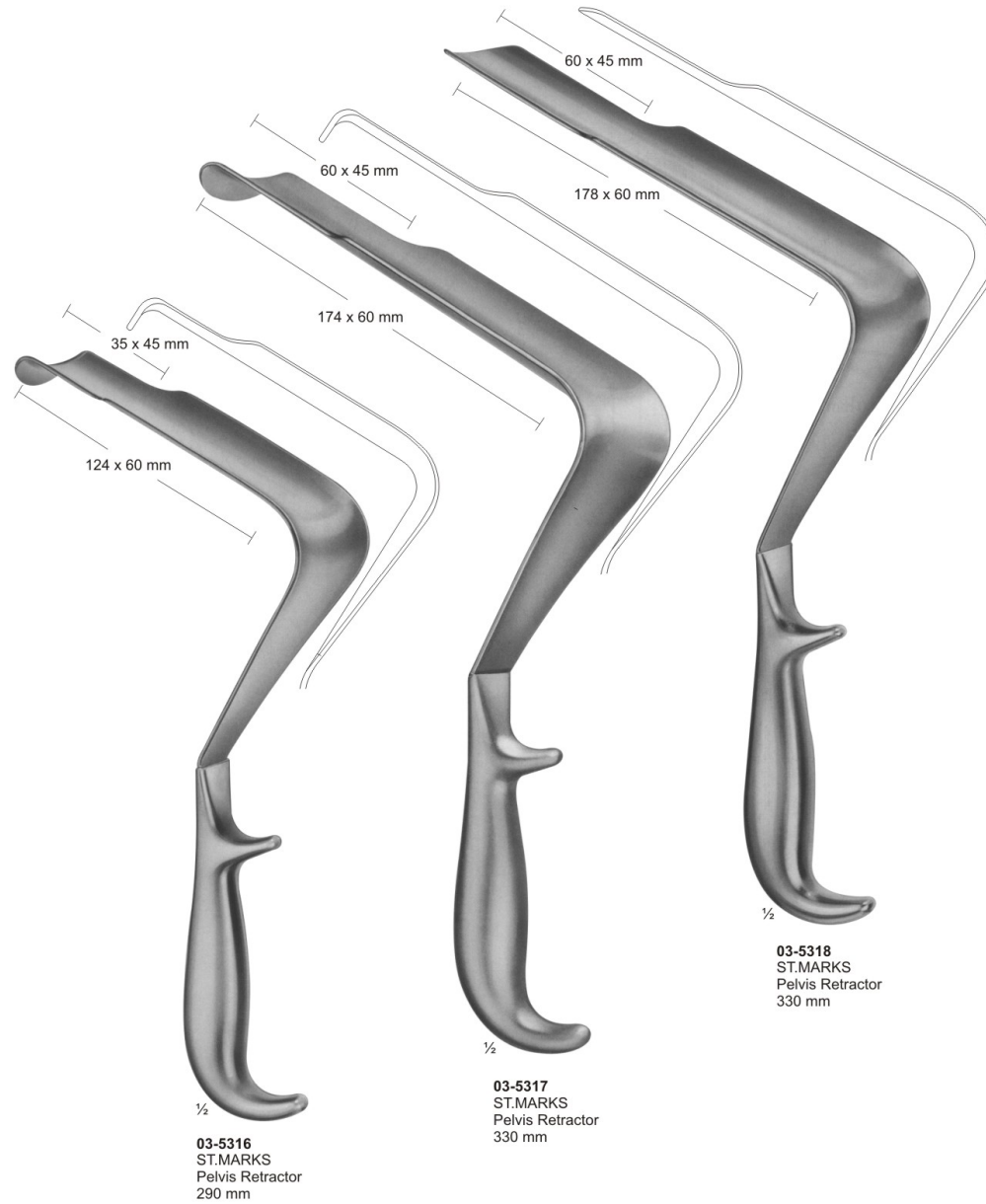

Abdominal- and Intestinal Spatulas

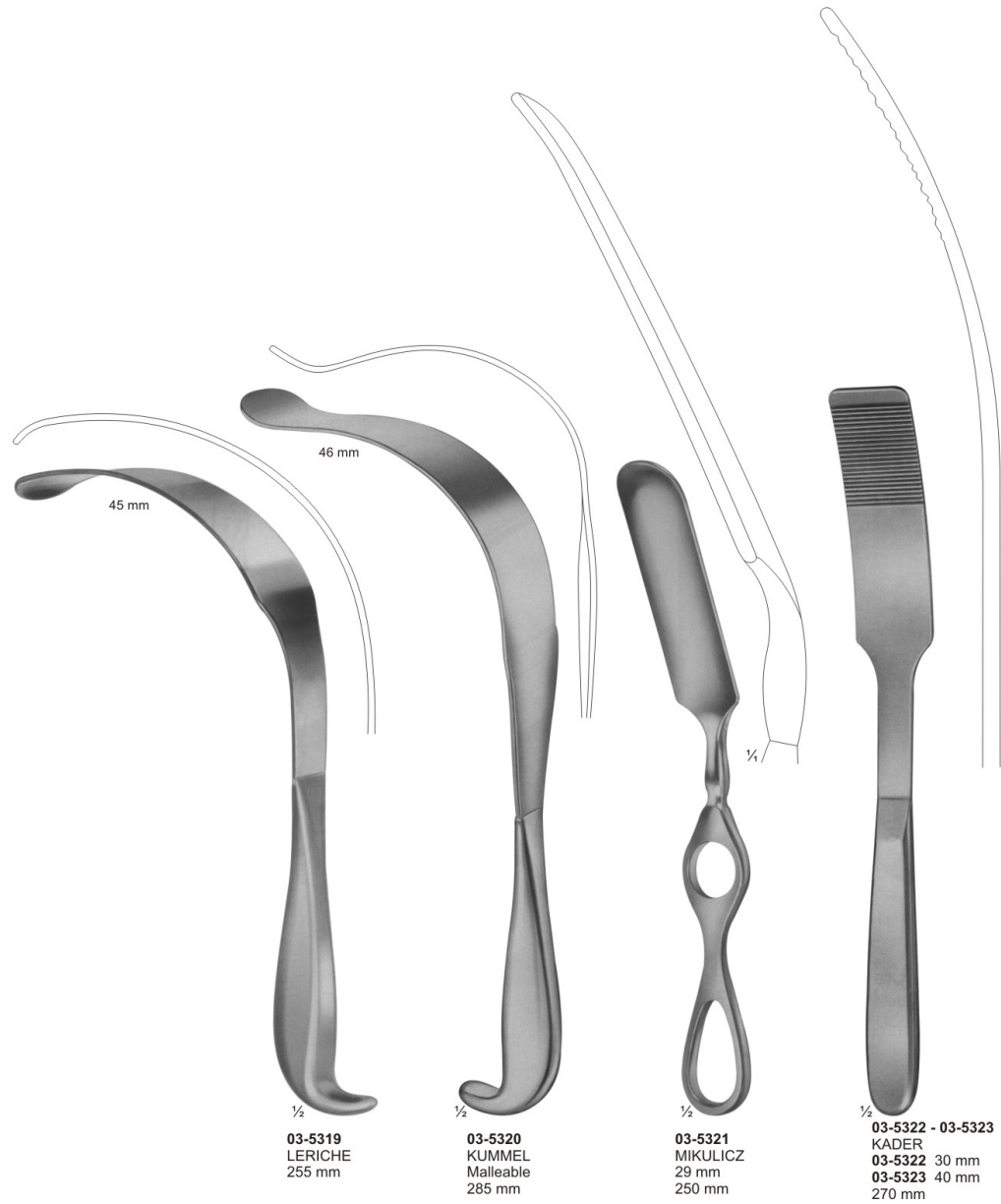

Abdominal- and Intestinal Spatulas



03-5324
REVERDIN
285 mm



03-5325
HABERER
Malleable
305 mm



03-5326 - 03-5328
03-5326 30 mm
03-5327 40 mm
03-5328 50 mm
Malleable
330 mm



03-5329
TUFFIER
Malleable
200 mm

Self-Retaining Retractors



03-5330
BOSE
60 mm



03-5331
FINSEN
50 mm



03-5332
FINSEN
70 mm



03-5333
FINSEN modif.
75 mm



03-5334
45 mm



03-5335
55 mm



03-5336
MUELLER
65 mm



03-5337
100 mm



03-5338



03-5338 - 03-5339
03-5338 70 mm
03-5339 100 mm



03-5340
LOGAN
modif. REILL
50 mm



03-5341
JANSEN
100 mm



03-5342
JANSEN
100 mm

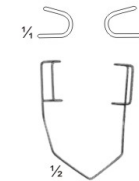

03-5343
BARRAQUER
45 mm

Self-Retaining Retractors



03-5344
WEITLANER
Sharp
110 mm



03-5345
WEITLANER
Semi-Sharp
110 mm



03-5346
WEITLANER
Blunt
110 mm



03-5347
WEITLANER
Sharp
130 mm



03-5348
WEITLANER
Semi-Sharp
130 mm



03-5349
WEITLANER
Blunt
130 mm

Self-Retaining Retractors

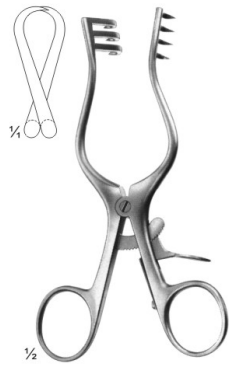

03-5350
WEITLANER
Sharp
130 mm

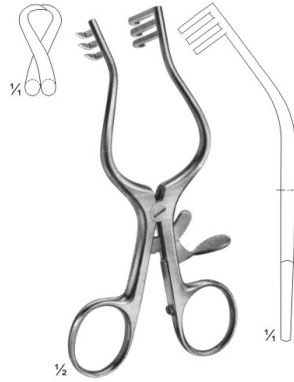

03-5351
WULLSTEIN
Sharp
130 mm

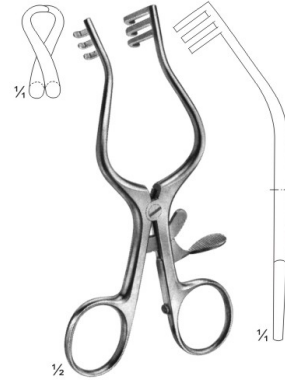

03-5352
WULLSTEIN
Blunt
130 mm

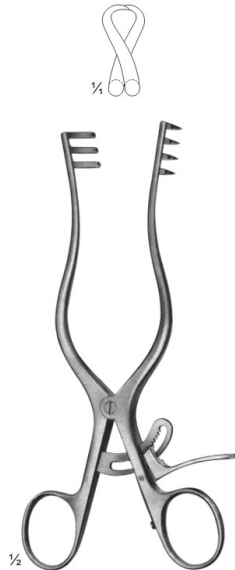

03-5353
WEITLANER
Sharp
165 mm



03-5354
PLESTER
Blunt
110 mm



03-5355
PERKINS
130 mm

Self-Retaining Retractors



03-5356
ADSON-BABY
Blunt
140 mm

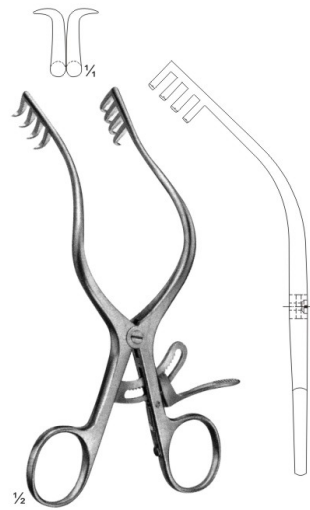

03-5357
MOLLISON
Sharp
155 mm



03-5358
MAYO-ADAMS
165 mm

Self-Retaining Laminectomy Retractors

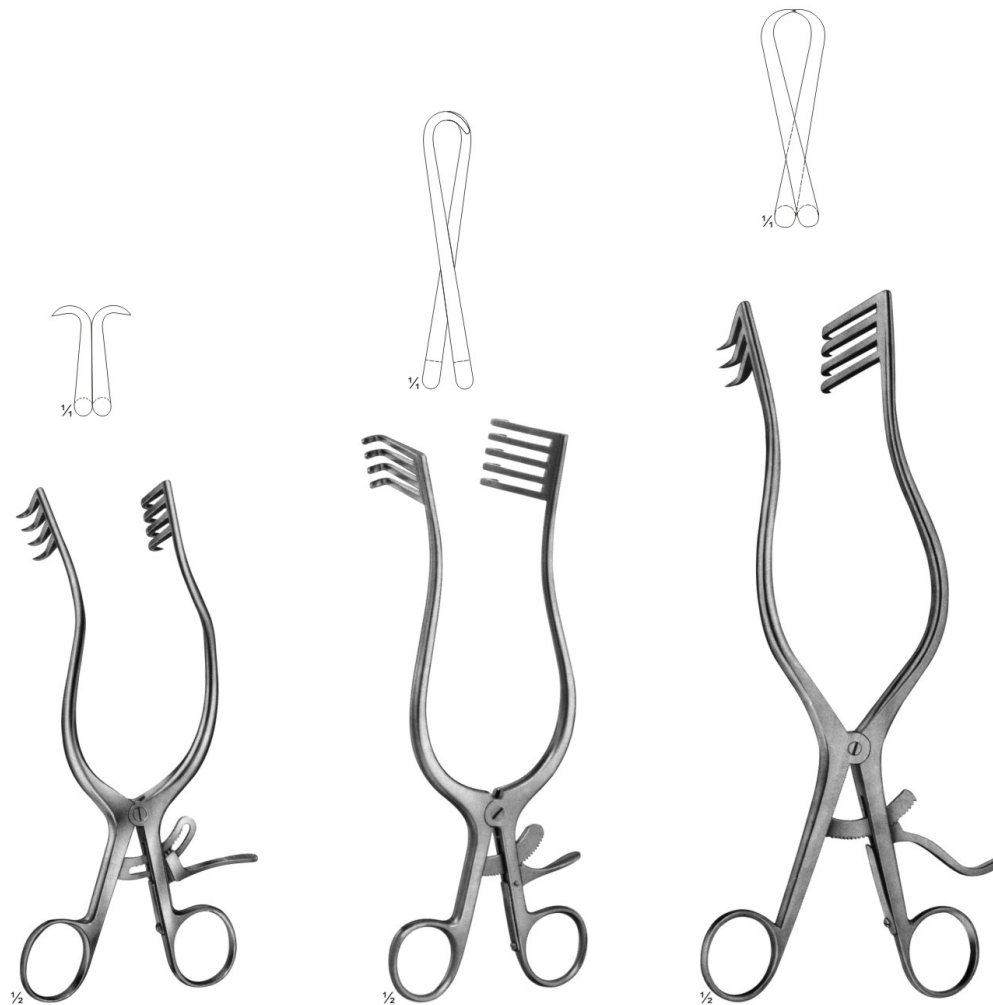

03-5359
ANDERSON-ADSON
Sharp
190 mm

03-5360
NORFOLK and
NORWICH
Blunt
220 mm

03-5361
ADSON
Sharp
265 mm

Self-Retaining Laminectomy Retractors

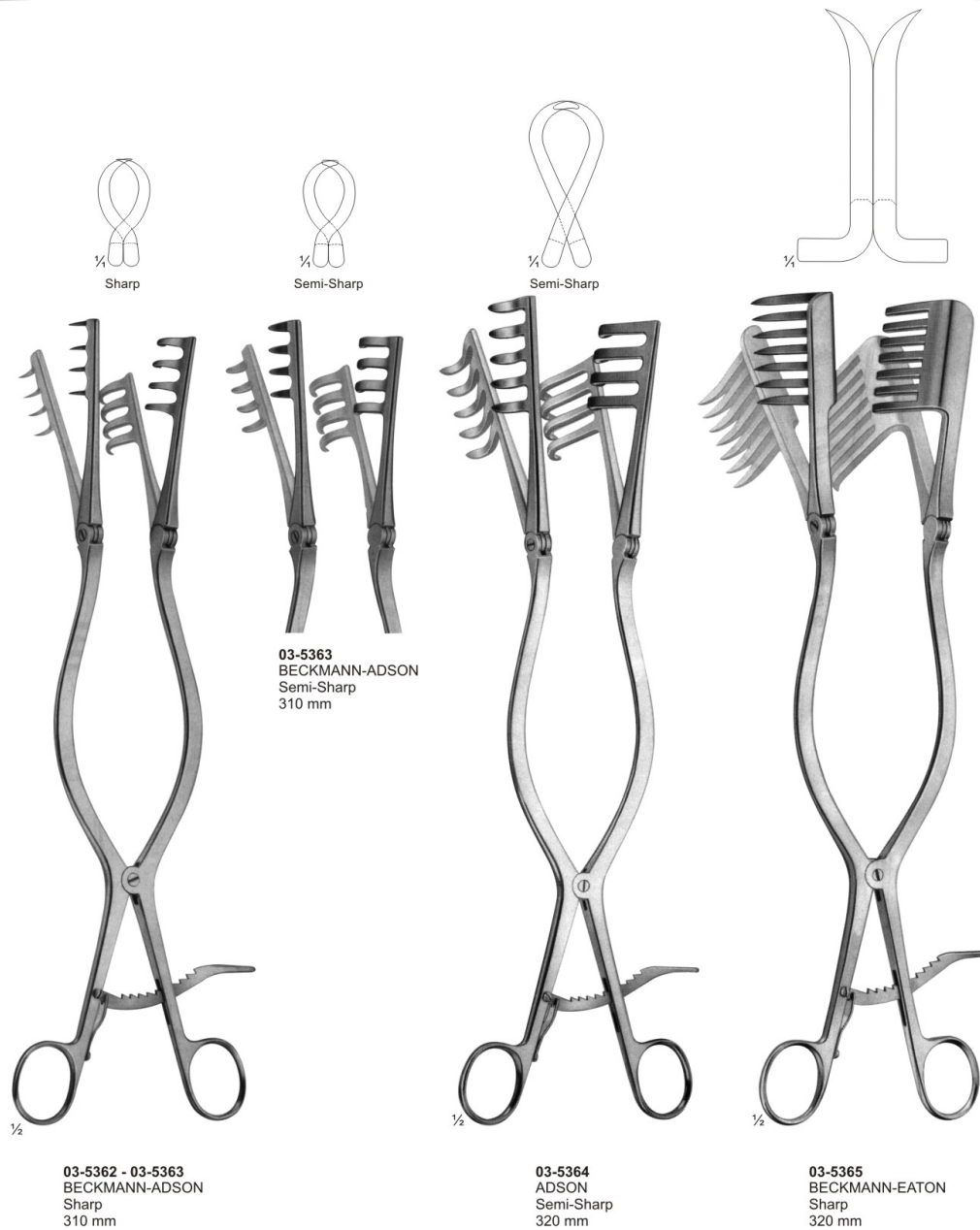

03-5362 - 03-5363
BECKMANN-ADSON
Sharp
310 mm

03-5363
BECKMANN-ADSON
Semi-Sharp
310 mm

03-5364
ADSON
Semi-Sharp
320 mm

03-5365
BECKMANN-EATON
Sharp
320 mm

Special Retractors



1/2

03-5366
JOLL (FRIEDMAN)
Thyroid- and Vaginal Retractor
155 mm

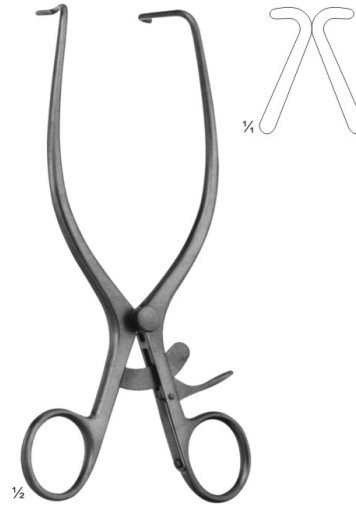

1/2

03-5367
JACKSON BURROWS
Retractor, blunt
185 mm



1/2

03-5368
GELPI
Vaginal Retractor
135 mm



1/2

03-5369
GELPI
Skin- and Vaginal Retractor
175 mm



1/2

03-5370
DE BAKEY
Femur Retractor
145 mm

Self Retaining Retractors for Laminectomy and other Operations

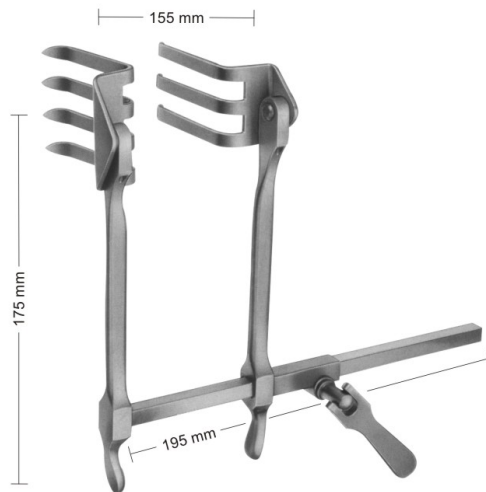

03-5371
SCOVILLE-RICHTER
Retractor with 1 pair
blades reversible type.
The Retractor bar and shanks
may be easily rotated 180° when
blades are in situ.



03-5372
62 x 52 mm
PR= Pair

62 x 37 mm



03-5373
47 x 51 mm



03-5374
30 x 40 mm



03-5375
37 x 62 mm

Retractors for Cervical Spine

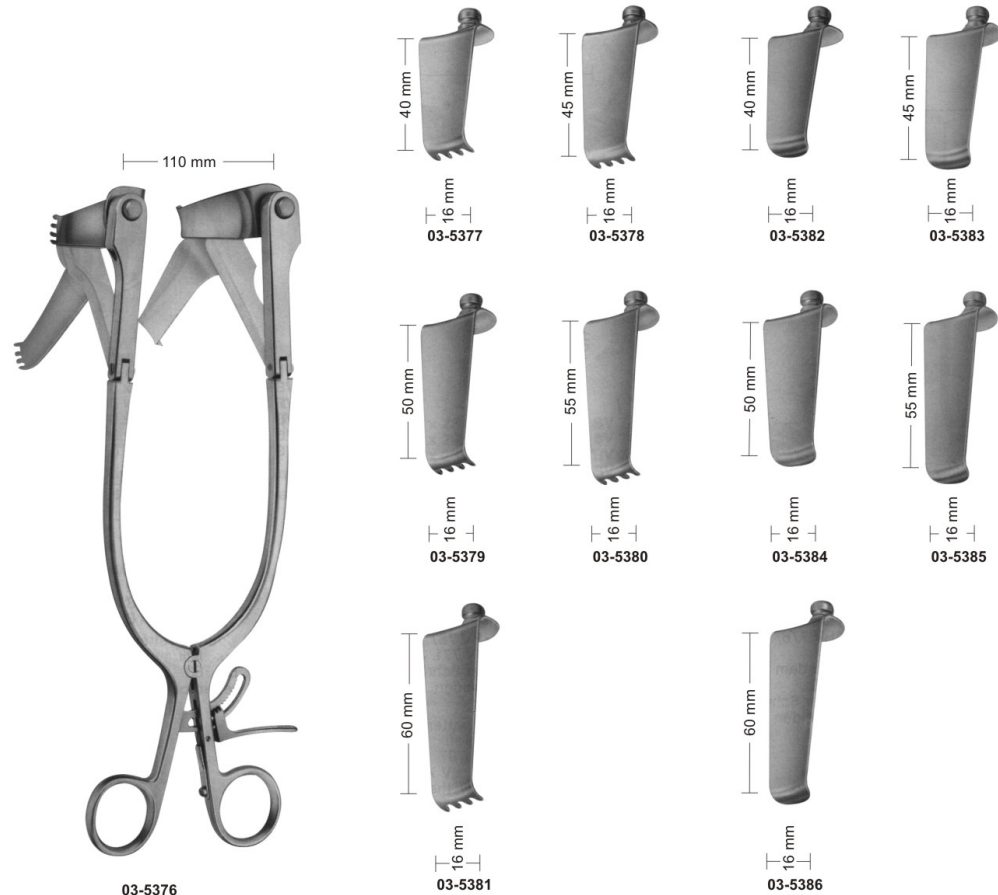

03-5376
CLOWARD modif.
Spreader Only
Consisting of:
Spreader Only
03-5377 1 Blade
03-5378 1 Blade
03-5379 1 Blade
03-5380 1 Blade
03-5381 1 Blade

Blades only used for **03-5376**

Retractors for Cervical Vertebral Column

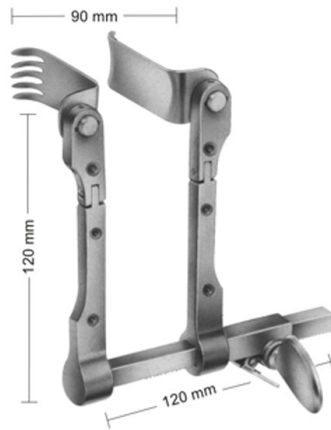

03-5387
CASPAR
Retractor, adjustable, consisting of:
5 medial blades (**03-5389 - 03-5393**) 5 Lateral
blades. (**03-5394 - 03-5398**) and the retractor
only By Reversing the Screw,
The Retractor Can be Used From Both Sides

To be used preferably for transverse retraction.



03-5388
CASPAR
Counter retractor, adjustable,
consisting of: 5 blades. (**03-5399 - 03-5403**)
and the retractor only

To be used preferably for
up and down retraction.



03-5389 40 x 23 mm
03-5390 45 x 23 mm
03-5391 50 x 23 mm
03-5392 55 x 23 mm
03-5393 60 x 23 mm
Medial blades

03-5394 40 x 23 mm
03-5395 45 x 23 mm
03-5396 50 x 23 mm
03-5397 55 x 23 mm
03-5398 60 x 23 mm
Lateral blades

03-5399 45 x 23 mm
03-5400 50 x 23 mm
03-5401 55 x 23 mm
03-5402 60 x 23 mm
03-5403 65 x 23 mm
Blunt blades

03-5404 50 x 25 mm
03-5405 60 x 25 mm
Blunt blades,
for harvesting of the
fusion graft from the
iliac crest

03-5406 40 x 25 mm
03-5407 45 x 25 mm
03-5408 50 x 25 mm
03-5409 55 x 25 mm
03-5410 60 x 25 mm
Medial Titan blades
semi transparent to x-ray

03-5411 40 x 25 mm
03-5412 45 x 25 mm
03-5413 50 x 25 mm
03-5414 55 x 25 mm
03-5415 60 x 25 mm
Lateral Titan blades
semi transparent to x-ray

Lamina Spreaders



03-5416
CLOWARD
155 mm



03-5417
CLOWARD
135 mm

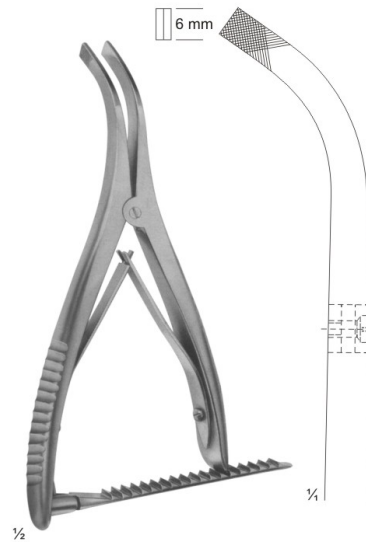

03-5418
INGE
170 mm

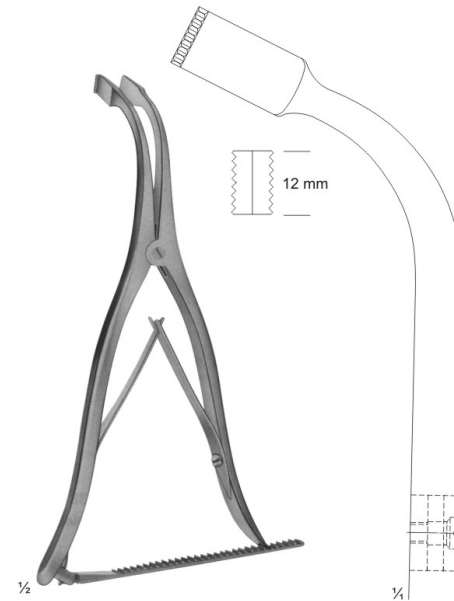

03-5419
INGE
275 mm

Abdominal Retractors

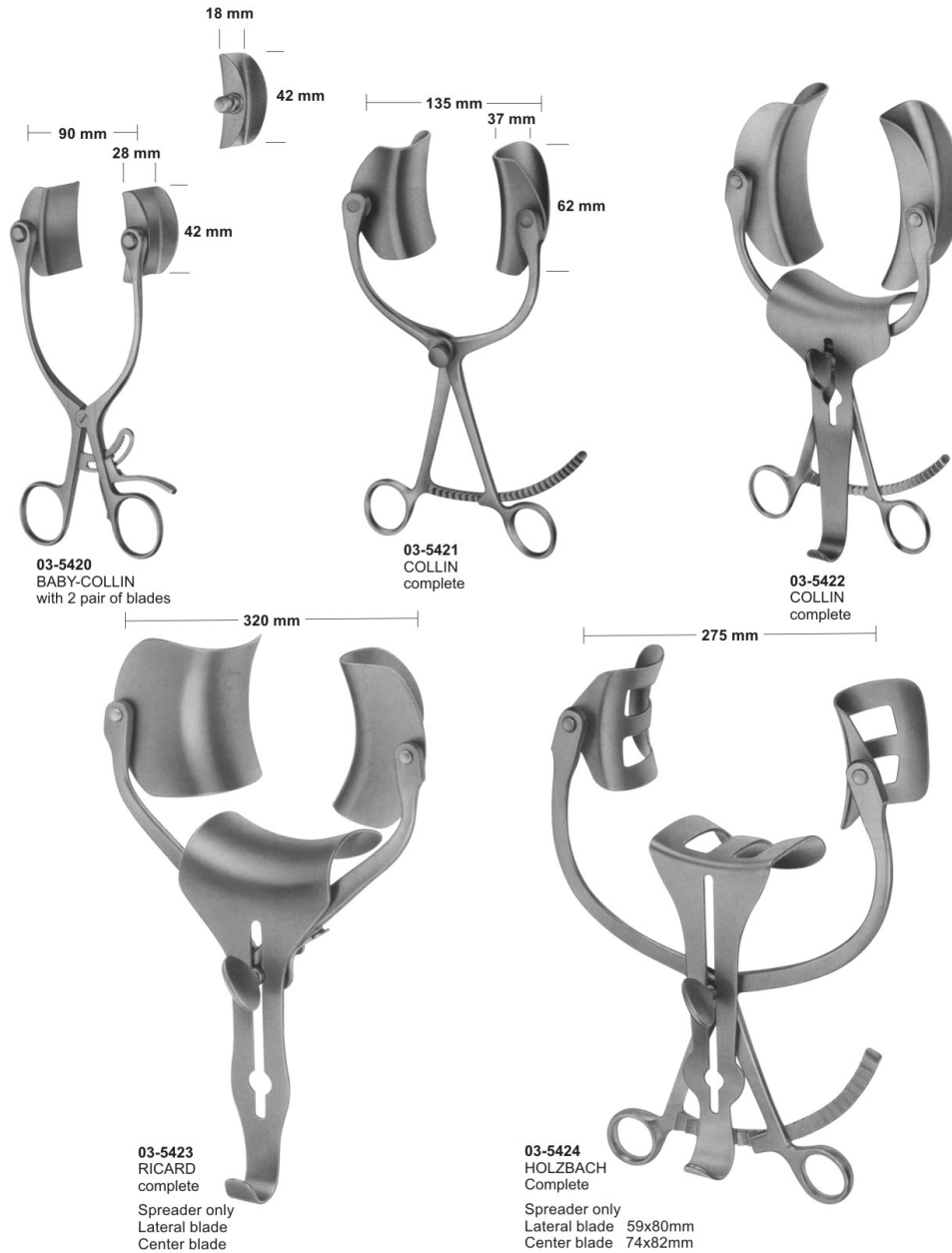

Abdominal Baldes

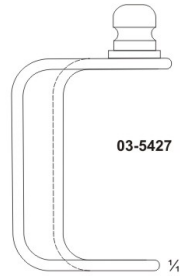

03-5427

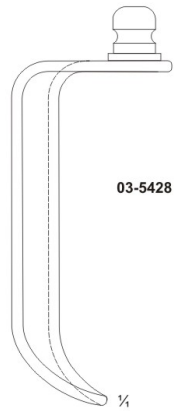

03-5428

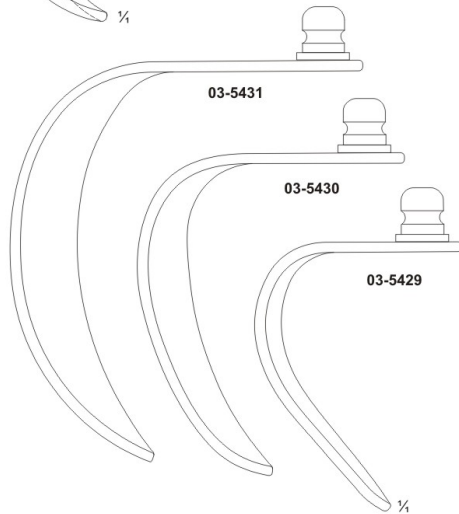

03-5431

03-5430

03-5429

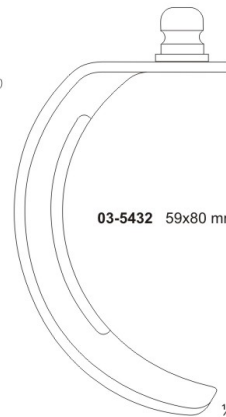

03-5432 59x80 mm

Lateral blades only
03-5425 37x62 mm
03-5426 37x80 mm
03-5427 37x98 mm



03-5428 61x80 mm



03-5429 48x59 mm
03-5430 58x80 mm
03-5431 72x84 mm

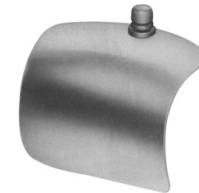

Abdominal Retractors

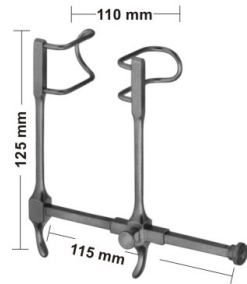

03-5433
GOSSET
Blades: 38 mm deep

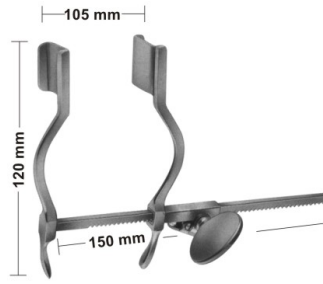

03-5434
HERTZLER
Blades: 20 X 25 mm

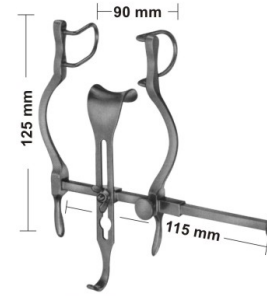

03-5435
BALFOUR-BABY
Lateral blades 27 mm deep
(03-5435) Center blade 21x24 mm

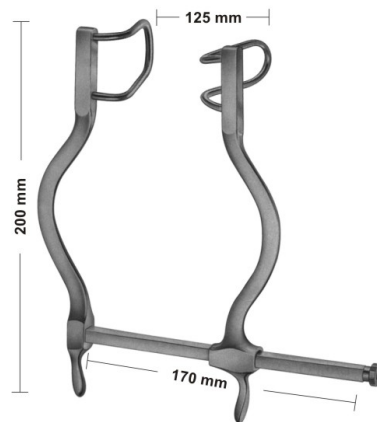

03-5436
GOSSET
Blades: 55 mm deep

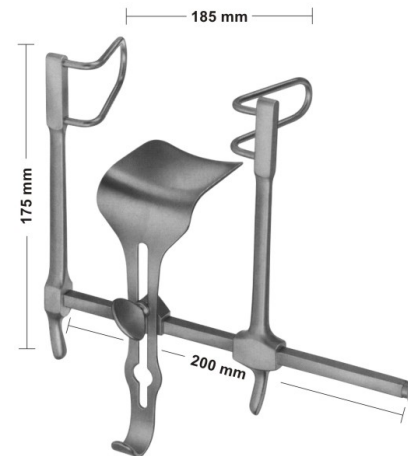

03-5437
GOSSET
Lateral blades 58 mm deep
Center blade
59 x 57 mm

Abdominal Retractors

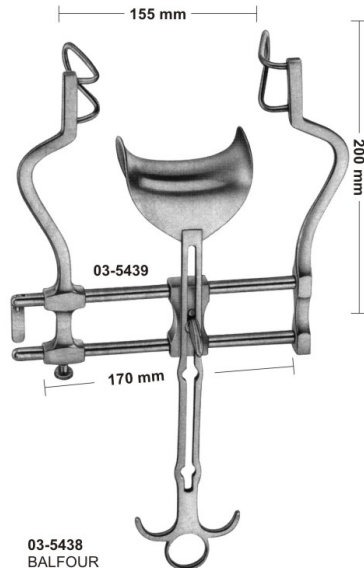

03-5438
BALFOUR
Lateral blades 60 mm deep
(03-5439) Center blade
47 x 80 mm

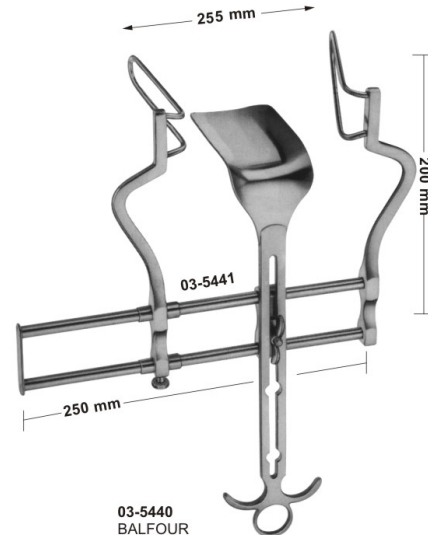

03-5440
BALFOUR
Lateral blades 105 mm deep
(03-5441) Center blade
107 x 59 mm



03-5442
Center blade only
54x80 mm

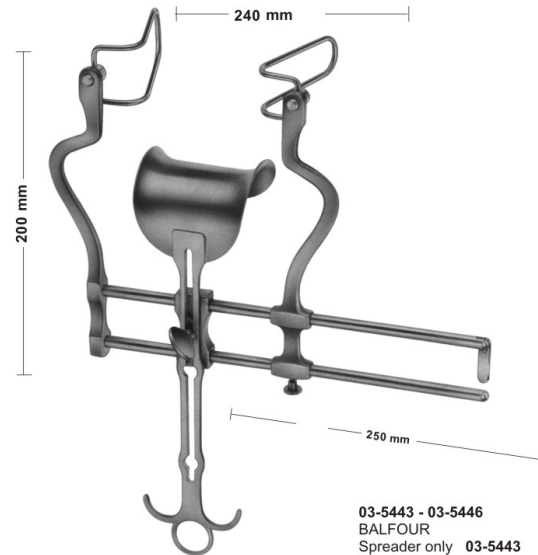

03-5443 - 03-5446
BALFOUR
Spreader only
Lateral blades
Center blade

03-5443	03-5444	03-5445	03-5446
50 mm	60 mm	75 mm	90 mm
47 x 80 mm	62x76 mm	80x80 mm	80x80 mm



Lateral blades
03-5447
50 mm deep
03-5448
60 mm deep
03-5449
75 mm deep
03-5450
80 mm deep
03-5451
90 mm deep
Sales Unit of blades:PR = pair

Abdominal Retractors

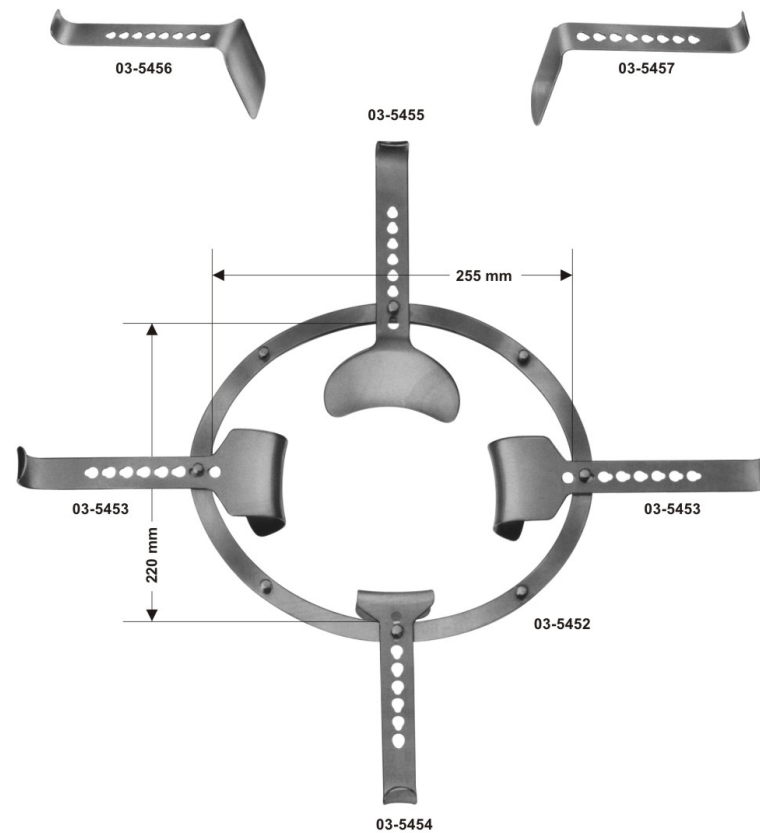

- 03-5451**
SEM
consisting of:
- 03-5452** 1 frame 225 x 220 mm
 - 03-5453** 2 blades 46 x 64 mm
 - 03-5454** 1 blade 53 x 54 mm
(for bladder)
 - 03-5455** 1 blade 82 x 97 mm
(for intestine)
 - 03-5456** 1 blade 98 x 51 mm
(for intestine)
 - 03-5457** 1 blade, narrow
107 x 36 mm

Abdominal Retractors

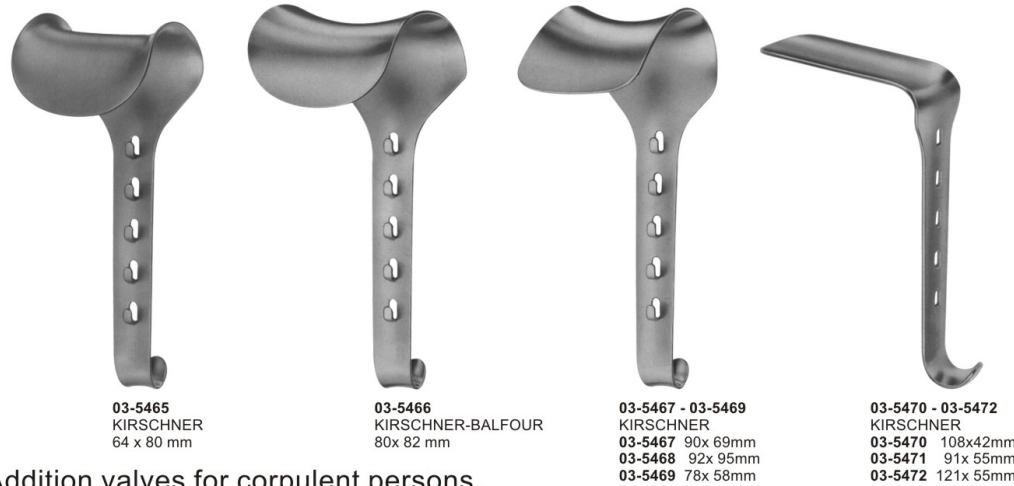
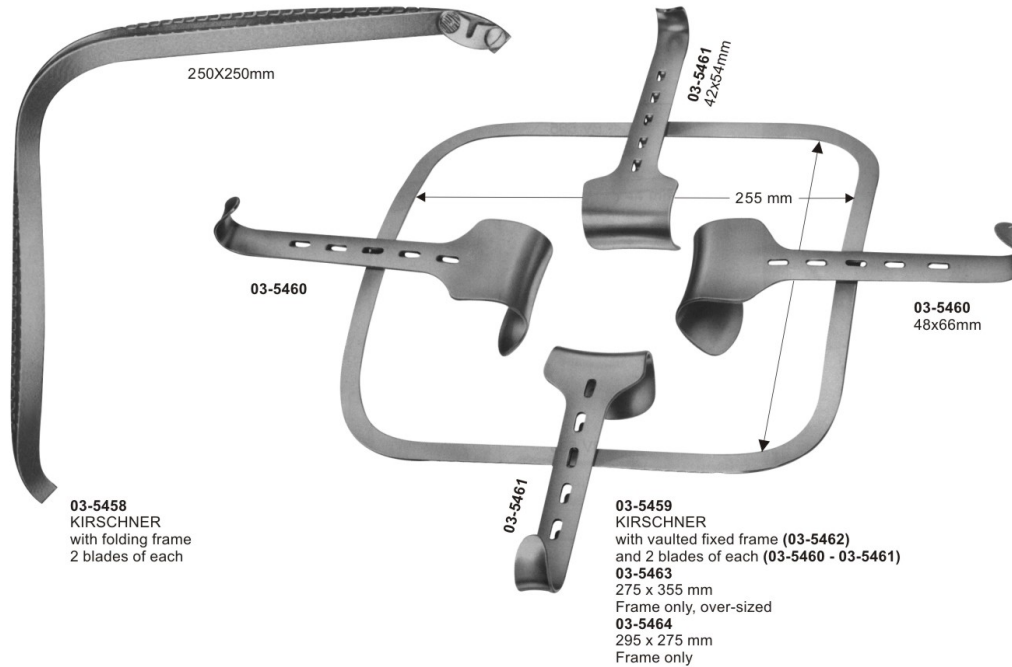

Addition valves for corpulent persons.

Intestinal and Tissue Grasping Forceps

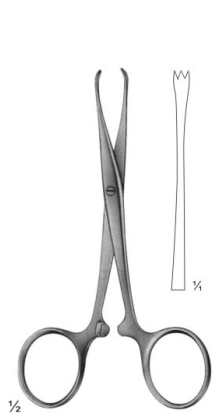

03-5473
CHAPUT
2 X 3 teeth, sharp
125 mm,

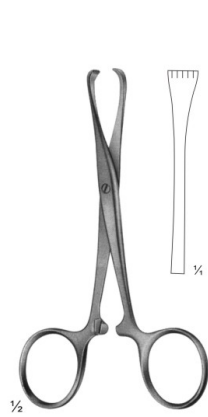

03-5474
TUFFIER
5 X 6 teeth, sharp
125 mm,



03-5475
BOYS-ALLIS
5 X 6 teeth, sharp
155 mm,



03-5476
BABY-ALLIS
4 X 5 teeth
130mm

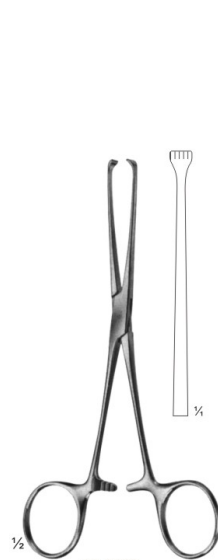

03-5477
ALLIS
4 X 5 teeth
155 mm,

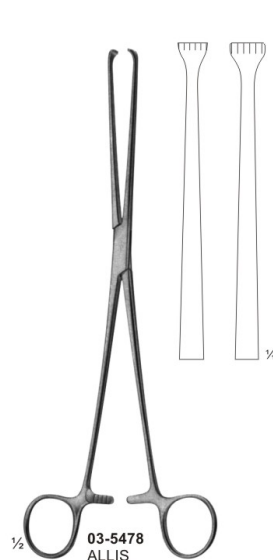

03-5478
ALLIS
190 mm,
03-5479
255 mm,
5 X 6 teeth
Slender pattern

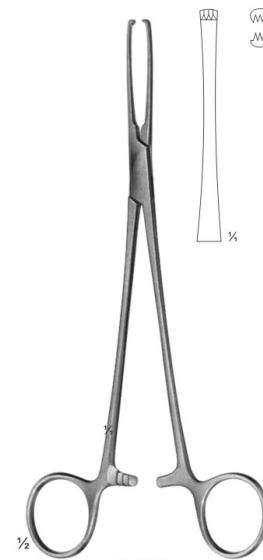

03-5480
JUDD-ALLIS
3 X 4 teeth
195 mm,

Intestinal Grasping Forceps

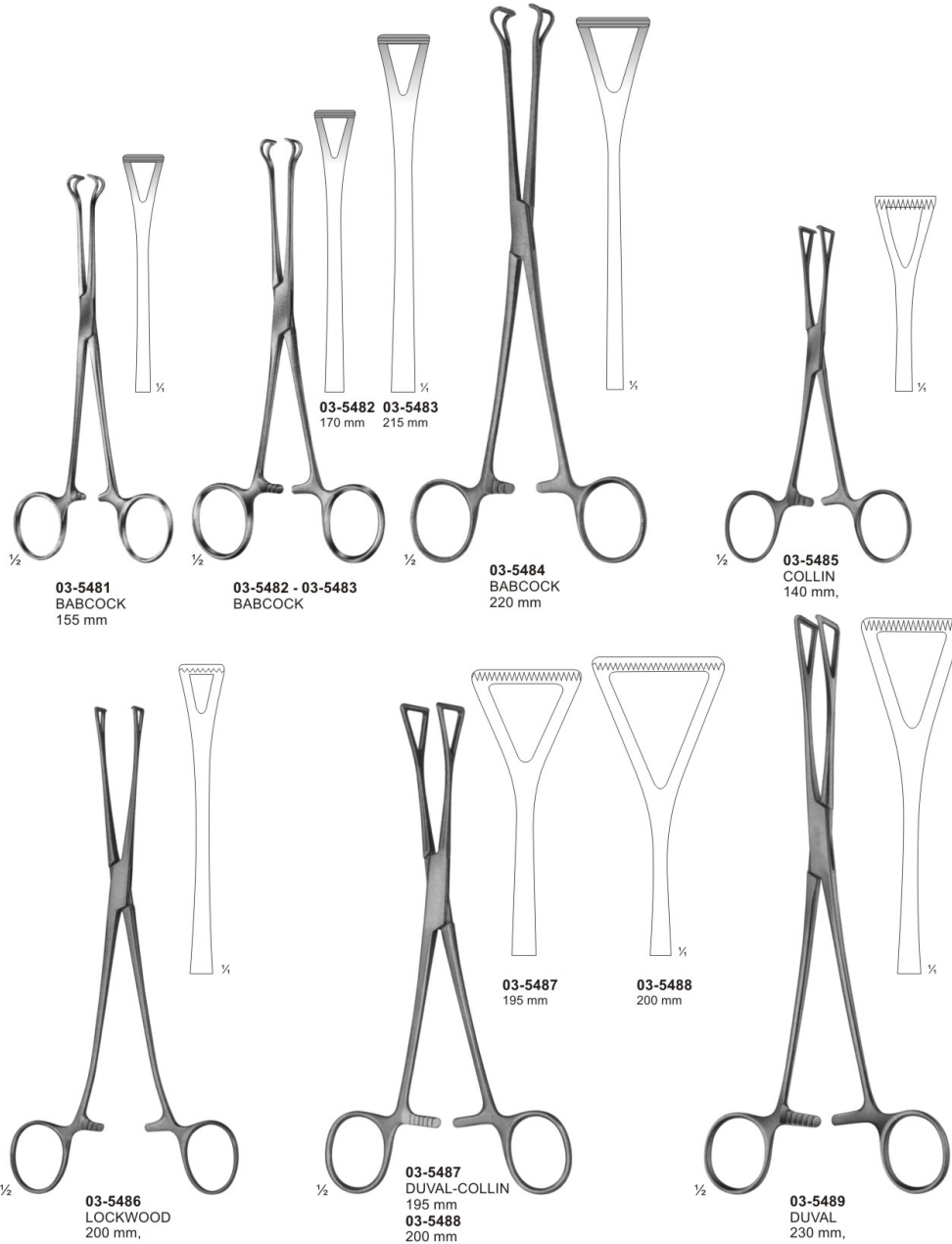

**Organ - Tissue Grasping, Intestinal and
Dissecting Forceps**

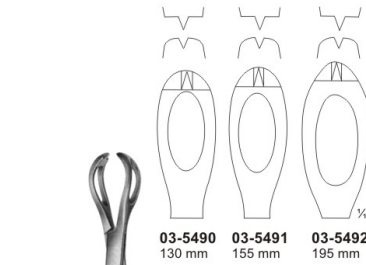

03-5490 - 03-5492
LANE

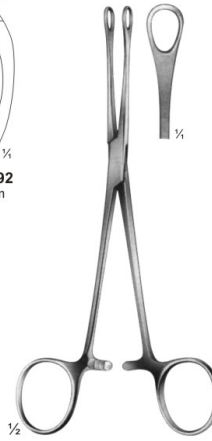

03-5493
WILLIAMS
160 mm



03-5494
DENIS
BROWNE
190 mm



03-5495
DUVAL
140 mm



03-5496 - 03-5497
WANGENSTEEN
03-5496 150 mm
03-5497 230 mm

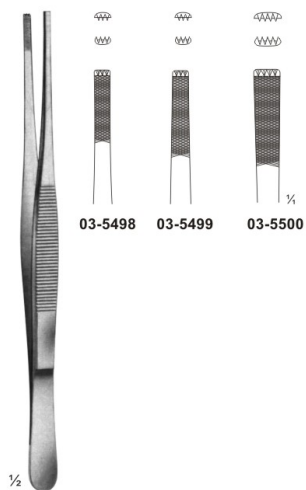

03-5498 - 03-5500
STILLÉ-BARRAYA
03-5498 180mm
03-5499 200mm
03-5500 250mm

**Organ - Tissue Grasping & Intestinal Forceps
ATRAUMATA**

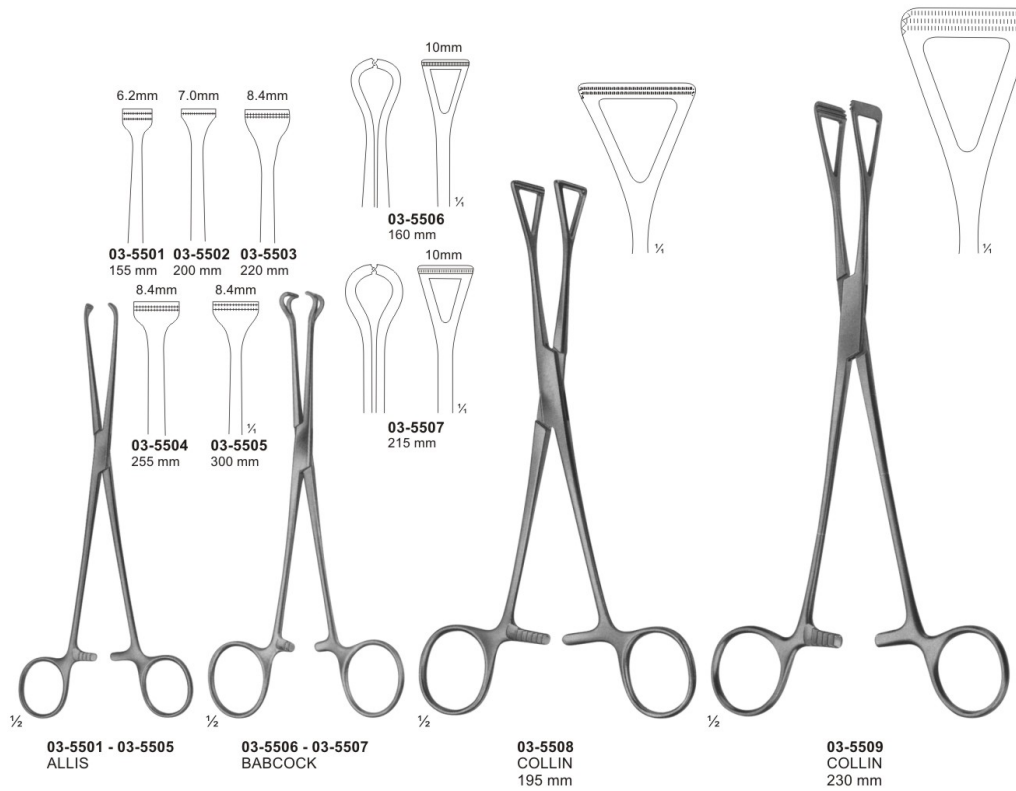

**Ultra - Light - Forceps, Dissecting Forceps
ATRAUMATA**

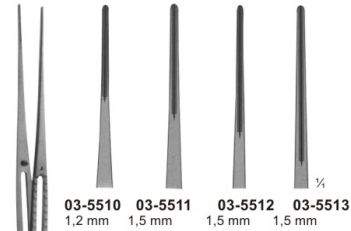

03-5510 - 03-5513
03-5510 150 mm
03-5511 200 mm
03-5512 240 mm
03-5513 300 mm



03-5514 - 03-5517
DE BAKEY
03-5514 150 mm
03-5515 200 mm
03-5516 240 mm
03-5517 300 mm

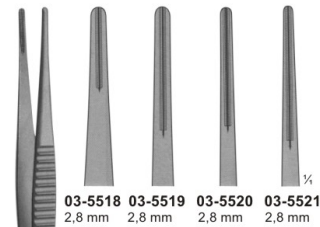

03-5518 - 03-5521
DE BAKEY
03-5518 150 mm
03-5519 200 mm
03-5520 240 mm
03-5521 300 mm



03-5522 - 03-5524
DE BAKEY
03-5522 200 mm
03-5523 240 mm
03-5524 300 mm

Intestinal Clamps for Children

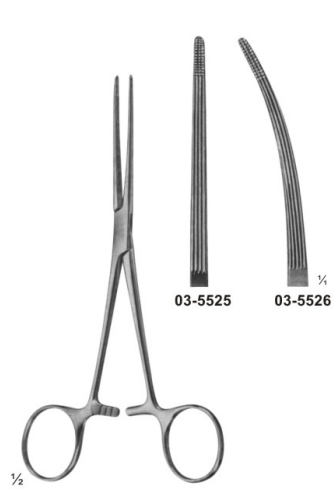

03-5525 - 03-5526
BAINBRIDGE
155 mm

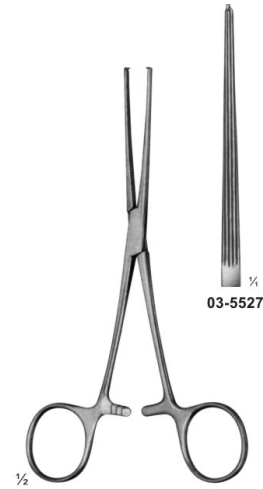

03-5527
ALLEN
155 mm

Atraumata

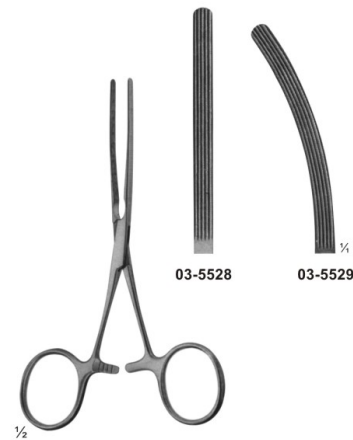

03-5528 - 03-5529
BABY-KOCHER
very elastic blades
130 mm

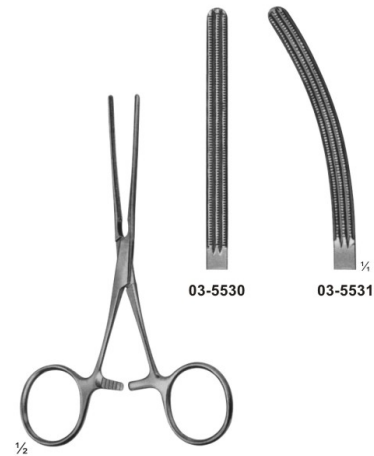

03-5530 - 03-5531
BABY-KOCHER
with elastic blades
130 mm

Intestinal Clamps, Soft Elastic

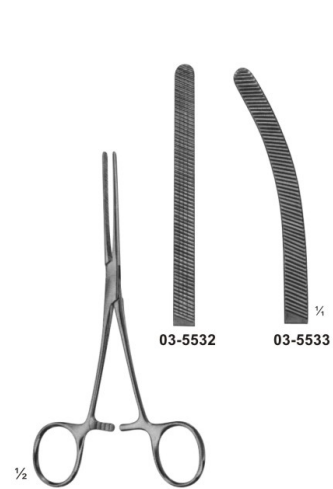

03-5532 - 03-5533
DOYEN
elastic
165 mm

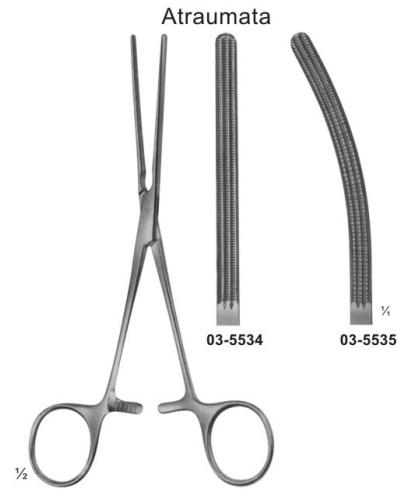

03-5534 - 03-5535
DOYEN
with elastic blades
170 mm

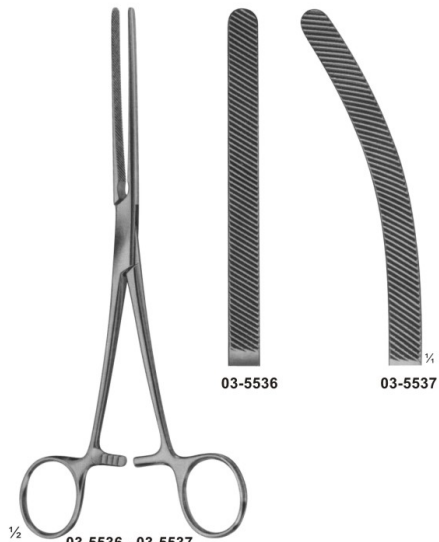

03-5536 - 03-5537
HARTMANN
with elastic blades
200 mm



03-5538 - 03-5539
HARTMANN
with elastic blades
200 mm

Intestinal Clamps, Soft elastic

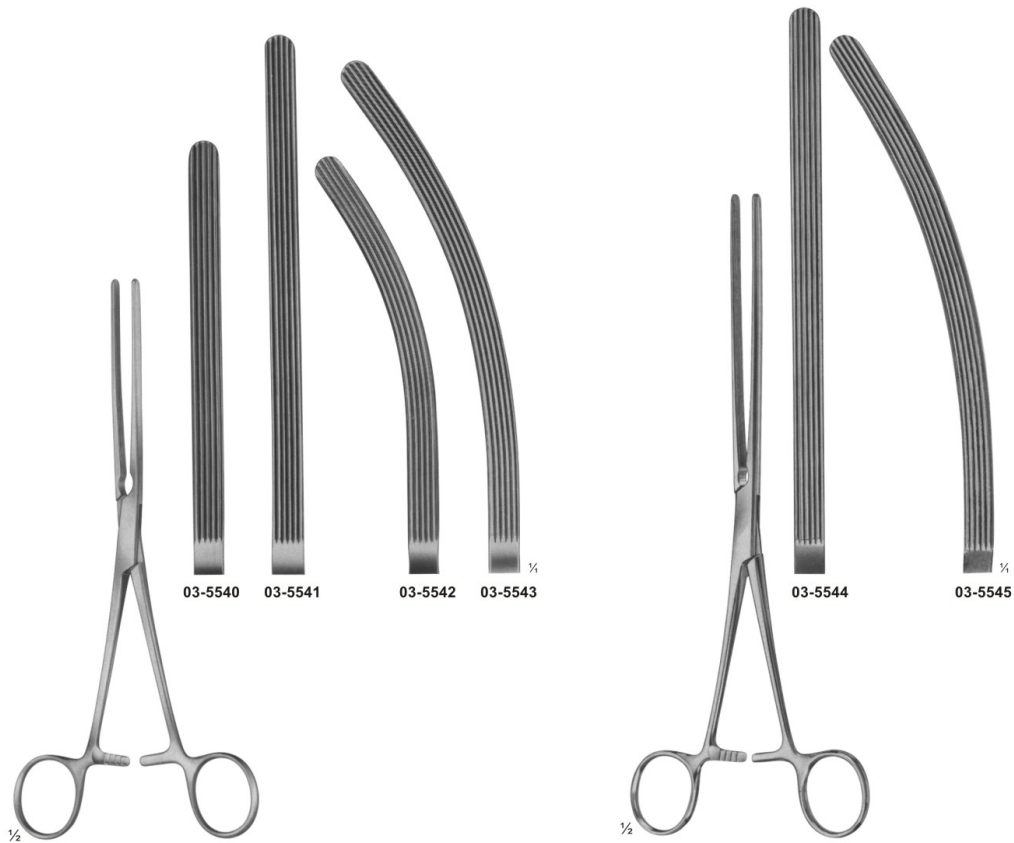

03-5540 - 03-5543
KOCHER
with elastic blades
03-5540-03-5542 210 mm
03-5541-03-5543 230 mm

03-5544 - 03-5545
DOYEN
with elastic blades
240 mm

Intestinal Clamps, Soft elastic

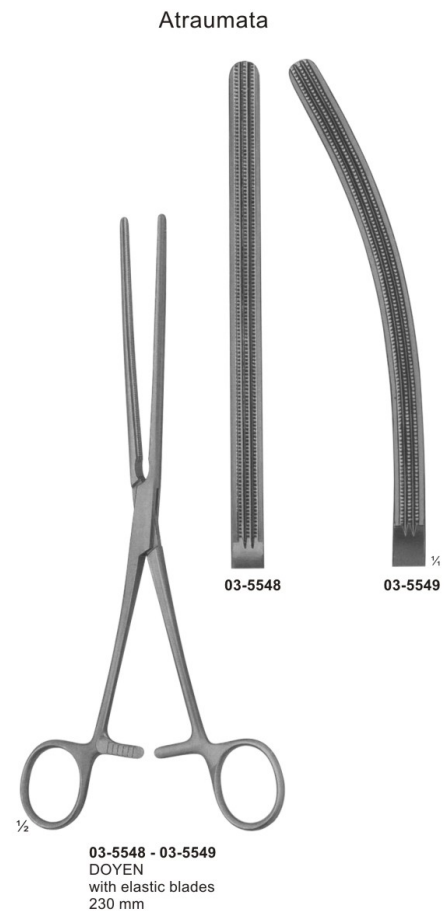
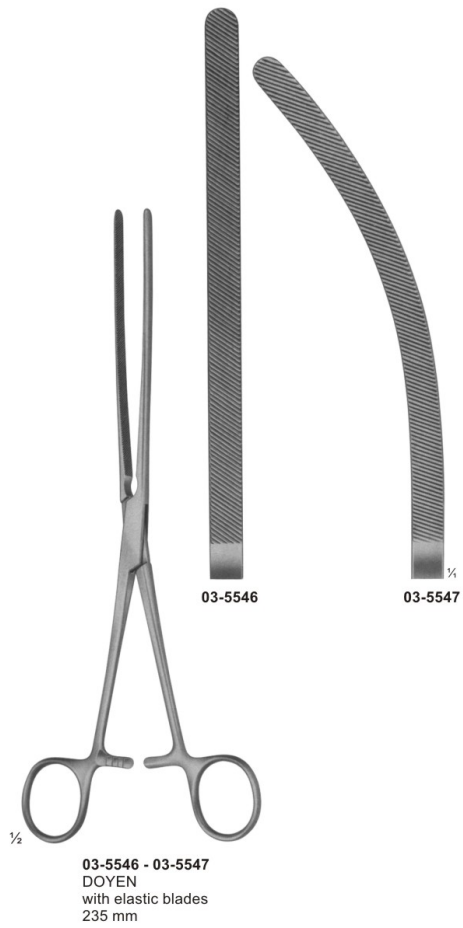

Intestinal Clamps, Soft elastic

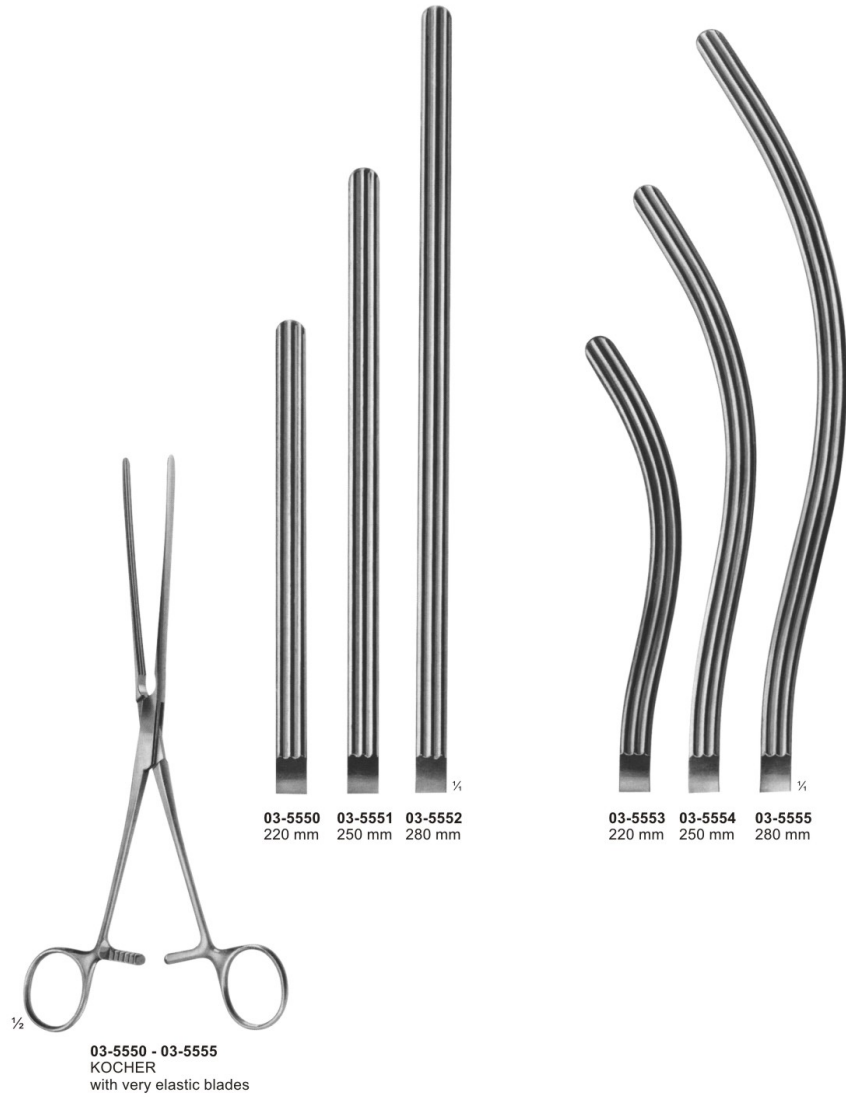

Intestinal Clamps, Soft elastic

Atraumata

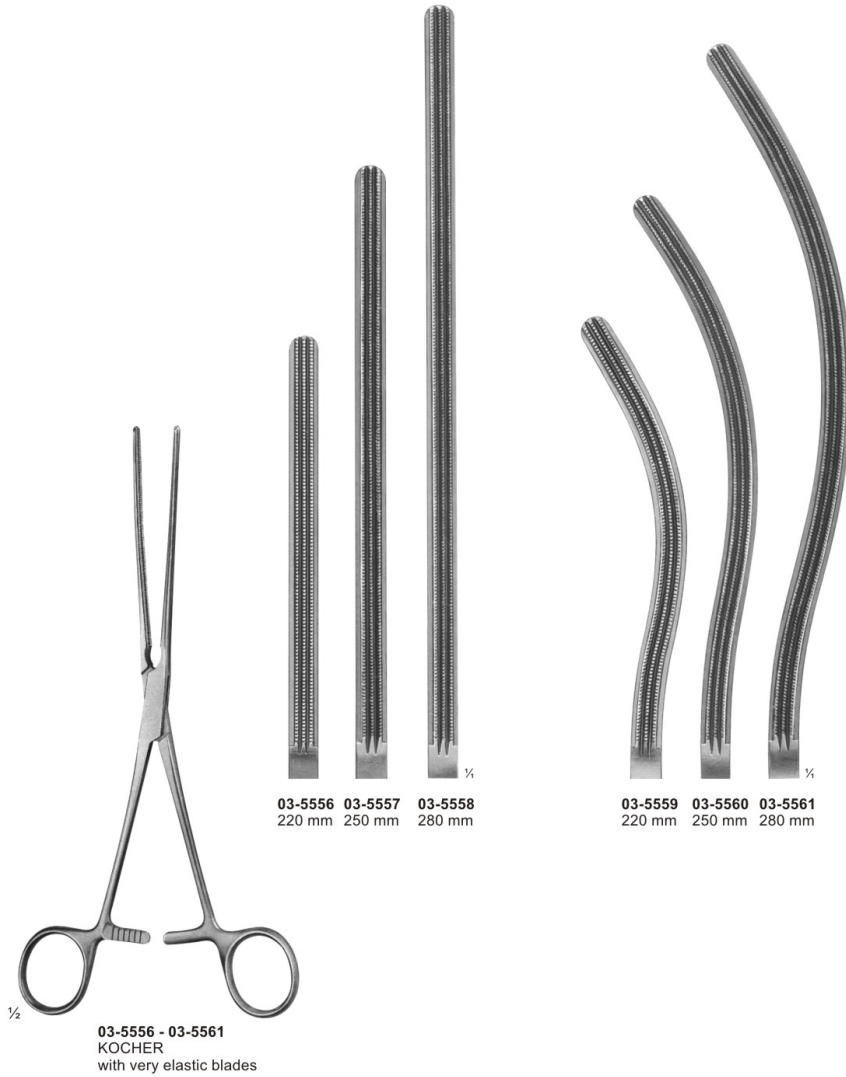

Intestinal Clamps

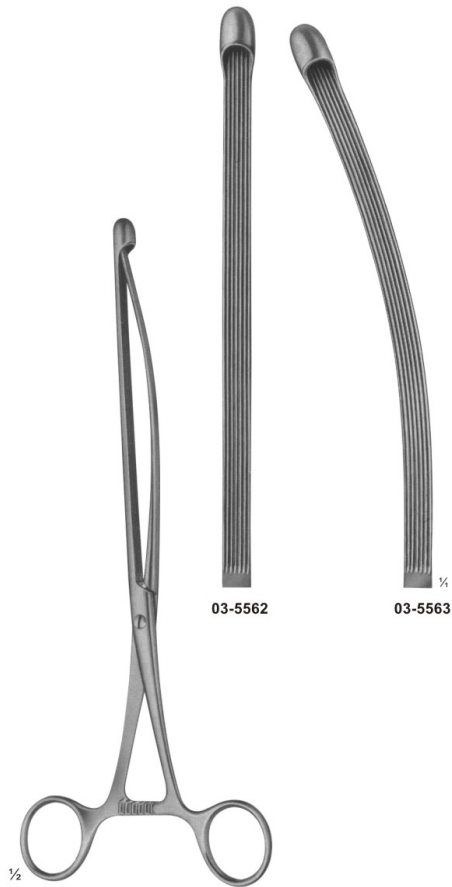

03-5562

03-5563

03-5562 - 03-5563
NUSSBAUM
with elastic blades
250 mm

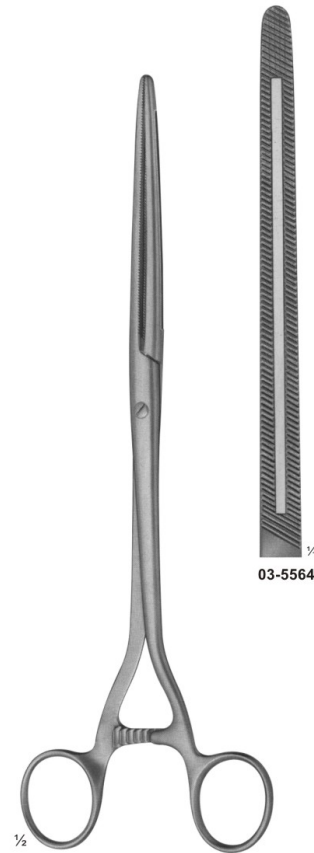

03-5564

03-5564
MOYNIHAN
280 mm

Intestinal Clamps

Atraumata

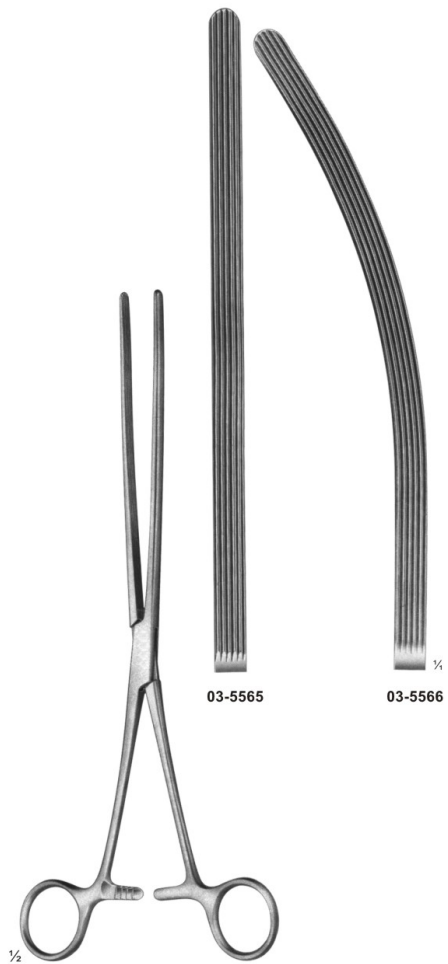

03-5565 - 03-5566
MAYO-ROBSON
hard elastic
250 mm

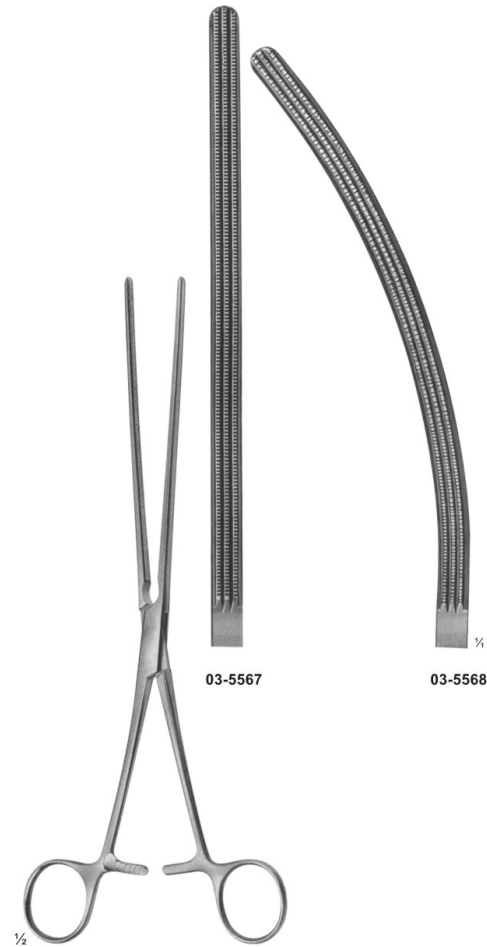

03-5567 - 03-5568
MAYO-ROBSON
250 mm

Gastro-Intestinal Forceps, twin



03-5569
LANE
300 mm

03-5570
LANE
300 mm

Stomach Clamps

Atraumata



03-5571

03-5572

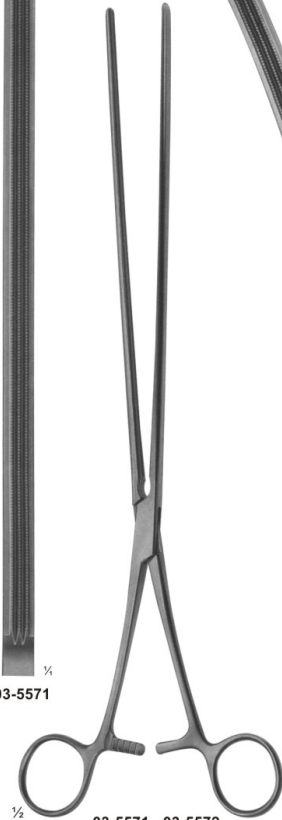

03-5571 - 03-5572
SCUDDER
330 mm



03-5573
KLEINSCHMIDT
Spur crushers and
Appendectomy clamps
130 mm

Intestinal and Pylorus Clamps



Anastomosis Forceps

Atraumata



03-5578
PARKER-KERR
anastomosis forceps
for colon resection
250 mm

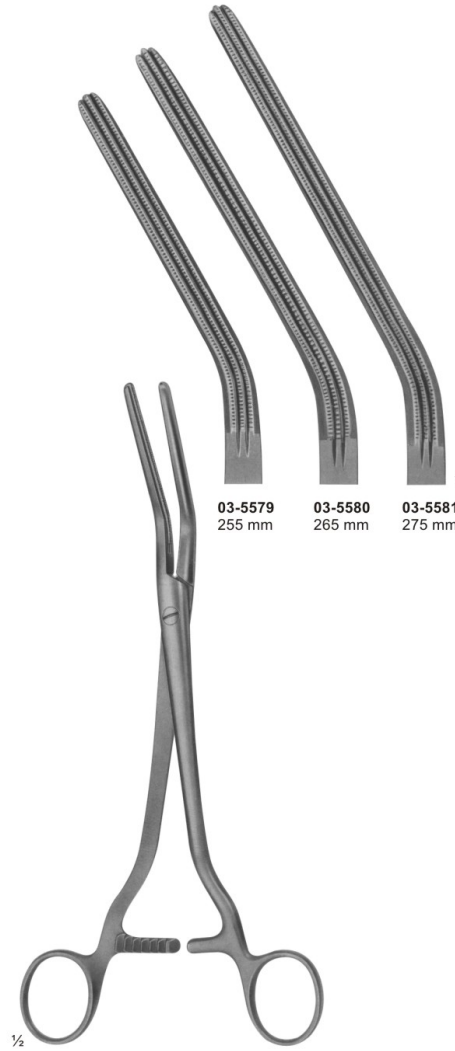

03-5579 255 mm
03-5580 265 mm
03-5581 275 mm

03-5579 - 03-5581
DICK
pressure clamps

Sigmoid Anastomosis Forceps



Atraumata Sigmoid Anastomosis Forceps

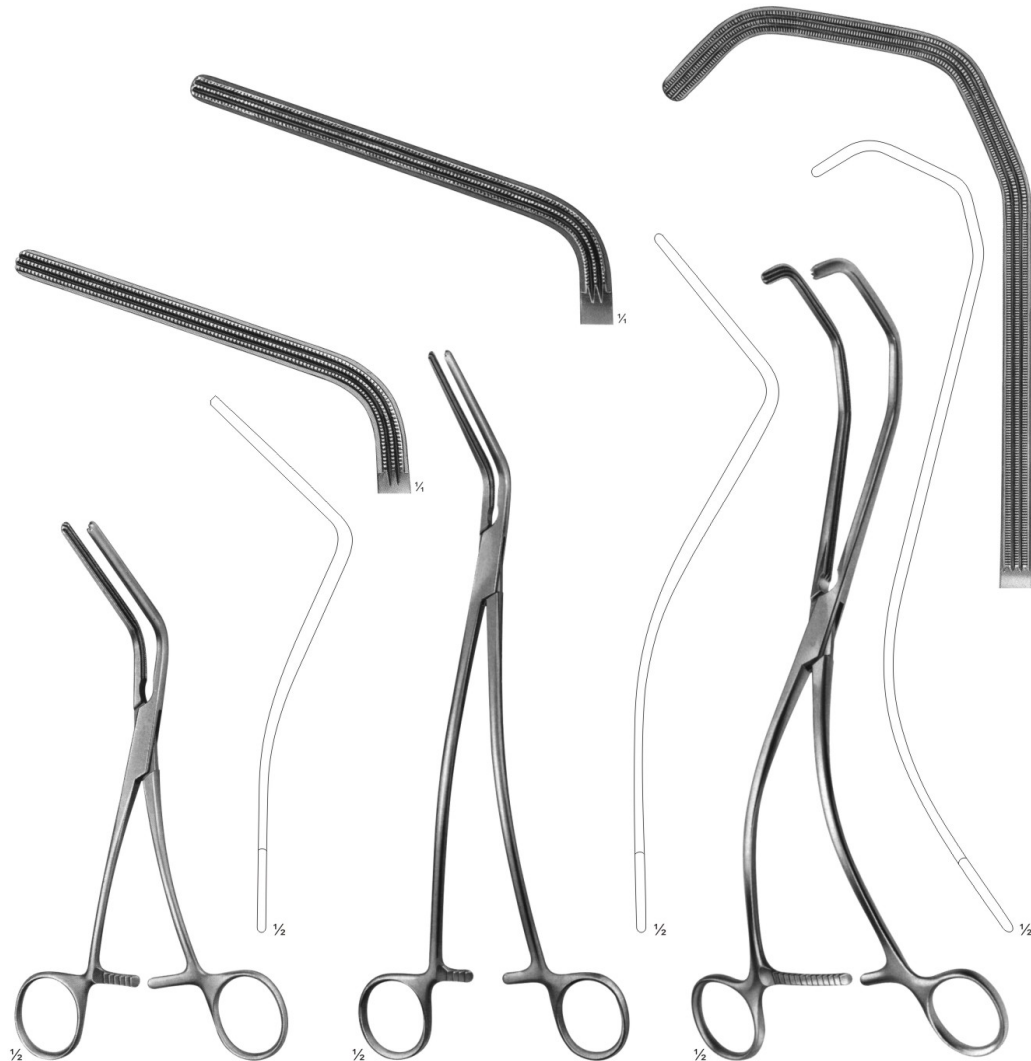

03-5585
MORRIS
175 mm

03-5586
DE BAKEY
(MORRIS modif.)
240 mm

03-5587
KERSTING
270 mm

Rectal Specula

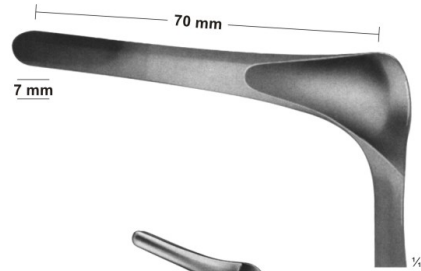

03-5588
KILLIAN
for children
145 mm



03-5589
SIMS
160 mm



03-5590
SIMS
160 mm

Rectal Specula

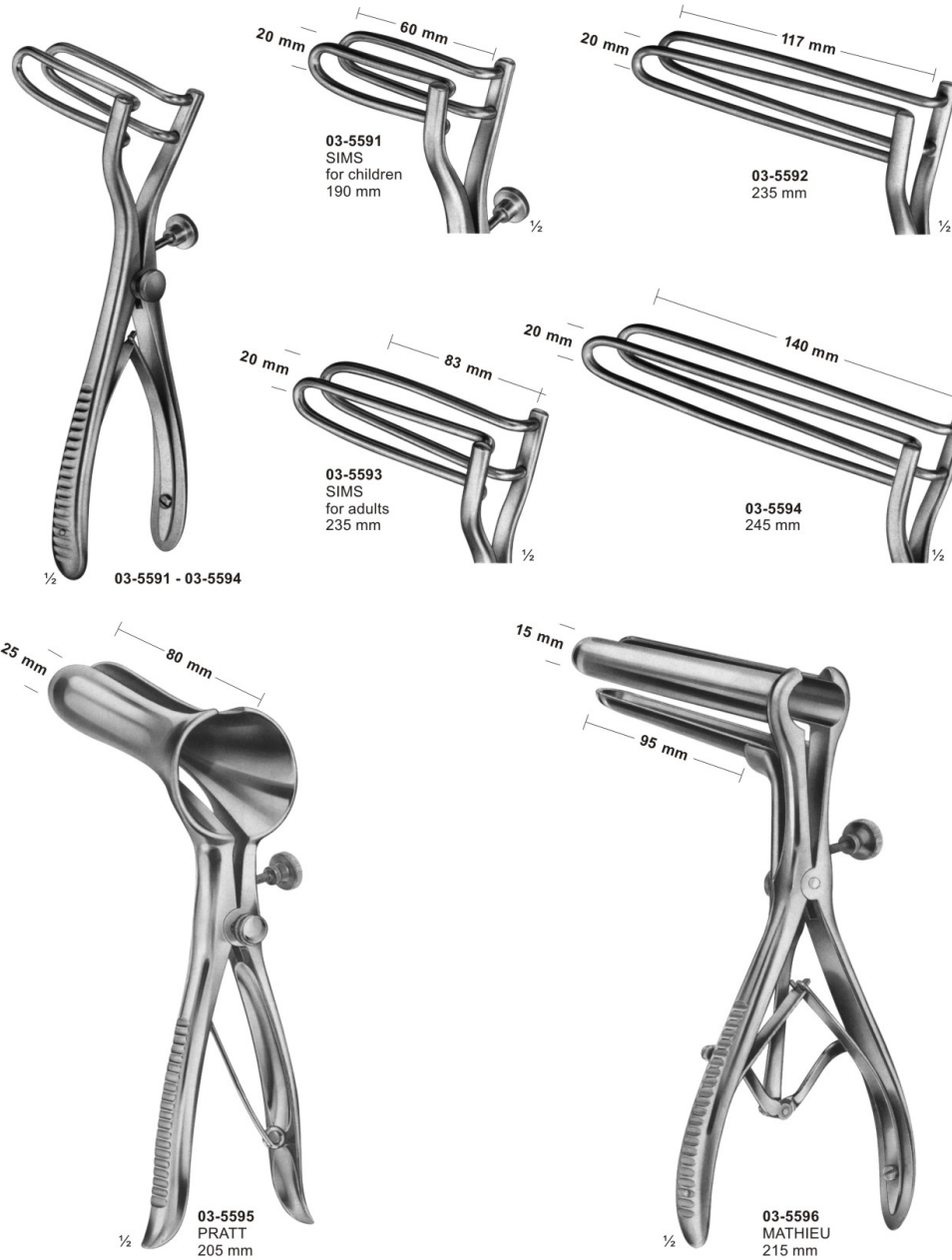

Anusopes-Sphincteroscopes, Proctoscopes



1/2
03-5597
IVES-FANSLER
Anuscope
145 mm
∅ 24mm



1/2
03-5598
KELLY
Sphincteroscope
160 mm
∅ 21mm



1/2
03-5599
KELLY
Sphincteroscope
160 mm
∅ 27mm

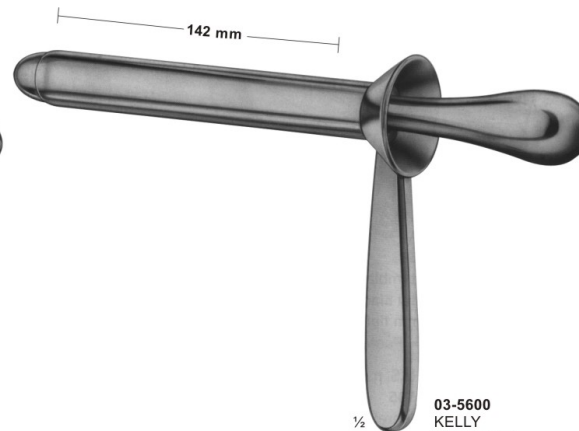

1/2
03-5600
KELLY
Proctoscope
140 mm
∅ 22mm

Biopsy forceps for rectum

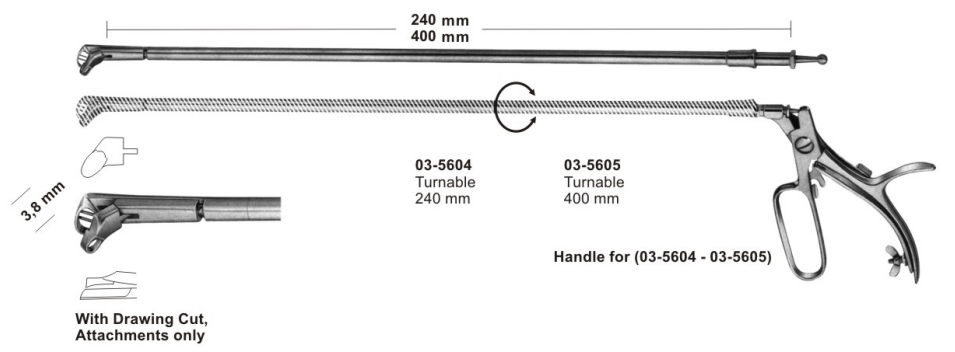
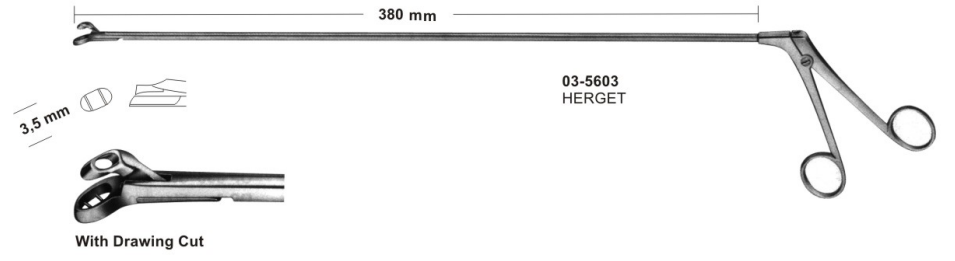
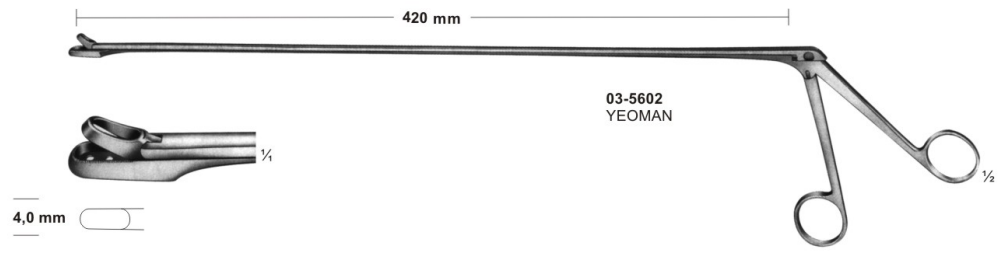
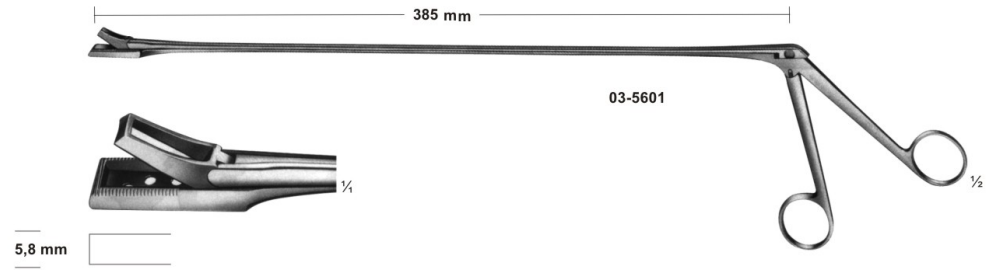

Biopsy Forceps & Swab Holders

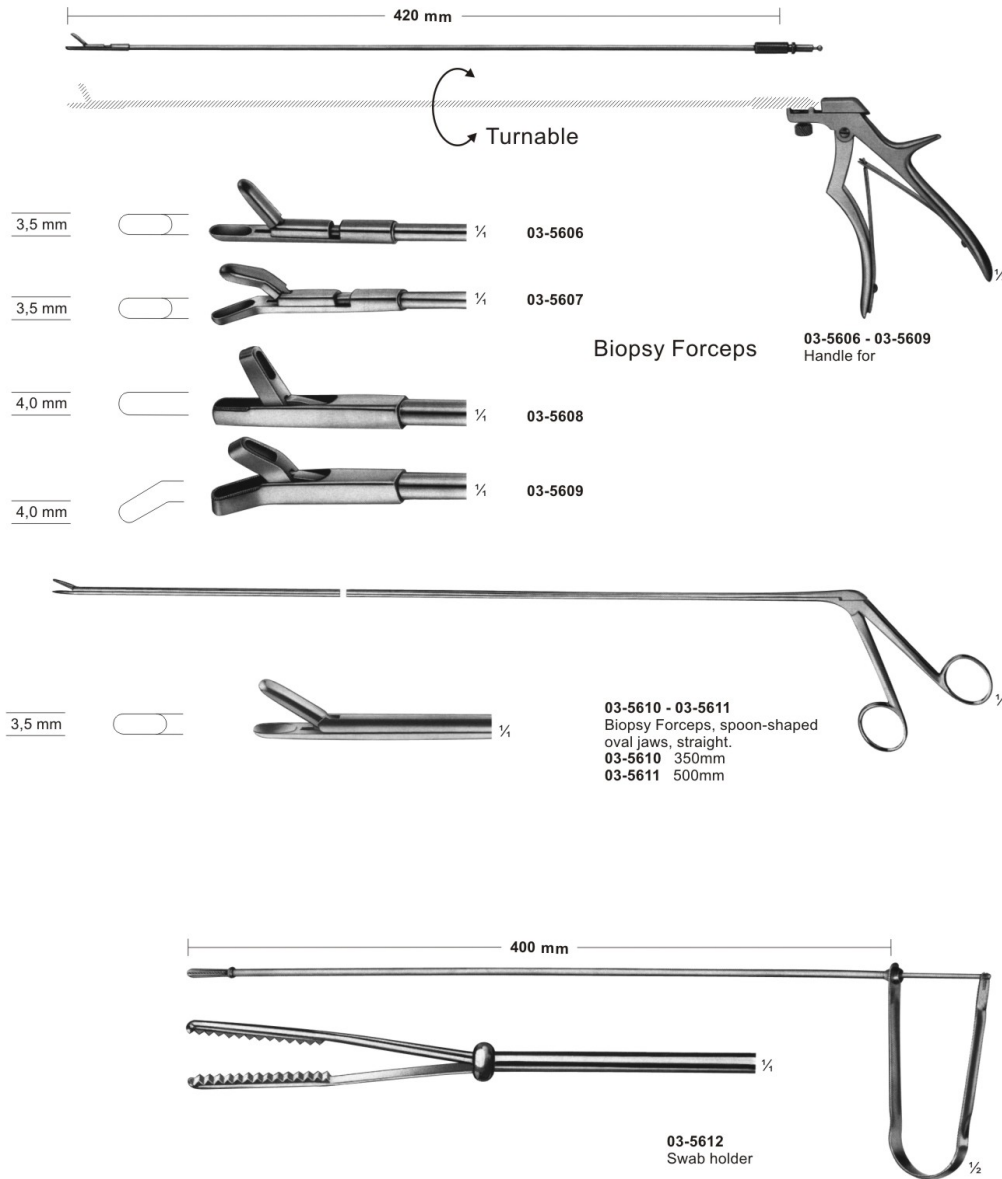

Haemorrhoidal Forceps



Haemorrhoidal Forceps

Atraumata

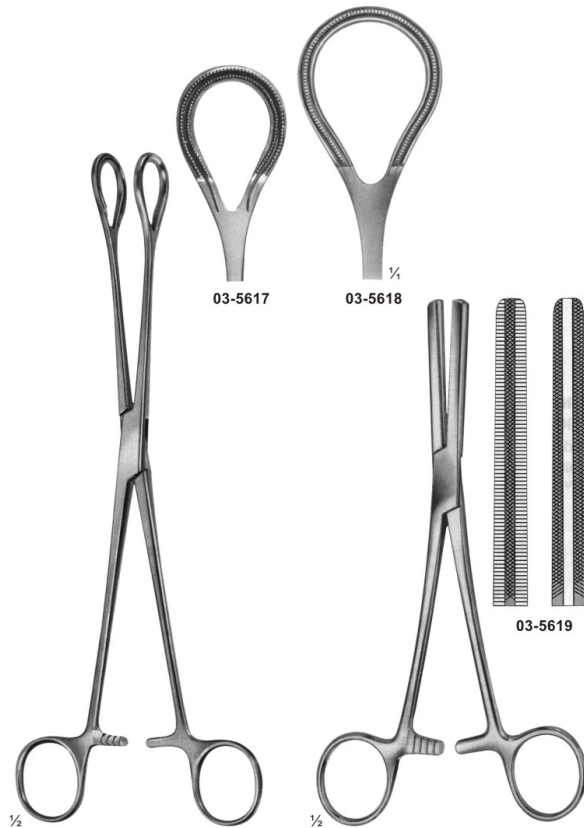

03-5617
250 mm
03-5618
270 mm

03-5619 - 03-5620
FERGUSSON
200 mm

Pressure Clamp



03-5621
RUDD
Haemorrhoidal ligator
with loading
attachment and 100
ligature rubber rings
315 mm

Gall Duct Forceps

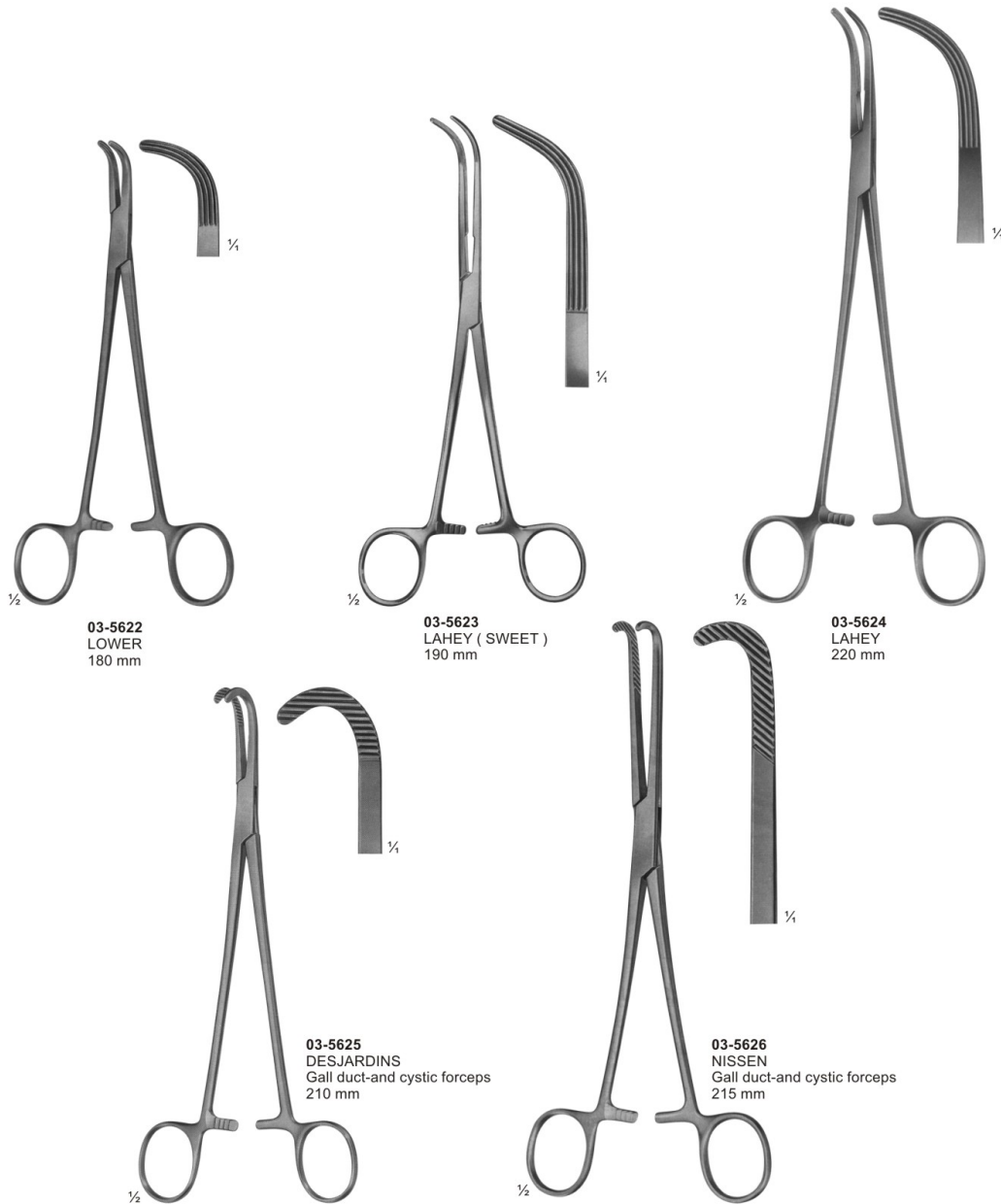

Gall Duct Forceps and Choledochus Forceps

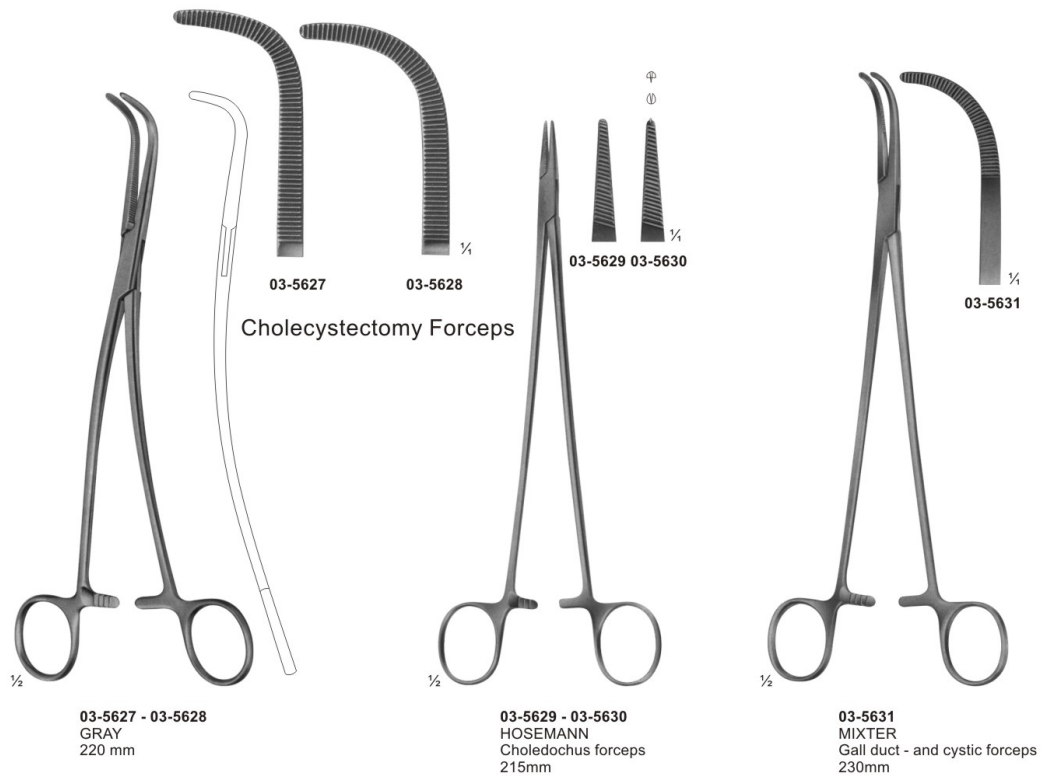

Gall Bladder Forceps and Gall Duct Scissors

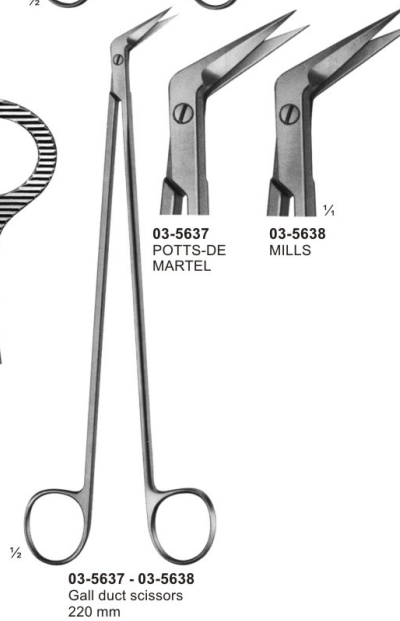
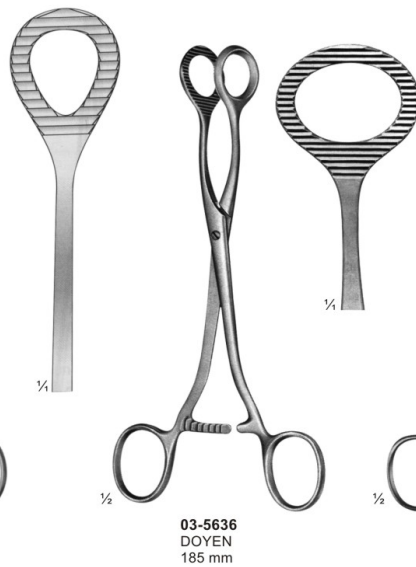
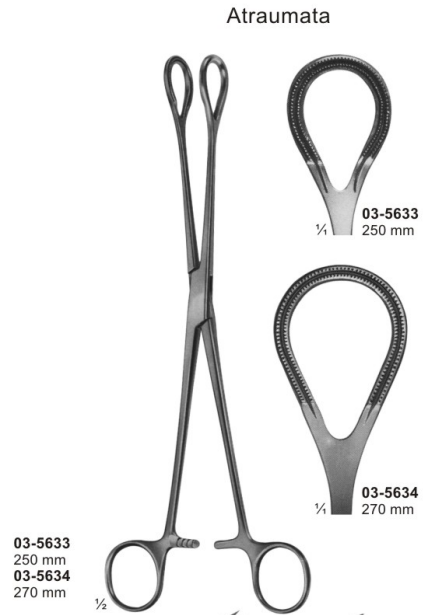
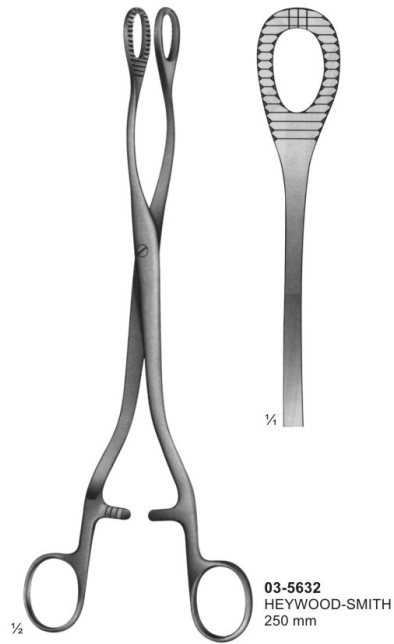

Gall Duct Probes

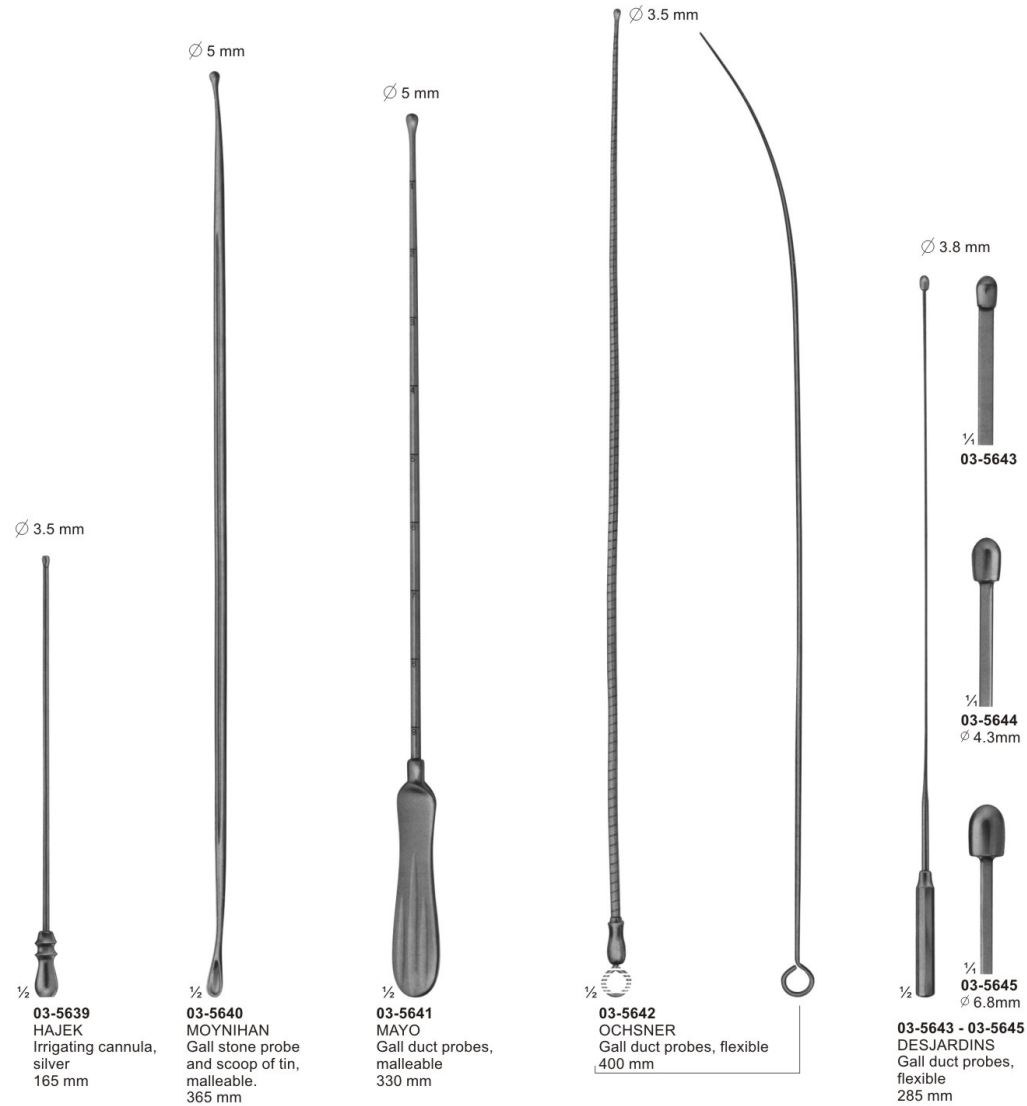

Gall Duct Dilators & Gall Stone Scoops

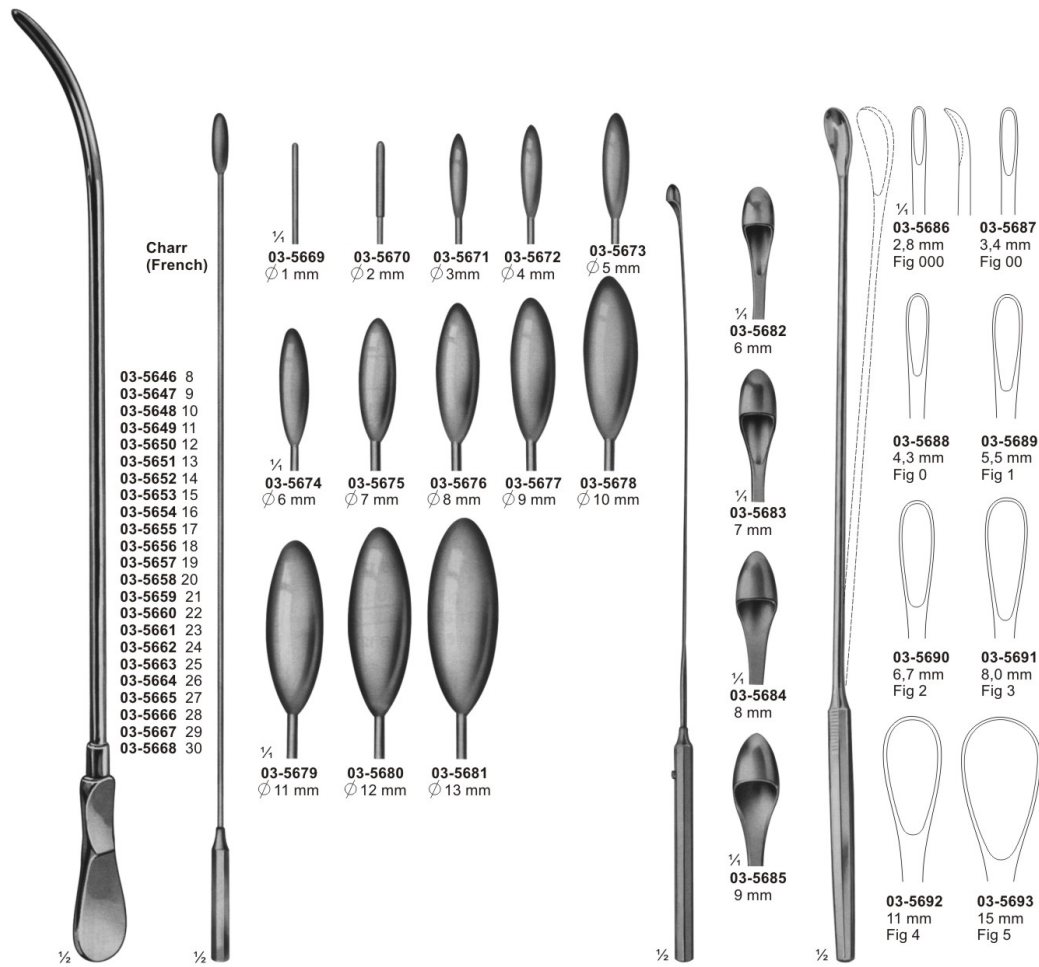

**Charr
(French)**

- 03-5646 8
- 03-5647 9
- 03-5648 10
- 03-5649 11
- 03-5650 12
- 03-5651 13
- 03-5652 14
- 03-5653 15
- 03-5654 16
- 03-5655 17
- 03-5656 18
- 03-5657 19
- 03-5658 20
- 03-5659 21
- 03-5660 22
- 03-5661 23
- 03-5662 24
- 03-5663 25
- 03-5664 26
- 03-5665 27
- 03-5666 28
- 03-5667 29
- 03-5668 30

- 1/4 03-5669 Ø 1 mm
- 03-5670 Ø 2 mm
- 03-5671 Ø 3 mm
- 03-5672 Ø 4 mm
- 03-5673 Ø 5 mm
- 1/4 03-5674 Ø 6 mm
- 03-5675 Ø 7 mm
- 03-5676 Ø 8 mm
- 03-5677 Ø 9 mm
- 03-5678 Ø 10 mm
- 1/4 03-5679 Ø 11 mm
- 03-5680 Ø 12 mm
- 03-5681 Ø 13 mm

- 1/4 03-5682 6 mm
- 1/4 03-5683 7 mm
- 1/4 03-5684 8 mm
- 1/4 03-5685 9 mm
- 1/4 03-5686 2,8 mm Fig 000
- 03-5687 3,4 mm Fig 00
- 03-5688 4,3 mm Fig 0
- 03-5689 5,5 mm Fig 1
- 03-5690 6,7 mm Fig 2
- 03-5691 8,0 mm Fig 3
- 03-5692 11 mm Fig 4
- 03-5693 15 mm Fig 5

03-5646 - 03-5668
DITTEL
Metal bougies and dilating sounds, stiff 345 mm

03-5669 - 03-5681
BAKES
Common bile duct dilators, malleable
03-5669-03-5673 315mm
03-5674-03-5681 320mm
Set of 9 pieces (**03-5671-03-5679**) in canvas roll

03-5682 - 03-5685
DESJARDINS
Probes and catch with flexible shaft 300 mm

03-5686 - 03-5693
LUER-KOERTE
modif with malleable shaft 310 mm

Gall Stone Forceps

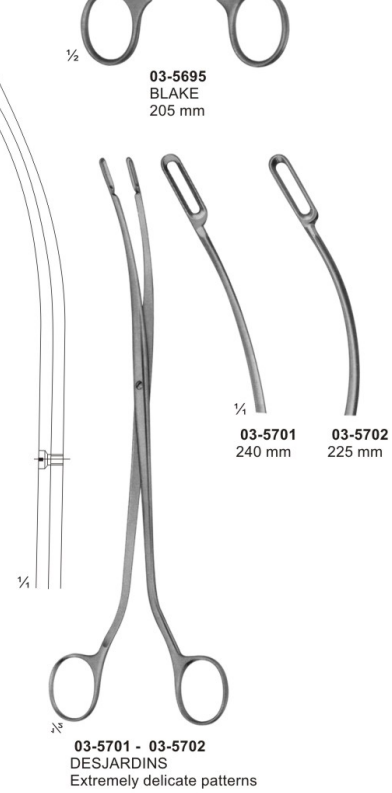
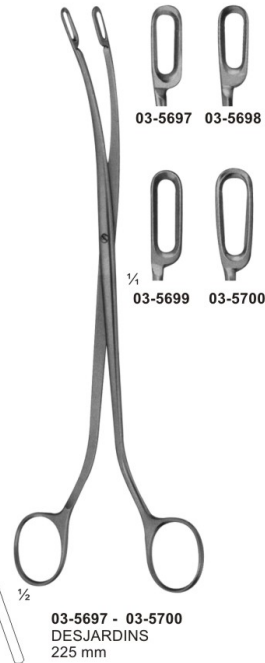
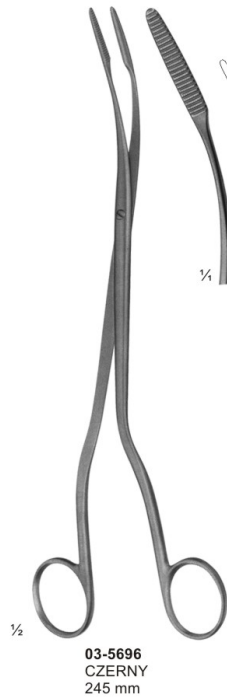
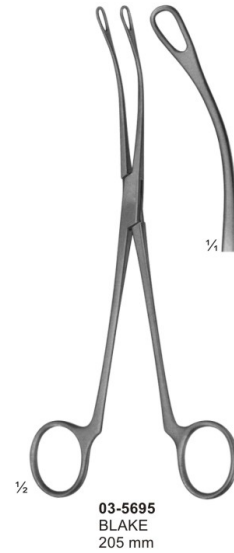
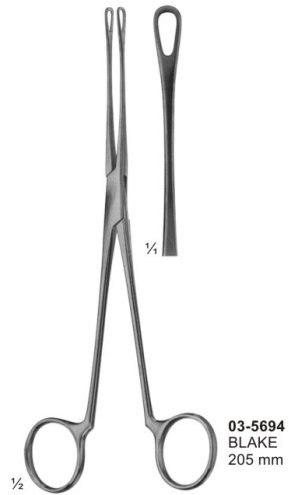

Kidney Clamps

Atraumata

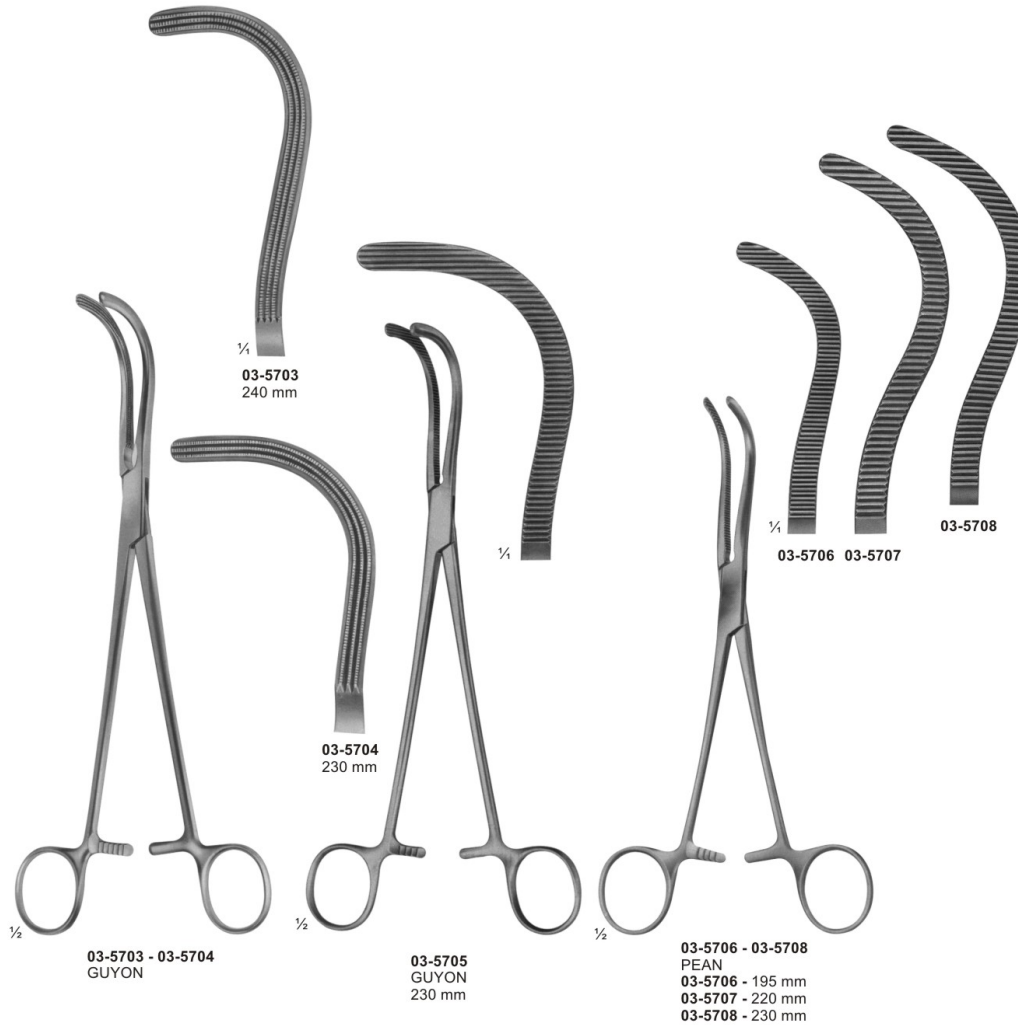

Kidney and Pedicle Clamps

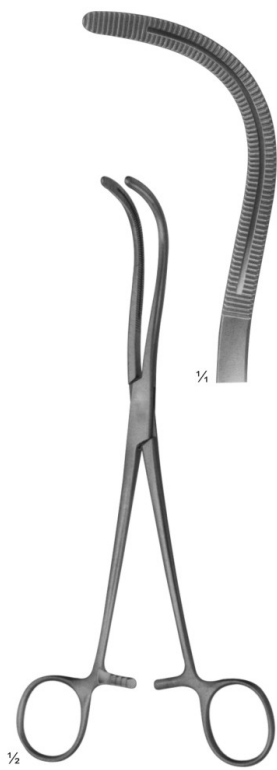

03-5709
STILLE
220 mm

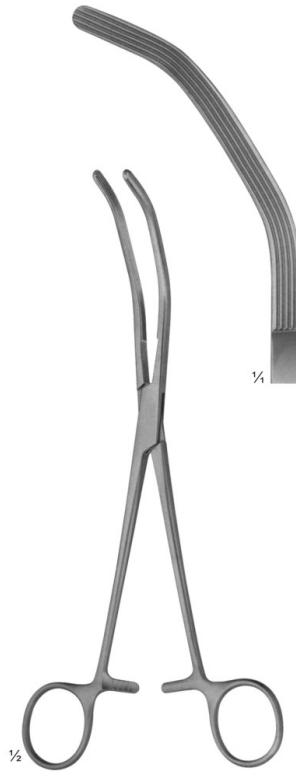

03-5710
HERRICK
225 mm



03-5711
WERTHEIM
225 mm

Kidney Elevating Forceps



03-5712
COLLIN
285 mm



03-5713
DARTIGUES
255 mm

Kidney Stone Forceps

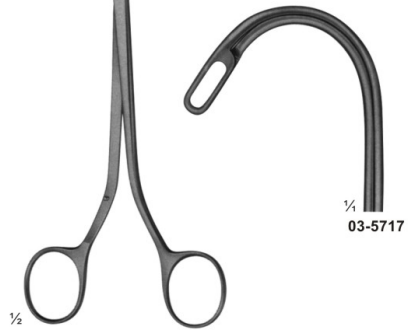

03-5714 - 03-5717
RANDALL
225 mm



03-5718 - 03-5719
RANDALL
190 mm

Bladder Retractors

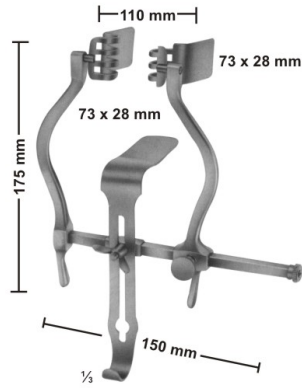

03-5720
JUDD-MASSON
Bladder-and suprapubic
retractor

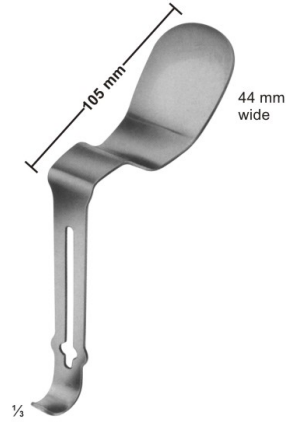

03-5721
MILLIN
Center blade for (05-6993)
retro pubic prostatectomy



03-5722
MILLIN
Bladder retractor
03-5722 Spreader only
03-5723 Blades 57x25mm
03-5724 Blades 82x25mm
03-5725 Center blade 105x45mm

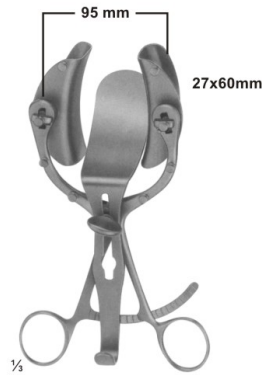

03-5726
LEGUEU
Bladder retractor
Center blade
80 x 31 mm



03-5727
LEGUEU
Bladder spatula
260 mm

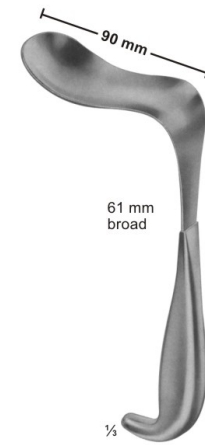

03-5728
KOCHER
Bladder spatula
235 mm

Genito-Urinary Instruments



03-5729
MATHIEU
Foreign body forceps
Length of shaft
190 mm

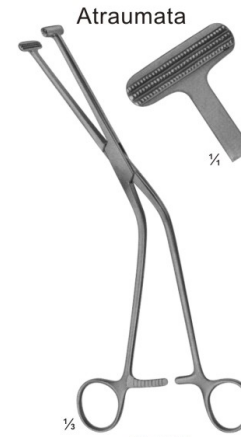

03-5730
MILLIN
Lobe grasping
forceps
235 mm

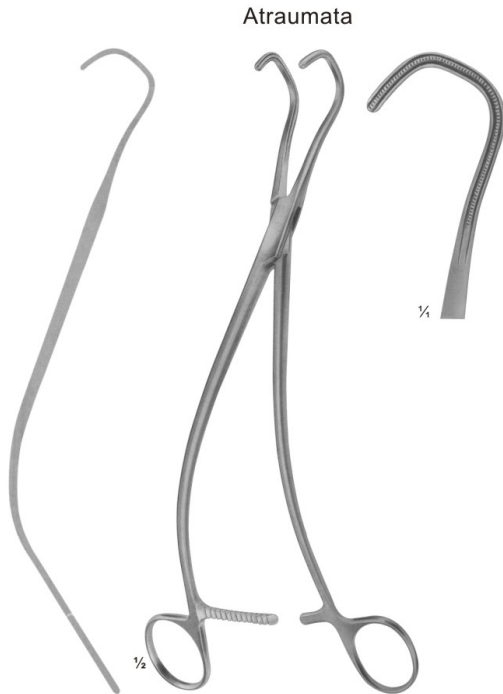

Atraumata

03-5731
Ureter forceps
240 mm

Atraumata

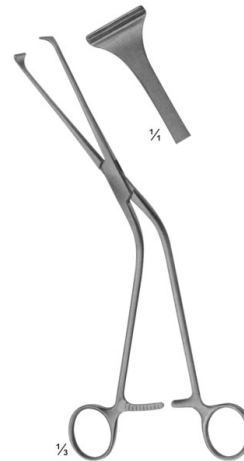

03-5732
MILLIN
Lobe grasping
forceps
245 mm



03-5733
MILLIN
Bladder neck spreader
285 mm

Genito-Urinary Instruments



03-5734
GUYON
Catheter guide
(introducer)
365 mm

**Charr.
(French)**

- 03-5735 6
- 03-5736 7
- 03-5737 8
- 03-5738 9
- 03-5739 10
- 03-5740 11
- 03-5741 12
- 03-5742 13
- 03-5743 14
- 03-5744 15
- 03-5745 16
- 03-5746 18
- 03-5747 20

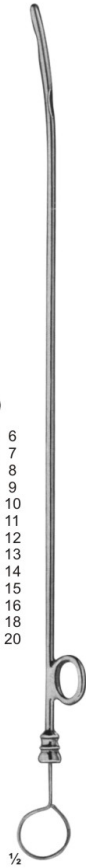

03-5735 - 03-5747
Female catheters,
metal
160 mm

**Charr.
(French)**

- 03-5748 8
- 03-5749 9
- 03-5750 10
- 03-5751 11
- 03-5752 12
- 03-5753 13
- 03-5754 14
- 03-5755 15
- 03-5756 16
- 03-5757 17
- 03-5758 18
- 03-5759 19
- 03-5760 20
- 03-5761 21
- 03-5762 22
- 03-5763 23
- 03-5764 24
- 03-5765 25
- 03-5766 26
- 03-5767 27
- 03-5768 28
- 03-5769 29
- 03-5770 30

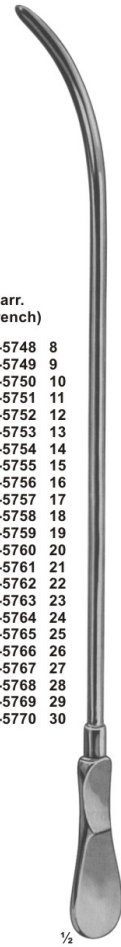

03-5748 - 03-5770
DITTEL
Urethral bougies
and dilating sounds
345 mm

- 03-5771 Ben. 24/Charr. 12
- 03-5772 Ben. 25
- 03-5773 Ben. 26/Charr. 13
- 03-5774 Ben. 27
- 03-5775 Ben. 28/Charr. 14
- 03-5776 Ben. 29
- 03-5777 Ben. 30/Charr. 15
- 03-5778 Ben. 31
- 03-5779 Ben. 32/Charr. 16
- 03-5780 Ben. 33
- 03-5781 Ben. 34/Charr. 17
- 03-5782 Ben. 35
- 03-5783 Ben. 36/Charr. 18
- 03-5784 Ben. 37
- 03-5785 Ben. 38/Charr. 19
- 03-5786 Ben. 39
- 03-5787 Ben. 40/Charr. 20
- 03-5788 Ben. 41
- 03-5789 Ben. 42/Charr. 21
- 03-5790 Ben. 43
- 03-5791 Ben. 44/Charr. 22
- 03-5792 Ben. 45
- 03-5793 Ben. 46/Charr. 23
- 03-5794 Ben. 47
- 03-5795 Ben. 48/Charr. 24
- 03-5796 Ben. 49
- 03-5797 Ben. 50/Charr. 25
- 03-5798 Ben. 51
- 03-5799 Ben. 52/Charr. 26
- 03-5800 Ben. 53
- 03-5801 Ben. 54/Charr. 27
- 03-5802 Ben. 55
- 03-5803 Ben. 56/Charr. 28
- 03-5804 Ben. 57
- 03-5805 Ben. 58/Charr. 29
- 03-5806 Ben. 59
- 03-5807 Ben. 60/Charr. 30

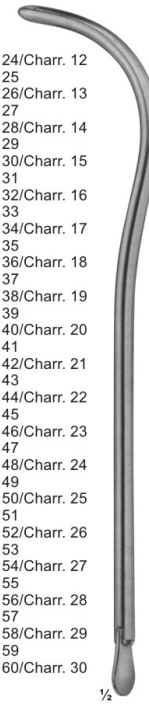

03-5771 - 03-5807
GUYON
Urethral bougies
and dilating sounds,
without filiform guides,
with thread in tip
255 mm

Genito-Urinary Instruments & Circumcision Clamps



03-5808
GUYON
Set of urethral bougies and dilating sounds,
in metal case, with lift out rack and bottom
rack, containing 21 urethral and dilating sounds, metal.

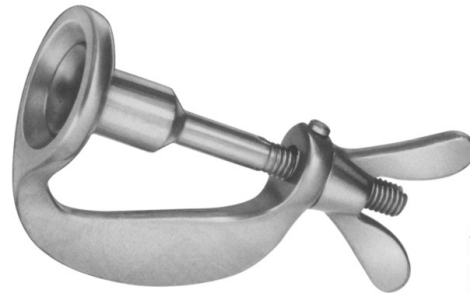

03-5809 - 03-5811
WINKELMANN
03-5809 ∅ 12mm
03-5810 ∅ 16mm
03-5811 ∅ 20mm

Circumcision Clamps

Assisted by two haemostats or ligatures the foreskin is pushed over the bellshaped protection - rod and the glans is placed into it.
By now, the wing - nut is tightened as close as possible, so the foreskin in annular compressed. The foreskin is cut of with a scalpel, right next to the compression ring. The circumcising clamp remains a few minutes to avoid bleeding. In case that any large vein, specially the frenular artery, is cut through, a ligature must be set.
The advantage of the method described is the cosmetically favourable scar which is left after rejection of the small necrotized portion.

Trocars

Luer Lock

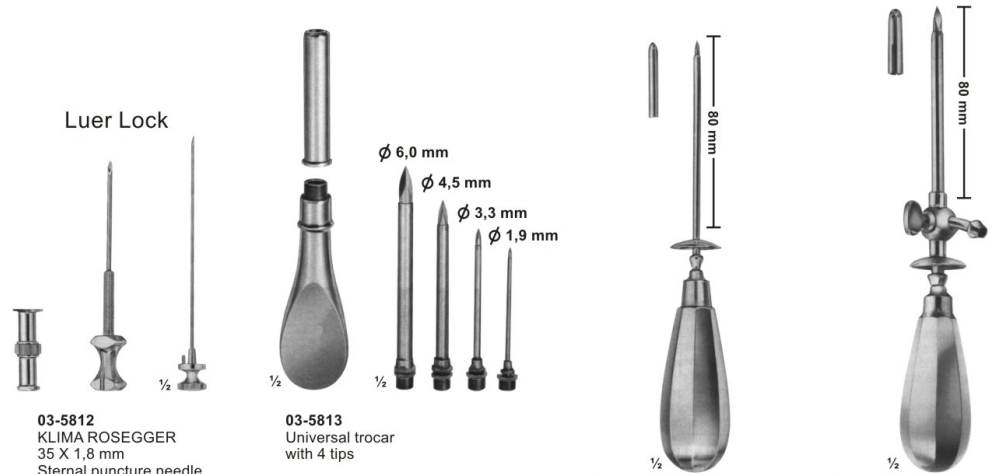

03-5812
KLIMA ROSEGGER
35 X 1,8 mm
Sternal puncture needle

03-5813
Universal trocar
with 4 tips

Ø 6,0 mm
Ø 4,5 mm
Ø 3,3 mm
Ø 1,9 mm

03-5814 - 03-5818
NELSON

	Inside diam	Outside diam
03-5814	2,2 mm	3,0 mm
03-5815	3,0 mm	4,0 mm
03-5816	4,0 mm	5,0 mm
03-5817	5,0 mm	6,0 mm
03-5818	5,5 mm	6,5 mm

for hydrocele and abdominal puncture

03-5819 - 03-5822

	Inside diam	Outside diam
03-5819	2,2 mm	3,0 mm
03-5820	3,0 mm	4,0 mm
03-5821	4,0 mm	5,0 mm
03-5822	5,0 mm	6,0 mm

for abdominal puncture,
with stop-cock and lateral drain

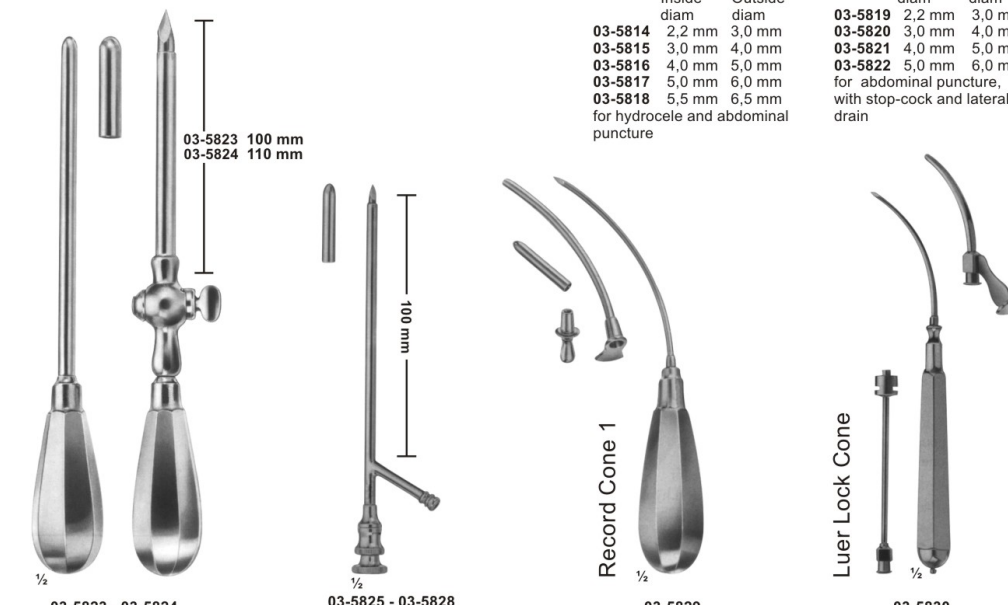

03-5823 100 mm
03-5824 110 mm

03-5825 100 mm

03-5823 - 03-5824
BUELAU

	Inside diam	Outside diam
03-5823	6,5 mm	8,0 mm
03-5824	9,0 mm	10,0 mm

Empyema trocar

03-5825 - 03-5828
OCHSNER

	Inside diam	Outside diam
03-5825	3,0 mm	4,0 mm
03-5826	3,6 mm	4,6 mm
03-5827	4,3 mm	5,3 mm
03-5828	5,0 mm	6,0 mm

Gall bladder trocars

Record Cone 1

03-5829
PIERCE
Antrum trocar
Ø 4,0 mm

Luer Lock Cone

03-5830
COAKLEY
Antrum trocar
Ø 3,0 mm

Vaginal specula

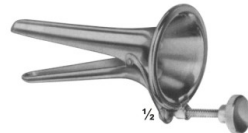

04-6001
COLLIN
for children
53 x 10 mm

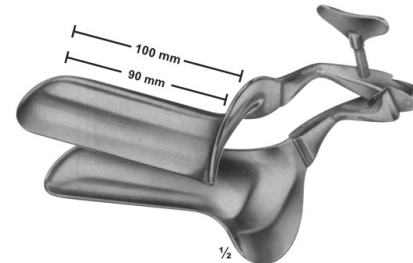

04-6002 - 04-6005
COLLIN

04-6002	100/90mm	28 mm
04-6003	100/90mm	32 mm
04-6004	105/95mm	35 mm
04-6005	115/105mm	40 mm

 Total length/working width length

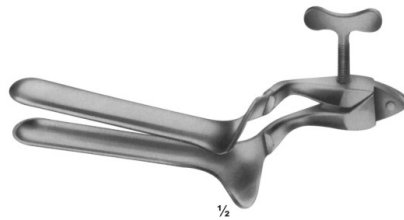

04-6006
COLLIN
for virgins
95/85 x 18 mm

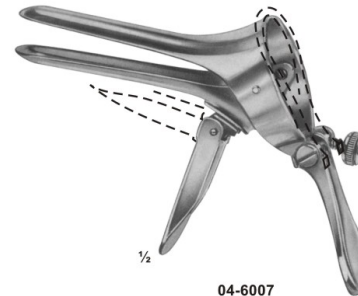

04-6007
CUSCO
for virgins
75 x 17 mm

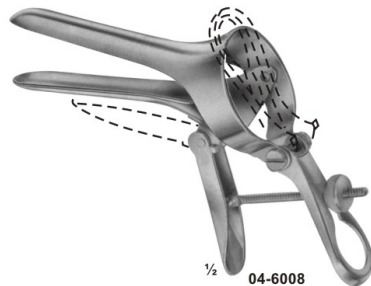

04-6008
CUSCO
for virgins
75 x 17 mm

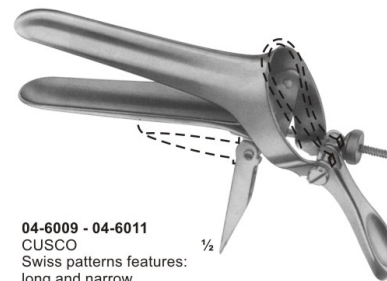

04-6009 - 04-6011
CUSCO
Swiss patterns features:
long and narrow

04-6009	92x23-25 mm
04-6010	100x25-27 mm
04-6011	110x27-30 mm

Vaginal Specula



04-6012 - 04-6015
CUSCO
STANDARD
04-6012 80X24 mm
04-6013 80X32 mm
04-6014 90X36 mm
04-6015 110X37 mm



04-6016 - 04-6019
CUSCO
04-6016 80X24 mm
04-6017 80X32 mm
04-6018 90X36 mm
04-6019 110X37 mm

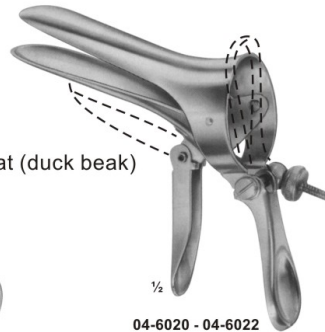

Flat (duck beak)

04-6020 - 04-6022
CUSCO
04-6020 80X32 mm
04-6021 90X37 mm
04-6022 115X37 mm



04-6023 - 04-6024
SEYFFERT
04-6023 100X17 mm
04-6024 110X33 mm
230 mm

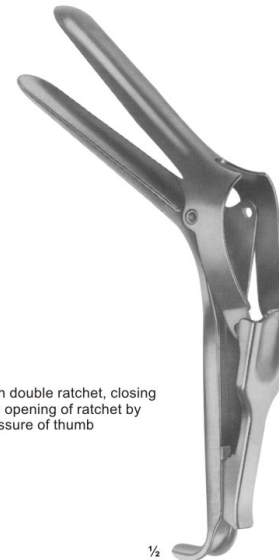

With double ratchet, closing and opening of ratchet by pressure of thumb

04-6025
SEMM
for children and virgins
180 mm
90X14-18mm

Vaginal Specula, Sets, Upper & Lower Blades

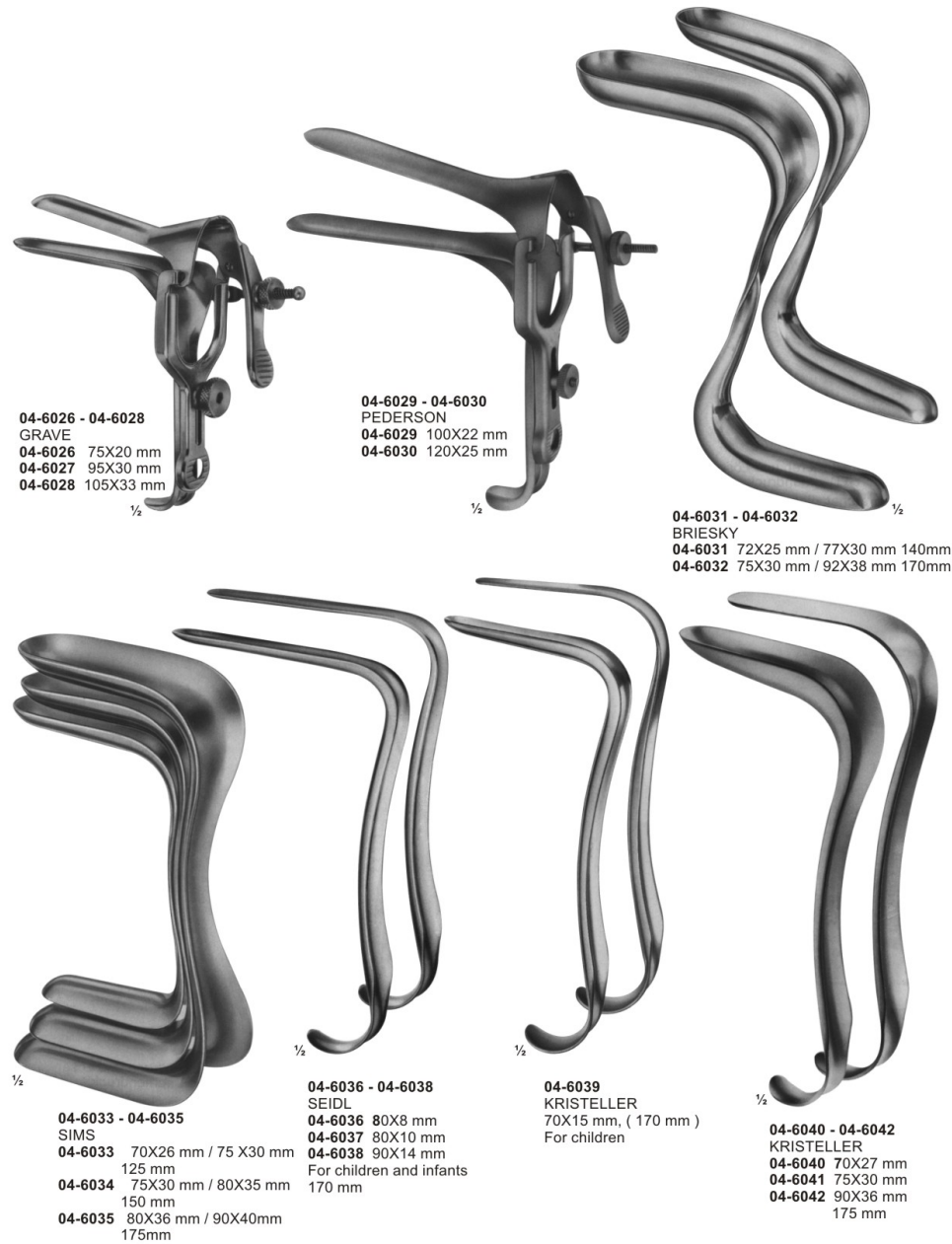

04-6026 - 04-6028
GRAVE
04-6026 75X20 mm
04-6027 95X30 mm
04-6028 105X33 mm

04-6029 - 04-6030
PEDERSON
04-6029 100X22 mm
04-6030 120X25 mm

04-6031 - 04-6032
BRIESKY
04-6031 72X25 mm / 77X30 mm 140mm
04-6032 75X30 mm / 92X38 mm 170mm

04-6033 - 04-6035
SIMS
04-6033 70X26 mm / 75 X30 mm
125 mm
04-6034 75X30 mm / 80X35 mm
150 mm
04-6035 80X36 mm / 90X40mm
175mm

04-6036 - 04-6038
SEIDL
04-6036 80X8 mm
04-6037 80X10 mm
04-6038 90X14 mm
For children and infants
170 mm

04-6039
KRISTELLER
70X15 mm, (170 mm)
For children

04-6040 - 04-6042
KRISTELLER
04-6040 70X27 mm
04-6041 75X30 mm
04-6042 90X36 mm
175 mm

Vaginal Specula-Sets, upper and lower blades



Vaginal Specula-upper and lower blades

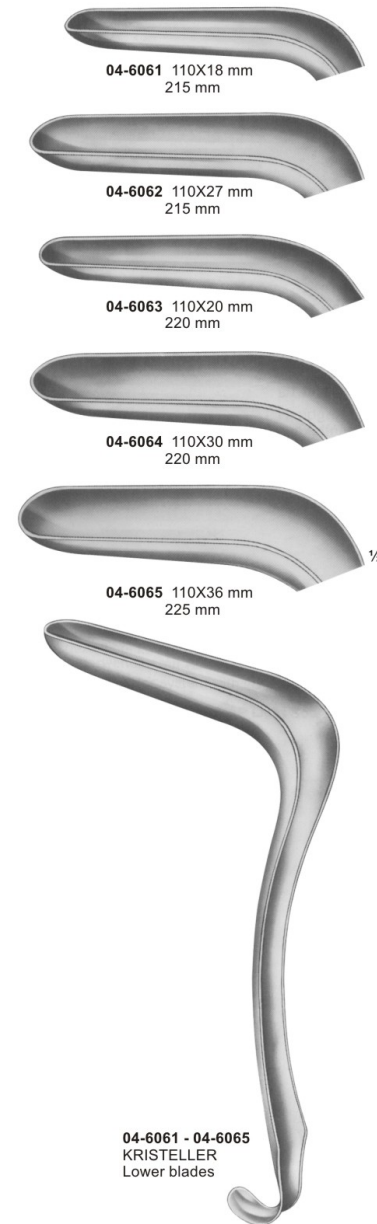
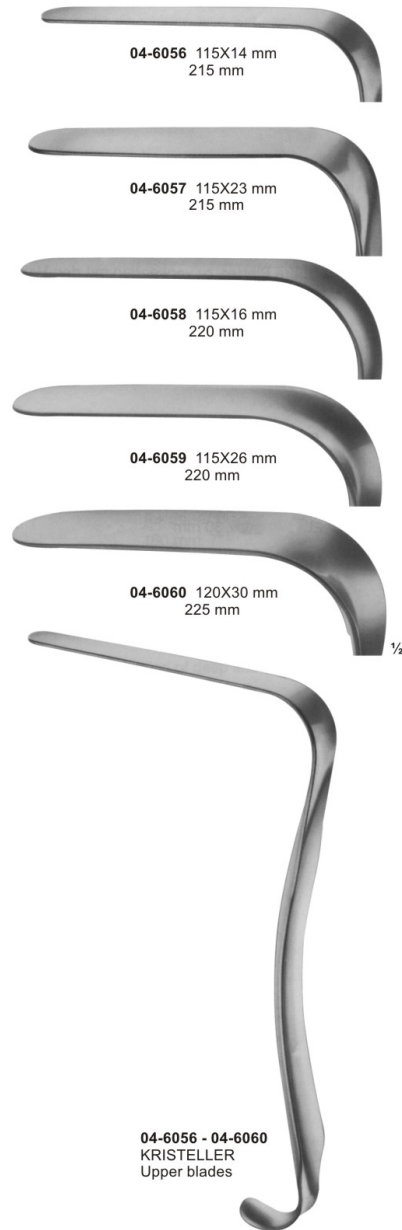

Vaginal Specula



04-6066
80 X 28 mm



04-6067
85 X 35 mm



04-6068
85 X 40 mm



Slightly Concave

1/2

04-6066 - 04-6068
KRISTELLER
205 mm



04-6069
76 X 38 mm



04-6070
89 X 38 mm



04-6071
102 X 38 mm



Slightly Concave

1/2

04-6069 - 04-6071
JACKSON
175 mm

Vaginal Specula-for children & virgins
Vario Retractor

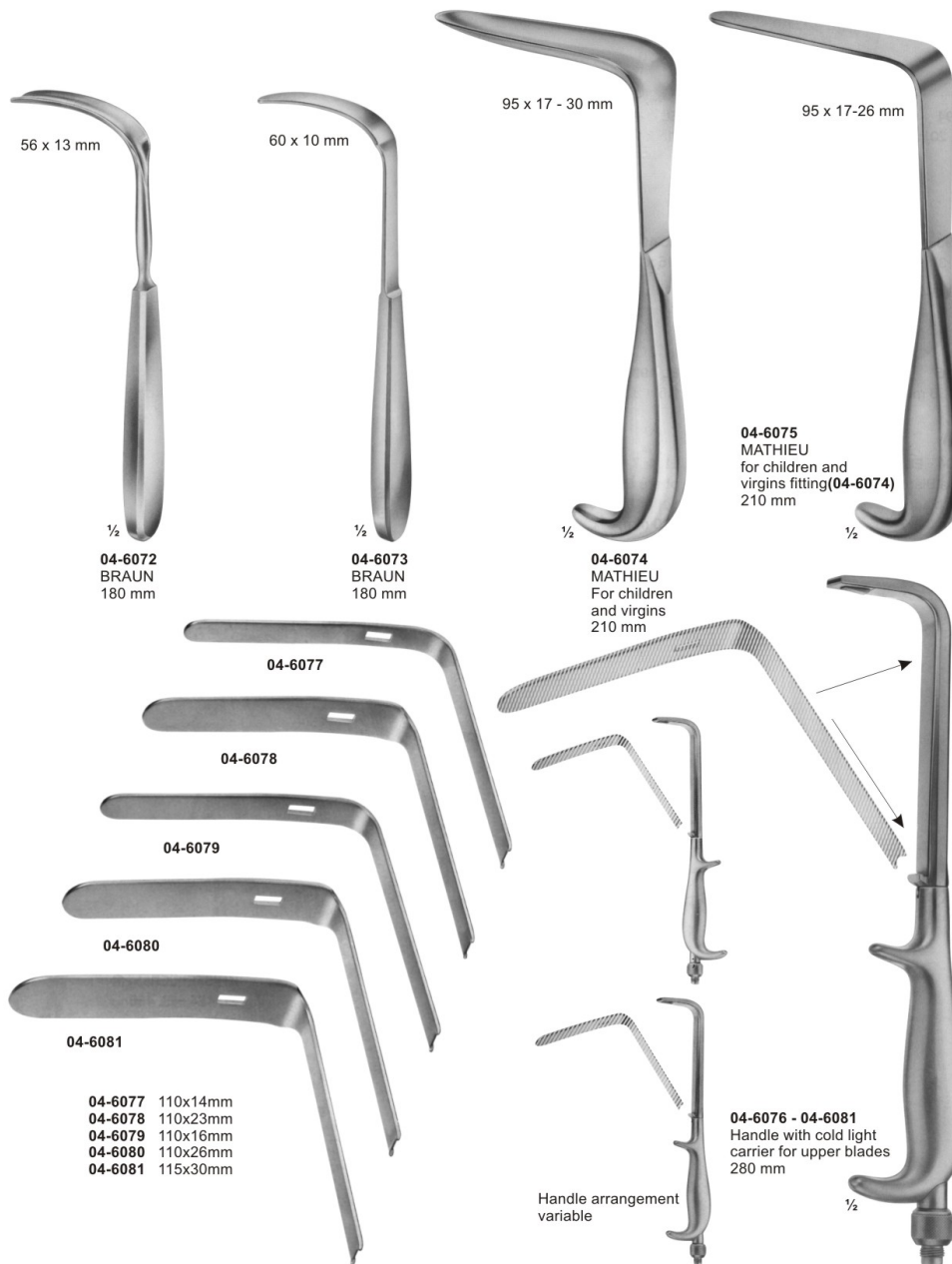

Vaginal Specula-for children and virgins

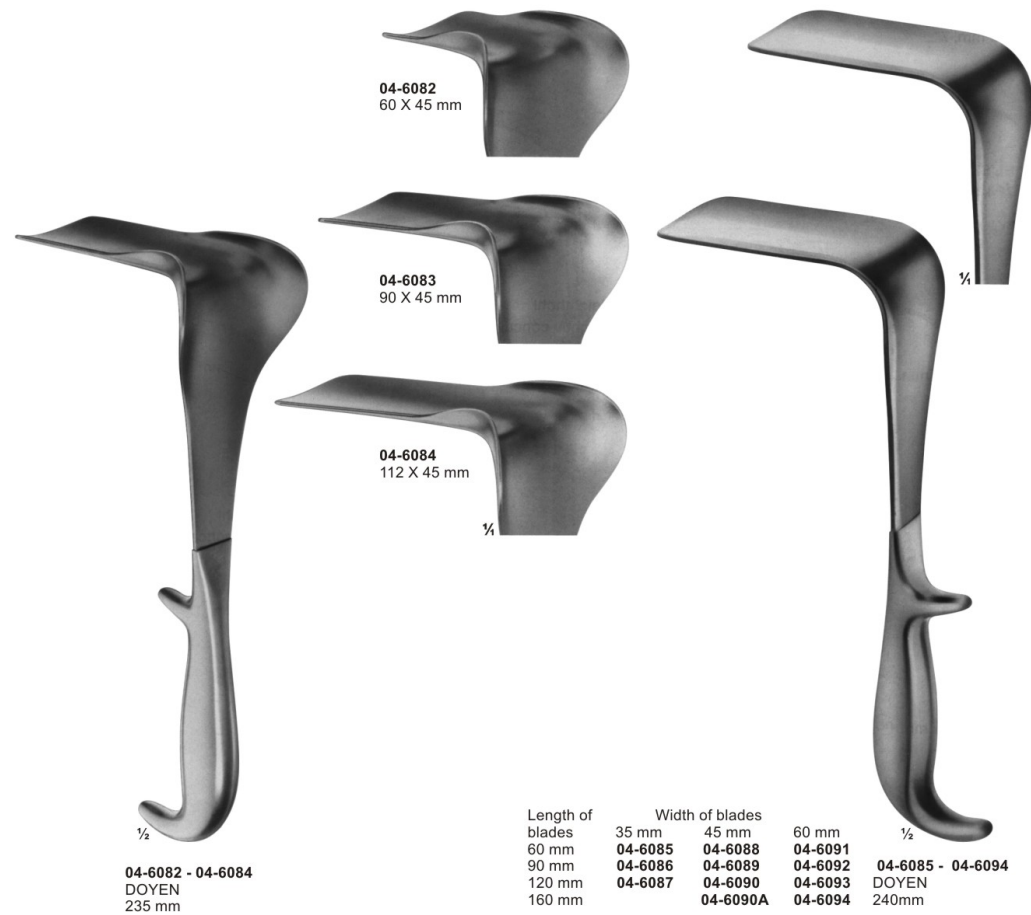

Vaginal Specula / Retractors



04-6095 - 04-6099
BREISKY
WIENER MODELL/
VIENNA PATTERN
04-6095 100 X 20 mm
04-6096 100 X 25 mm
04-6097 100 X 30 mm
04-6098 100 X 35 mm
04-6099 100 X 40 mm
300 mm

04-6100 - 04-6104
BREISKY
WIENER MODELL/
VIENNA PATTERN
04-6100 130 X 20 mm
04-6101 130 X 25 mm
04-6102 130 X 30 mm
04-6103 130 X 35 mm
04-6104 130 X 40 mm
320 mm

04-6107
removable strainer only

04-6105 - 04-6106
WEISSBARTH
04-6105 80 X 28 mm
04-6106 85 X 42 mm
210 mm

04-6108
DOYEN
lateral speculum
80 x 30 mm
250 mm

Vaginal & Wound Retractor / Vaginal Specula



04-6110
115 X 26 mm
275 mm

04-6109 - 04-6110
SIMON
115 X 22 mm
275 mm

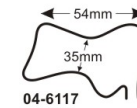
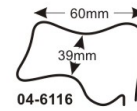
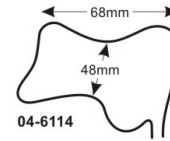

04-6111
AUVARD
65 X 38 mm - 28 mm
1,530 kg = 3 lbs
with fixed weight
230 mm

04-6112 - 04-6113
AUVARD
04-6112 75 X 42-40 mm
04-6113 105 X 43-40 mm
1,470 kg = 3 lbs
with detachable weight
230 mm



04-6114 - 04-6117
MARTIN
with hook shaped
handle for hanging
in weights
270 mm

Vaginal Speculas

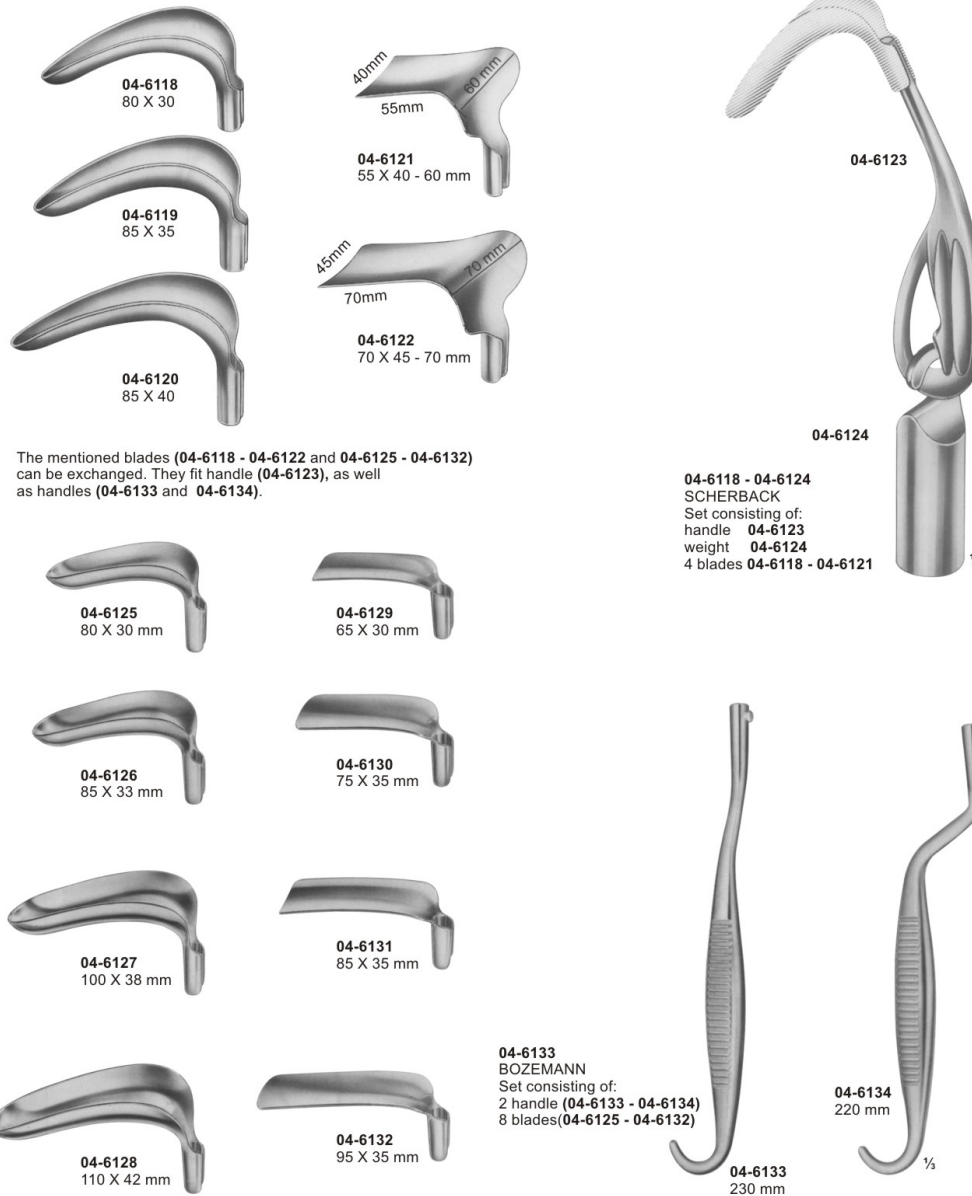

The mentioned blades (**04-6118 - 04-6122** and **04-6125 - 04-6132**) can be exchanged. They fit handle (**04-6123**), as well as handles (**04-6133** and **04-6134**).

Vaginal Retractors



½
04-6135
JOLL (FRIEDMAN)
155 mm



½
04-6136
RICHTER
170 mm



½
04-6137
GELPI
135 mm



½
04-6138
GELPI
175 mm

Uterine Dilators



½

04-6139 - 04-6181
HEGAR
with very conical point
185 mm

04-6139	1	mm	04-6161	23	mm
04-6140	2	mm	04-6162	24	mm
04-6141	3	mm	04-6163	25	mm
04-6142	4	mm	04-6164	26	mm
04-6143	5	mm	04-6165	1	½mm
04-6144	6	mm	04-6166	2	½mm
04-6145	7	mm	04-6167	3	½mm
04-6146	8	mm	04-6168	4	½mm
04-6147	9	mm	04-6169	5	½mm
04-6148	10	mm	04-6170	6	½mm
04-6149	11	mm	04-6171	7	½mm
04-6150	12	mm	04-6172	8	½mm
04-6151	13	mm	04-6173	9	½mm
04-6152	14	mm	04-6174	10	½mm
04-6153	15	mm	04-6175	11	½mm
04-6154	16	mm	04-6176	12	½mm
04-6155	17	mm	04-6177	13	½mm
04-6156	18	mm	04-6178	14	½mm
04-6157	19	mm	04-6179	15	½mm
04-6158	20	mm	04-6180	16	½mm
04-6159	21	mm	04-6181	17	½mm
04-6160	22	mm			



½

04-6182 - 04-6190
HEGAR
205 mm

04-6182	1+2	mm
04-6183	3+4	mm
04-6184	5+6	mm
04-6185	7+8	mm
04-6186	9+10	mm
04-6187	11+12	mm
04-6188	13+14	mm
04-6189	15+16	mm
04-6190	17+18	mm

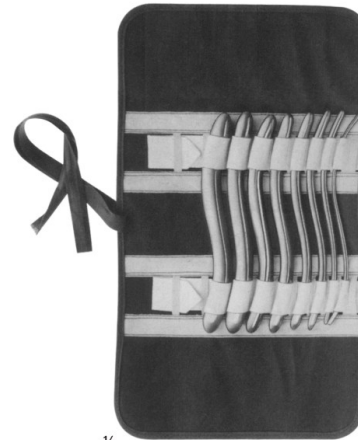

¼

04-6191
HEGAR
Uterine dilator set, in canvas roll
with 8 dilators.

Uterine Dilators - Complete Sets



04-6192
HEGAR
Dilator set consisting of:
14 Dilators,
(04-6193)1 Rack for dilators (4 - 12 mm)
(04-6194)1 Rack for Dilators (13 - 17 mm)
(04-6195)1 Metal case only,
with hinged lid, stainless 200 X 100 X 35 mm



04-6196
HEGAR
Dilator set consisting of:
26 Dilators,
(04-6197)1 Rack for dilators (1 - 17 mm)
(04-6198)1 Rack for Dilators (18 - 26 mm)
(04-6199)1 Metal case only,
with hinged lid, of aluminium 330 X 220 X 80 mm

Endospecula For Cervix

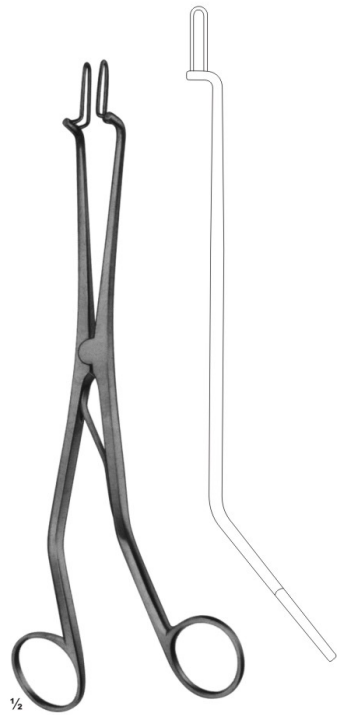

04-6200
KOGAN
Endospecula for cervix
and urethra, without ratchet
240 mm



04-6201
KOGAN
Endospecula for cervix
and urethra, with
scale-ratchet and fixing screws
240 mm

Uterine Probes

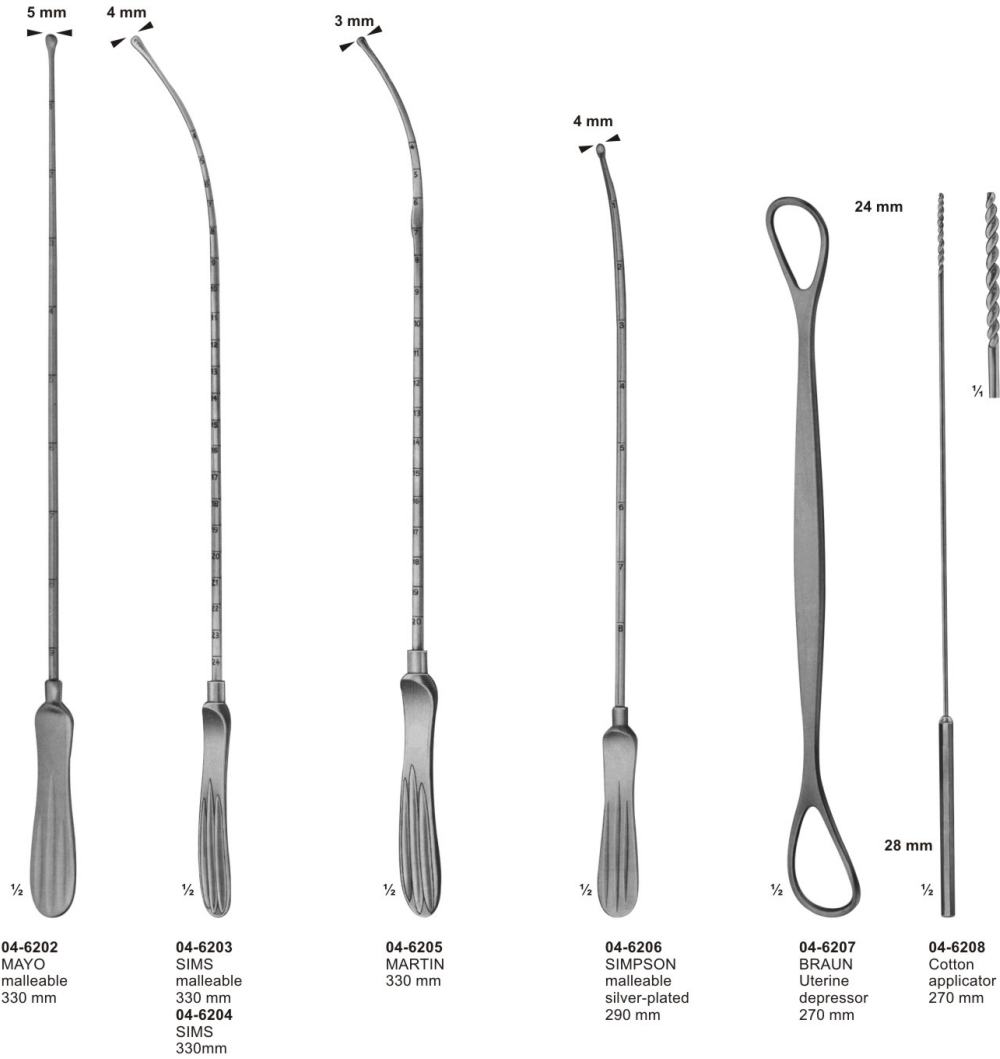

Uterine Dressing Forceps



Jaws with longitudinal groove

Uterine Dressing Forceps

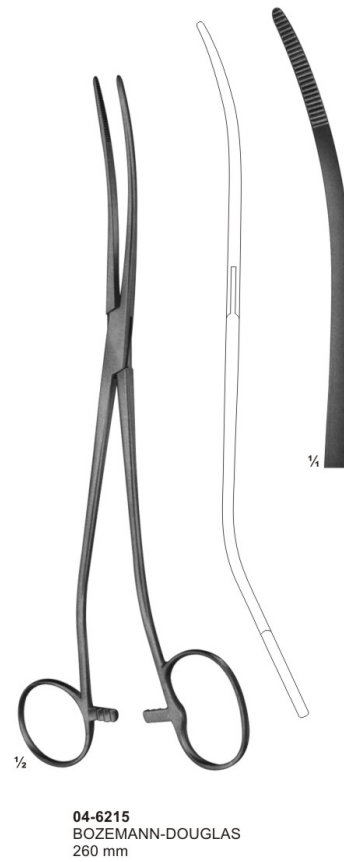
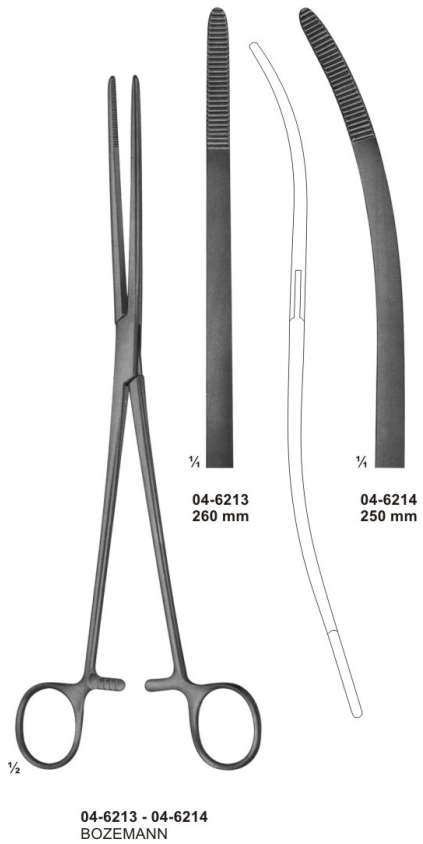

Uterine Tenaculum Forceps

Standard



04-6216
BRAUN
slender type
250 mm



04-6217
SCHROEDER
250 mm



04-6218
POZZI
heavy type
255 mm

Uterine Tenaculum Forceps

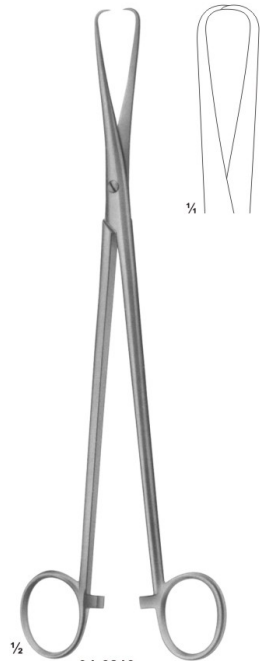

**04-6219
MARTIN**
265 mm

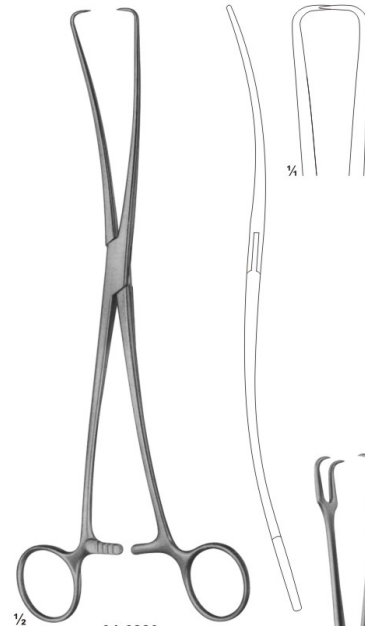

**04-6220
DUPLAY**
250 mm

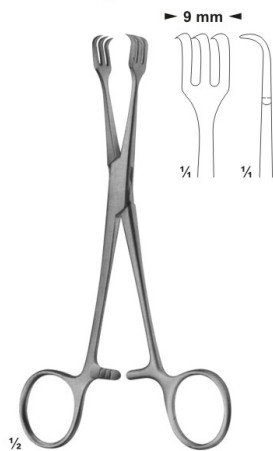
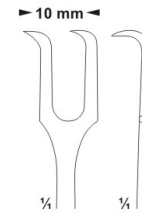

**04-6221
LAHEY**
155 mm

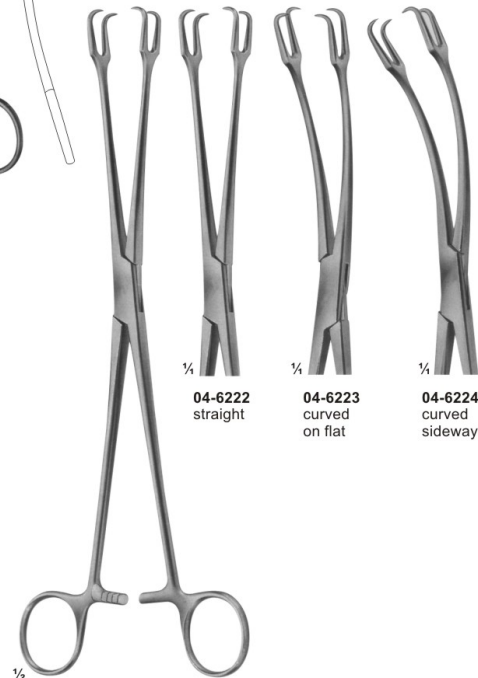

04-6222
straight

04-6223
curved
on flat

04-6224
curved
sideways

Uterine Tenaculum Forceps

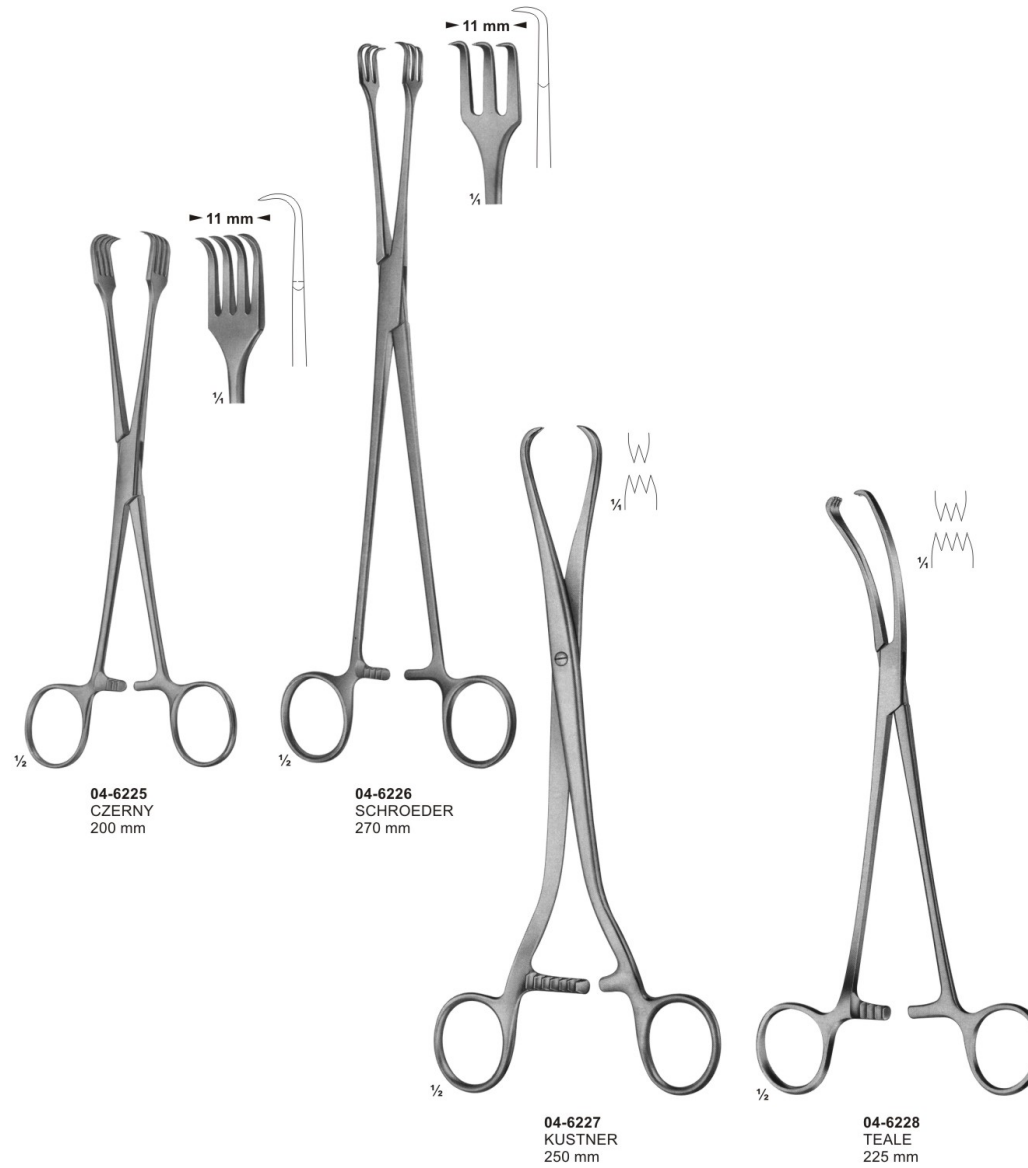

Uterine Tenaculum Forceps



04-6229
JACOBS
215 mm

1/2



04-6230
LITTLEWOOD
185 mm

1/2



04-6231
MUSEUX
200 mm

1/2

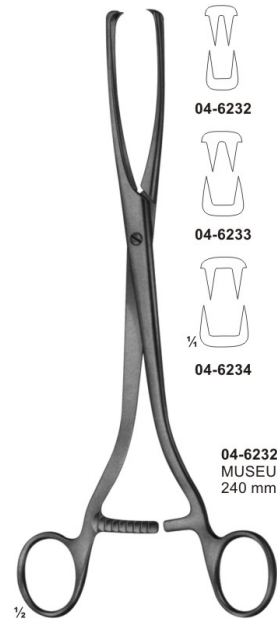

04-6232



04-6233



04-6234

04-6232 - 04-6234
MUSEUX
240 mm

1/2

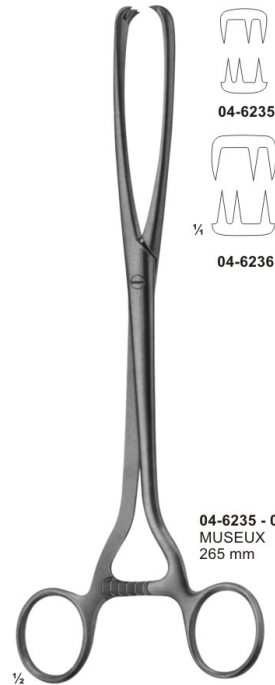

04-6235



04-6236

1/2

04-6235 - 04-6236
MUSEUX
265 mm

1/2

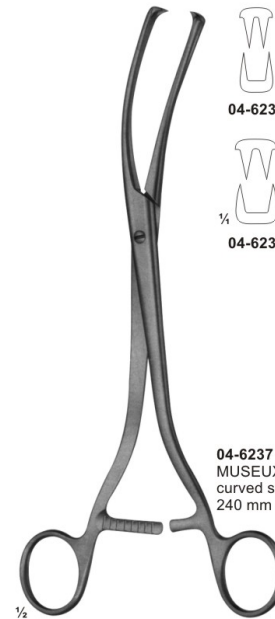

04-6237



04-6238

1/2

04-6237 - 04-6238
MUSEUX
curved sideways
240 mm

1/2

Polypus-and Ovum Forceps

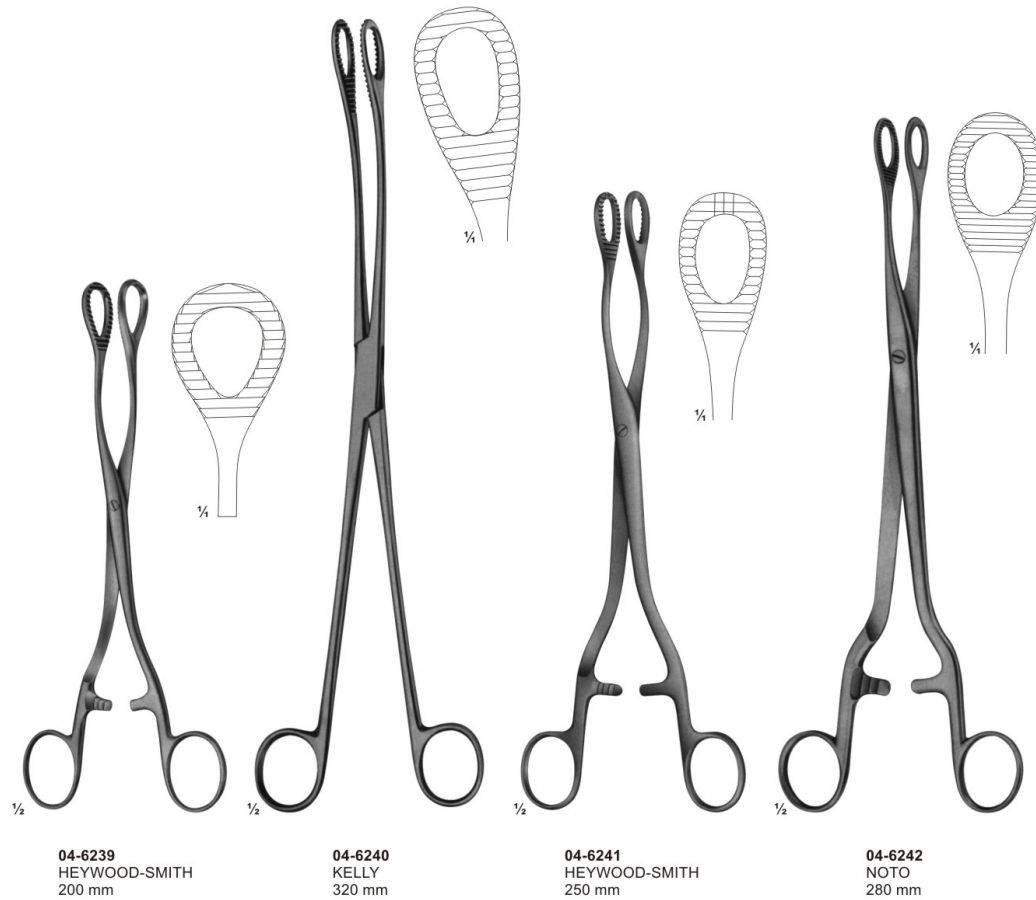

Polypus and Ovum Forceps

Atraumata



04-6244
250mm

04-6245
270mm

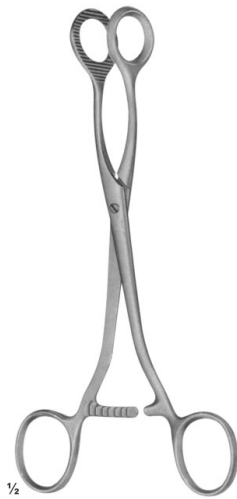

04-6243
DOYEN
185 mm



04-6244 - 04-6245



04-6246
BUMM
280 mm

Uterine Elevating Forceps

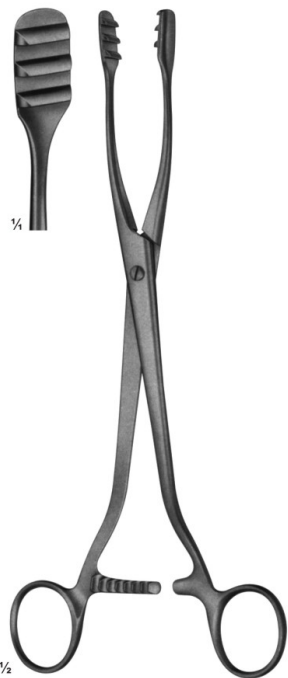

04-6247
COLLIN
250 mm



04-6248
COLLIN
285 mm



04-6249
DARTIGUES
255 mm

Uterine Elevating Forceps



04-6250
SOMMER
235 mm



04-6251
STRASSMANN
265 mm

Uterine Elevating Forceps



04-6252
COLLIN
265 mm

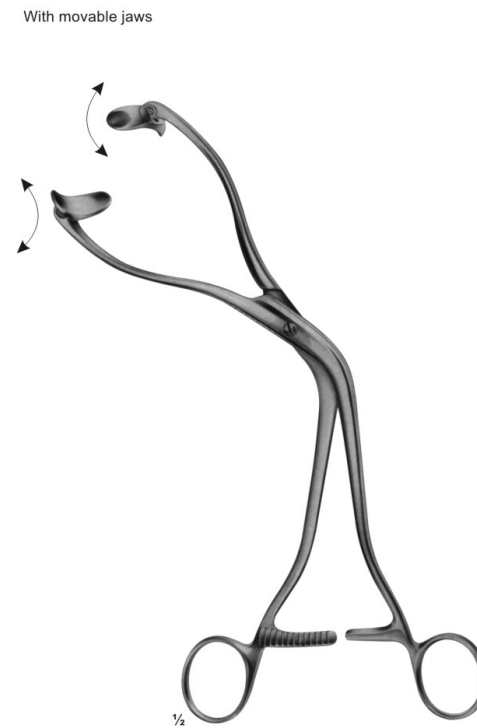

04-6253
APPREX
approx. 260 mm

**Myoma Instruments, Instruments For Micro
Tubal Operations**



04-6254
SEGOND
Myomatome
270 mm



04-6255
DOYEN
Myoma screw
150 mm



04-6256
DOYEN
Myoma screw
190 mm

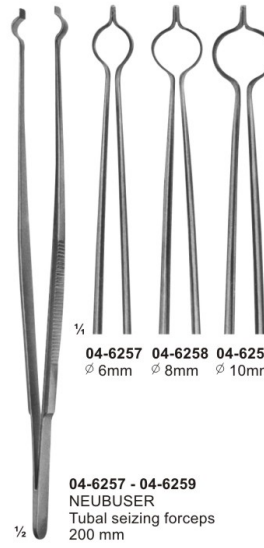

04-6257 04-6258 04-6259
∅ 6mm ∅ 8mm ∅ 10mm

04-6257 - 04-6259
NEUBUSER
Tubal seizing forceps
200 mm

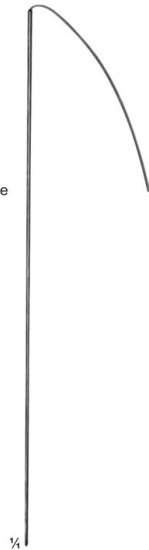

04-6260
Splint guide
with thread



04-6261
Splint guide with
round handle
180 mm



04-6262
Angled glass rods
Set . 3 pieces

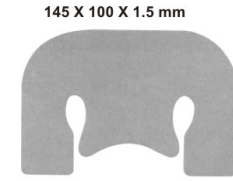

04-6263
Silicon operating pad
pre-cut

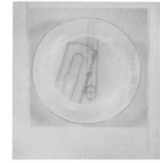

04-6264
Polyaethylen splint material
soft-sterile
0.45 mm

Biopsy Currettes

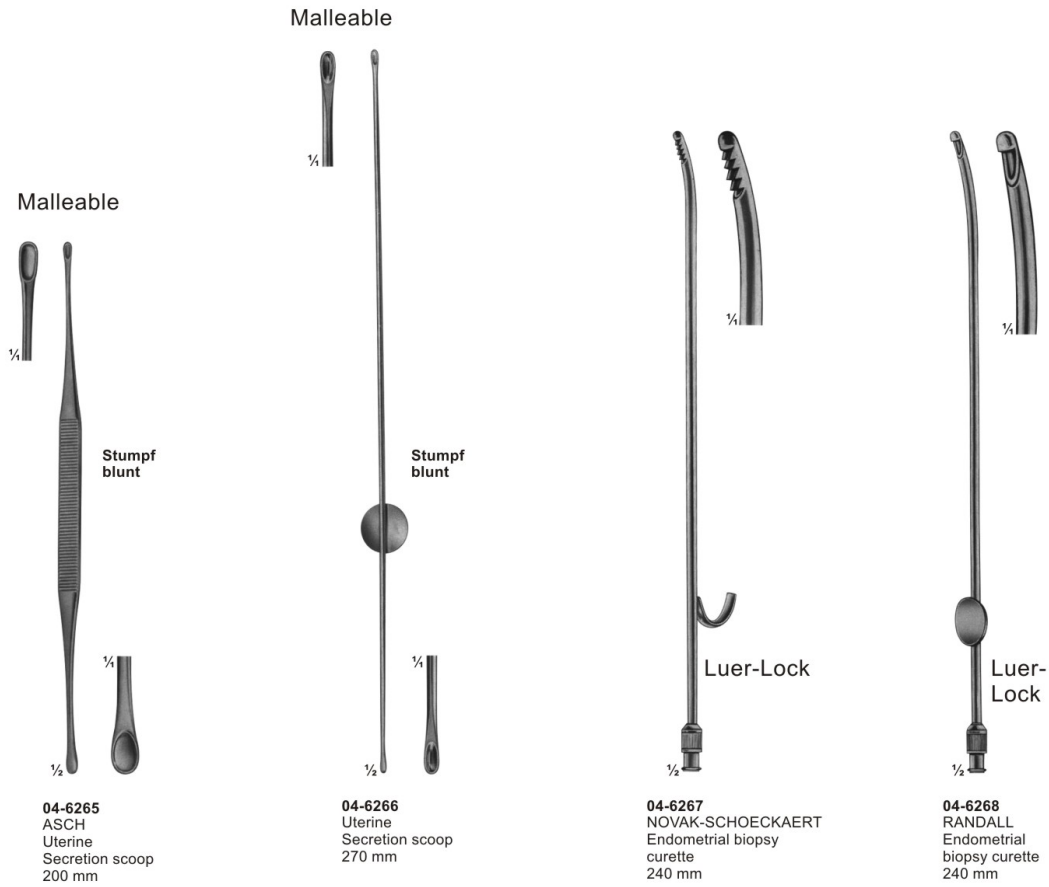

Biopsy Forceps

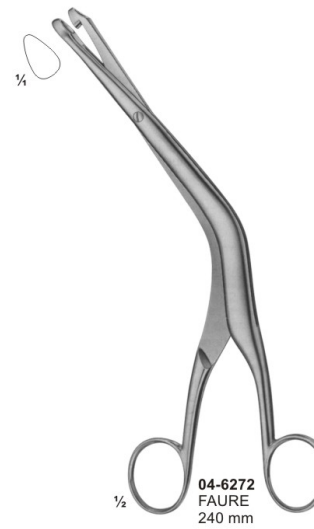
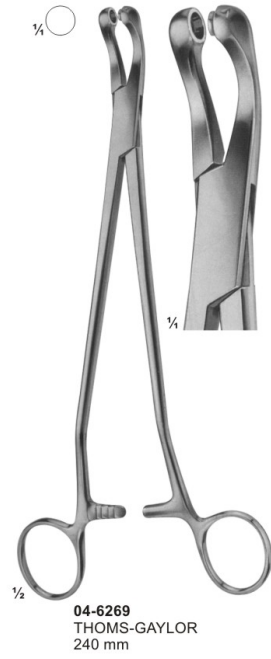

Biopsy Forceps

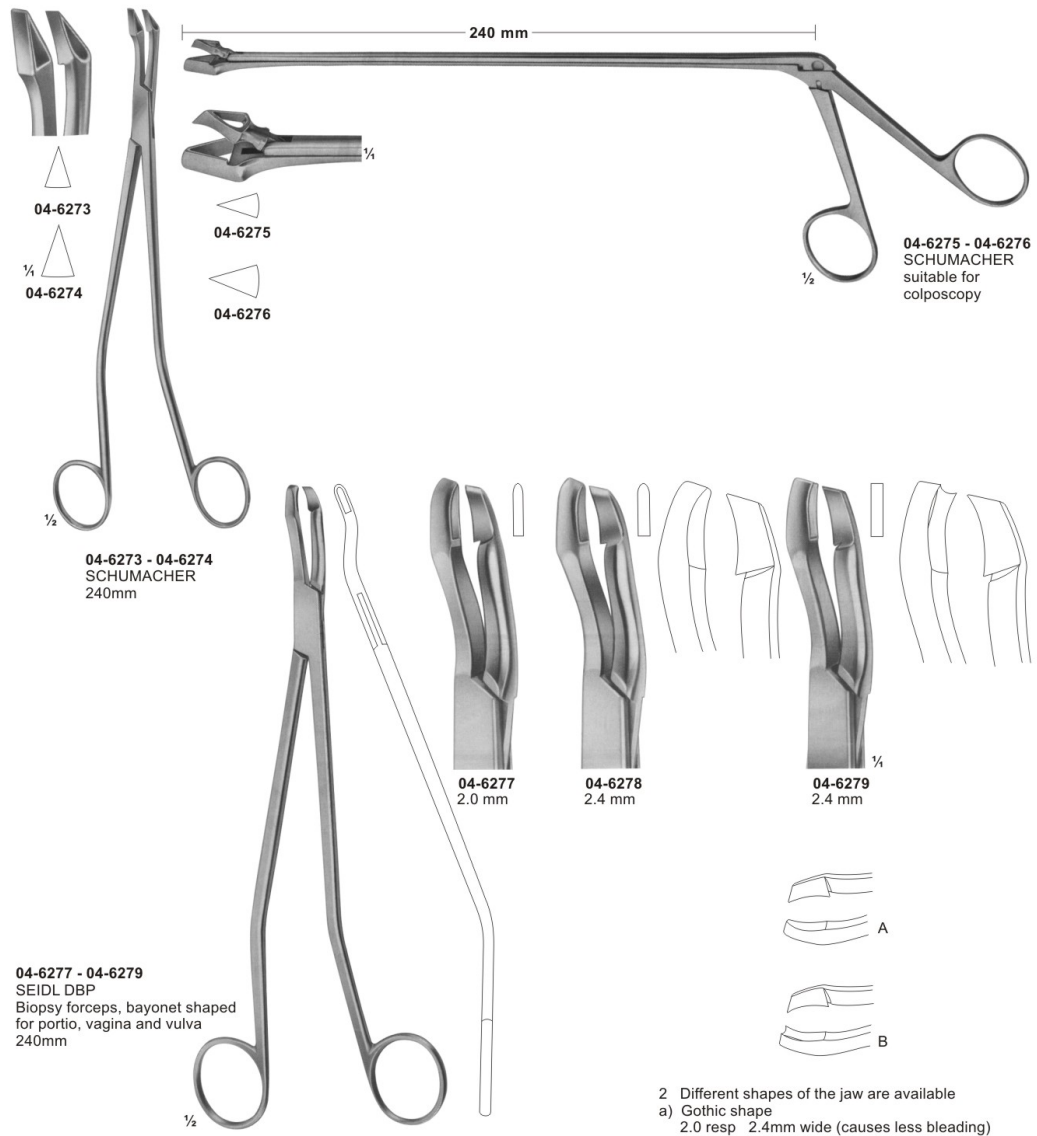

2 Different shapes of the jaw are available
 a) Gothic shape
 2.0 resp. 2.4mm wide (causes less bleeding)
 b) Rectangular shape, 2.4mm wide

Biopsy Forceps

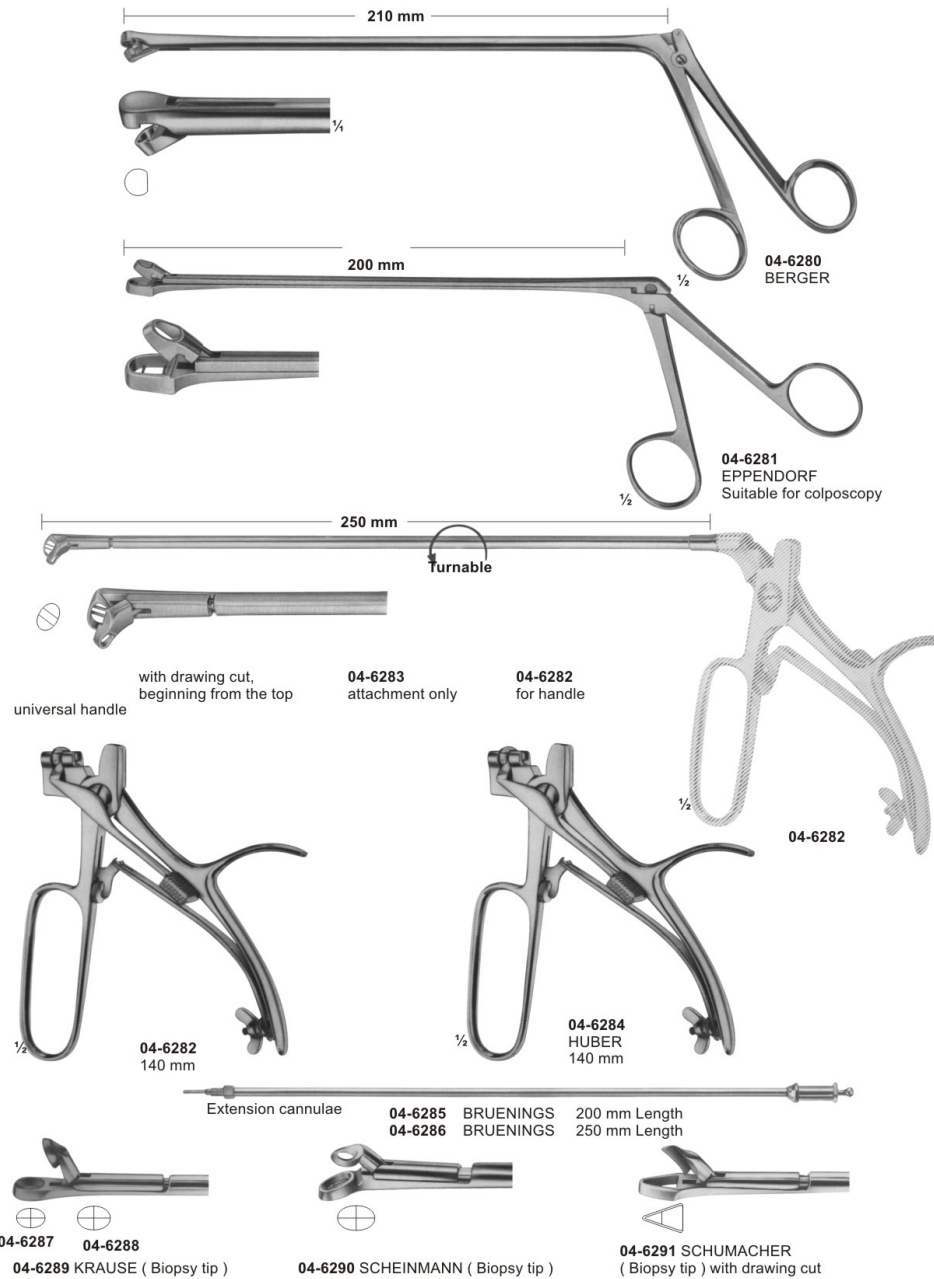

Uterine Scoops

Table of Recamier		Sharp		Blunt
Fig	Width	Rigid	Malleable	Rigid
00	4.5mm	04-6294		
0	7.5mm	04-6295		04-6306
1	8.5mm	04-6296	04-6317	04-6307
2	10.5mm	04-6297	04-6318	04-6308
3	12.0mm	04-6298	04-6319	04-6309
4	14.0mm	04-6299	04-6320	04-6310
5	15.0mm	04-6300	04-6321	04-6311
6	16.5mm	04-6301	04-6322	04-6312
7	18.0mm	04-6302	04-6323	04-6313
8	19.5mm	04-6303	04-6324	04-6314
9	21.5mm	04-6304		04-6315
10	23.5mm	04-6305		04-6316
04-6294 - 04-6305		Sharp - Rigid		
04-6317 - 04-6324		Sharp - Malleable		
04-6306 - 04-6316		Blunt - Rigid		

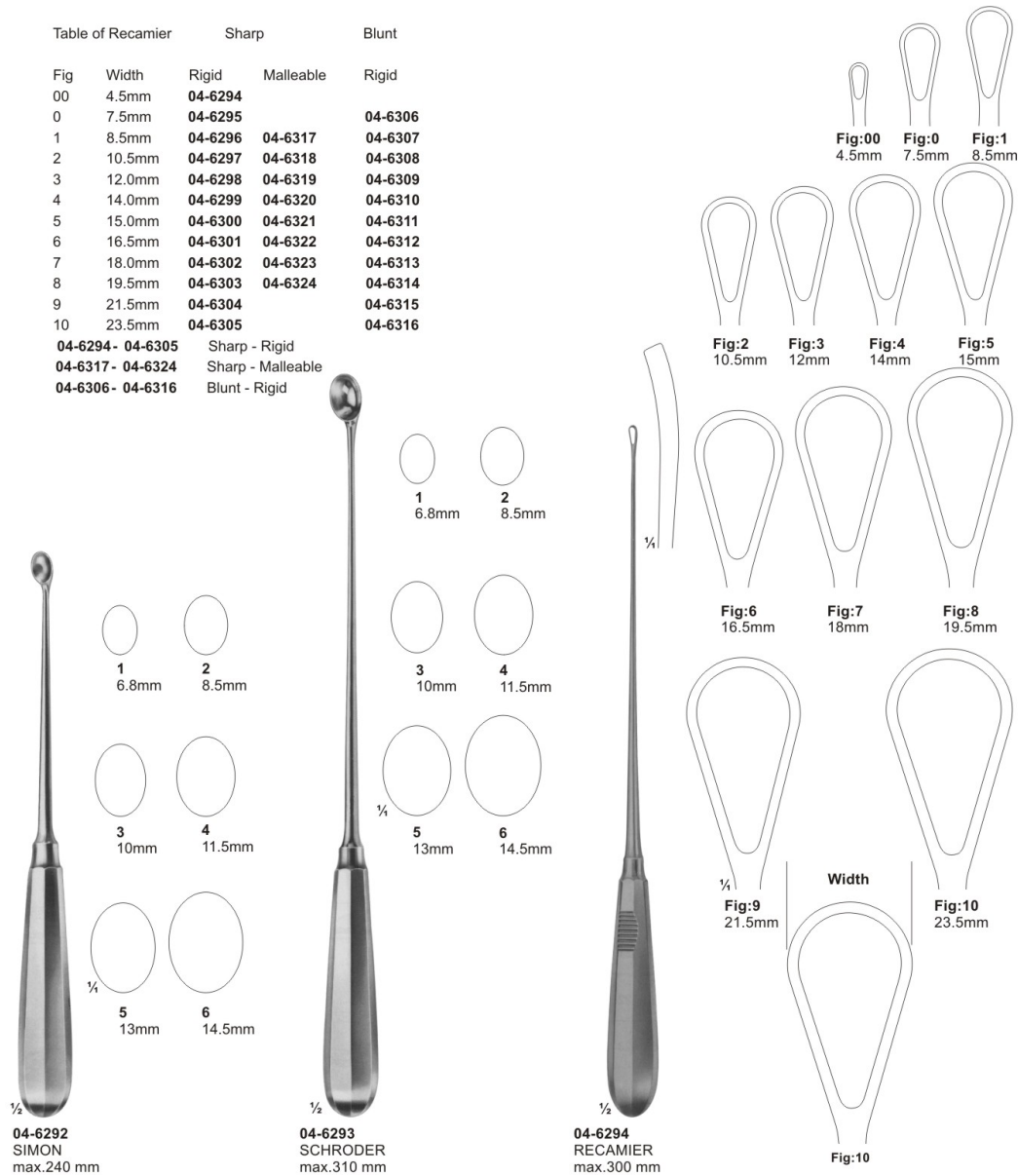

Uterine Curettes

Fig	Width	Sharp		Blunt	
		Rigid	Malleable	Rigid	
1	7.5mm	04-6325	04-6331	04-6337	
2	8.5mm	04-6326	04-6332	04-6338	
3	10.5mm	04-6327	04-6333	04-6339	
4	12.0mm	04-6328	04-6334	04-6340	
5	14.0mm	04-6329	04-6335	04-6341	
6	15.0mm	04-6330	04-6336	04-6342	

04-6325 - 04-6330 Sharp - Rigid
 04-6331 - 04-6336 Sharp - Malleable
 04-6337 - 04-6342 Blunt - Rigid

Fig	Width	Blunt - Malleable
0	16.5mm	04-6343
1	18.5mm	04-6344
2	19.5mm	04-6345
3	21.5mm	04-6346
4	23.5mm	04-6347
5	26.0mm	04-6348
6	28.5mm	04-6349

BUMM

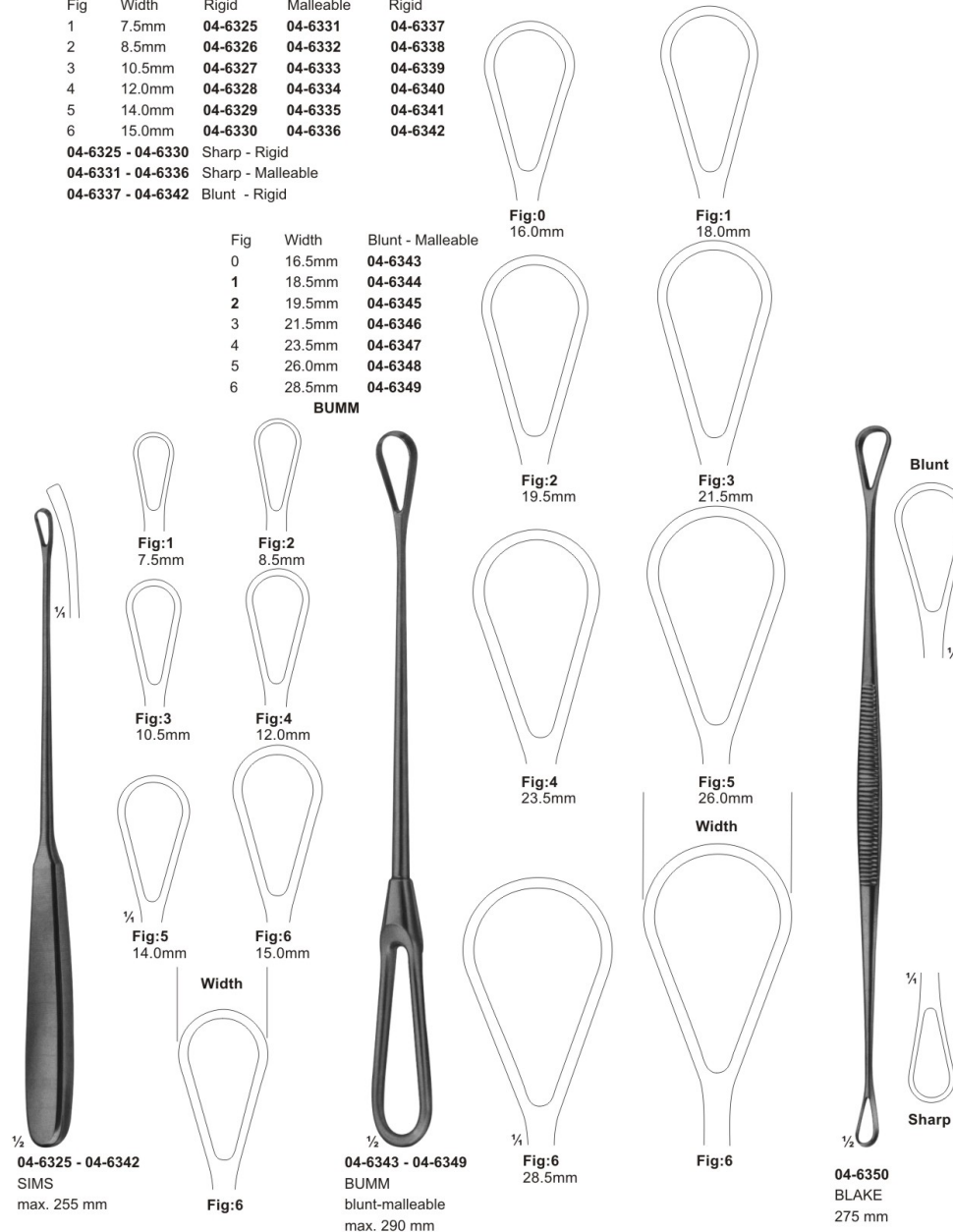

Placenta-and Ovum Curettes

Fig	Width	Sharp Malleable	Blunt Malleable
1	23.5mm	04-6354	04-6356
2	26.0mm		04-6357
3	28.5mm	04-6355	04-6358



04-6351
COLLIN
300 mm



04-6352 - 04-6353
RECAMIER
blunt-rigid
max. 360 mm

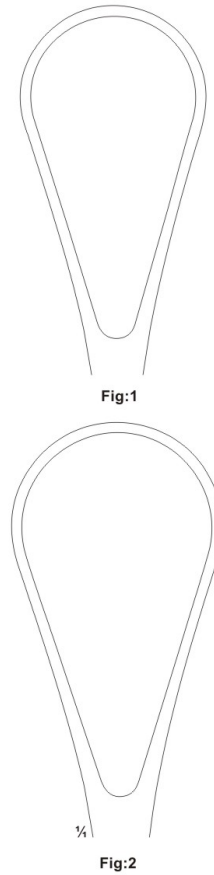

Fig:1

Fig:2



04-6354 - 04-6358
BUMM
max. 310 mm
04-6354 - 04-6355 sharp-malleable
04-6356 - 04-6358 blunt-malleable

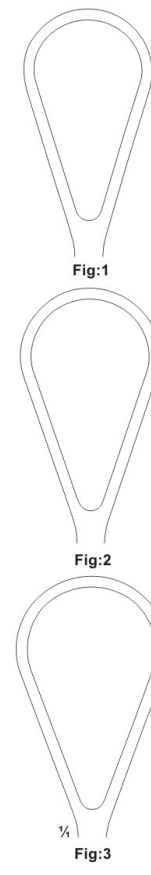

Fig:1

Fig:2

Fig:3

Vacuum Currettes

04-6359 - 04-6364

Suction currettes, stainless steel, fitting hose connection.
Working tips are smoothly rounded off, therefore no danger of perforation.

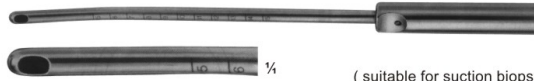

(suitable for suction biopsy)
04-6359: diam 4 mm
04-6360: diam 6 mm
04-6361: diam 8 mm
04-6362: diam 10 mm
04-6363: diam 12 mm
04-6364: diam 14 mm

04-6365

Hose connection inside diam. 11 mm, curved, stainless steel.

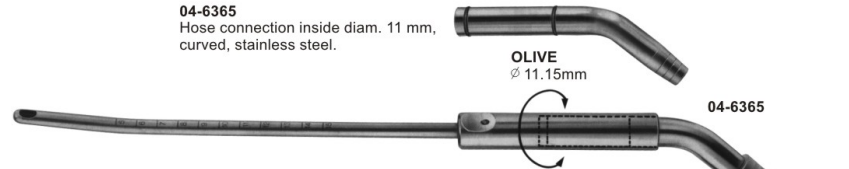

The new connection between suction curette and hose connection, (**04-6365**) Guarantees quick changing and free turning of the suction currettes on the hose connection.

04-6366

Transparent suction hose 1.8 mm long, inside diam 11 mm, outside diam 16.5 mm can be sterilized in an autoclave at 1 bar overpressure (120° C)

04-6367

Strainer for tissues, plastic, for single use only, to be used for histopathological examination.



Gynaecological Instruments



½
04-6368 diam 8 mm
04-6369 diam 10 mm
BOZEMANN-FRITSCH
Uterine Flushing Tube
350 mm



04-6371

04-6372

04-6370
SCHULZE
Salpingograph, for utero-salpingography
in wooden case, consisting of:
04-6371 Manometer only
04-6372 Connection only, without manometer
04-6373 Uterine cannula with tape without cone
04-6374 Cone only, small
04-6375 Cone only, medium
04-6376 Cone only, large
04-6377 Record syringe, 10CC, luer-lock mount.



04-6373



04-6374



04-6375



04-6376

04-6377



04-6378
SCHULZE
Salpingograph, equipment like(04-6370)
but without manometer.



Obstetrics-Pelvimeters

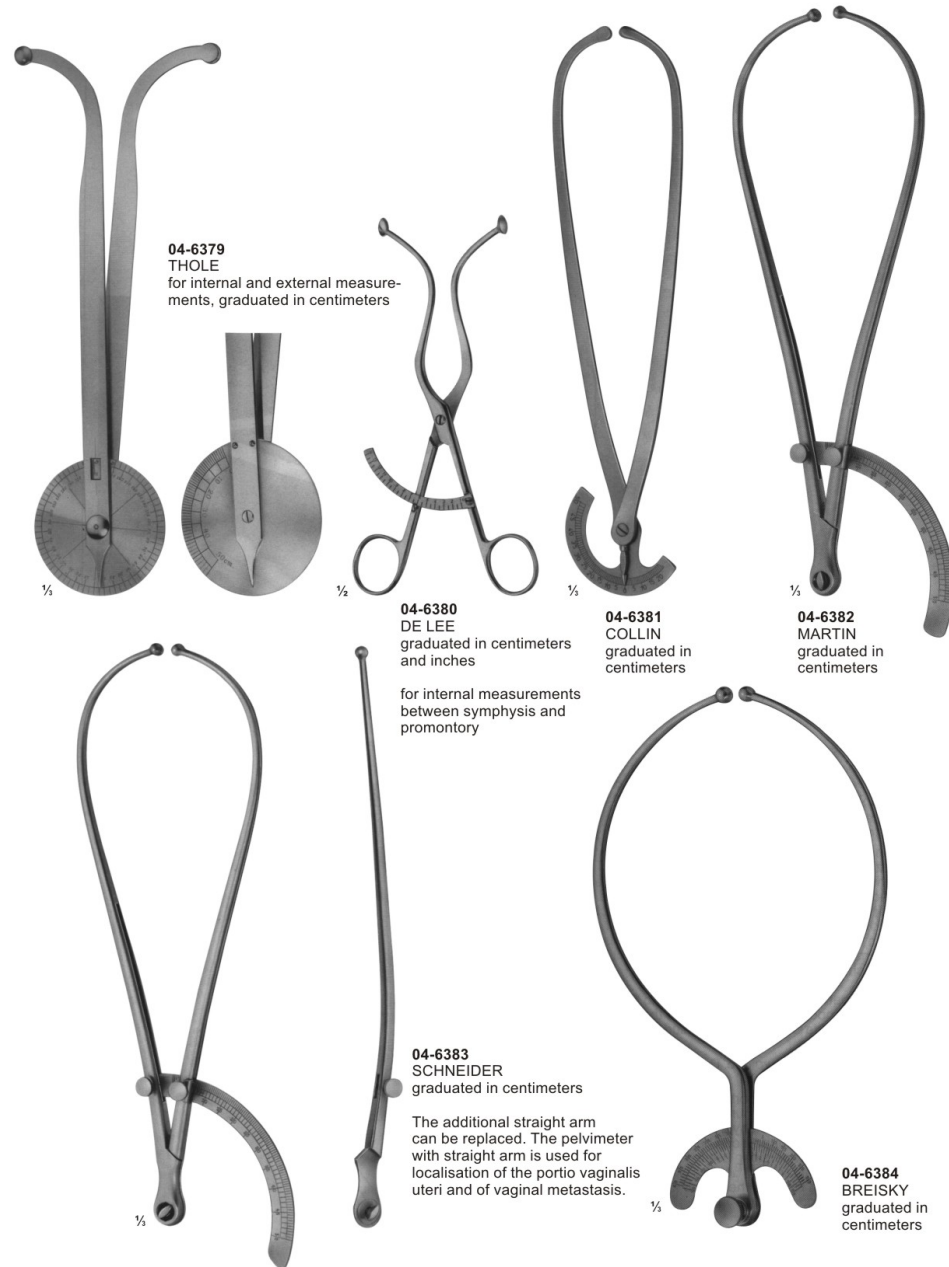

04-6379
THOLE
for internal and external measurements, graduated in centimeters

04-6380
DE LEE
graduated in centimeters and inches

04-6381
COLLIN
graduated in centimeters

04-6382
MARTIN
graduated in centimeters

for internal measurements between symphysis and promontory

04-6383
SCHNEIDER
graduated in centimeters

The additional straight arm can be replaced. The pelvimeter with straight arm is used for localisation of the portio vaginalis uteri and of vaginal metastasis.

04-6384
BREISKY
graduated in centimeters

Forceps For Obstetrics

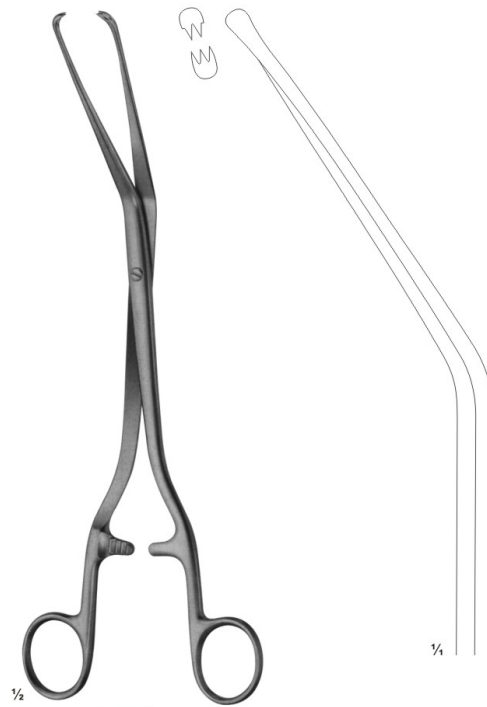

04-6385
HERFF
membrane puncturing
forceps
255 mm



04-6386
IOWA
membrane puncturing
forceps
260 mm

Scissors of Obstetrics, Umbilical cord clamp



04-6387
SCHUMACHER
Umbilical cord
scissors
155 mm



04-6388
Umbilical cord
scissors
105 mm

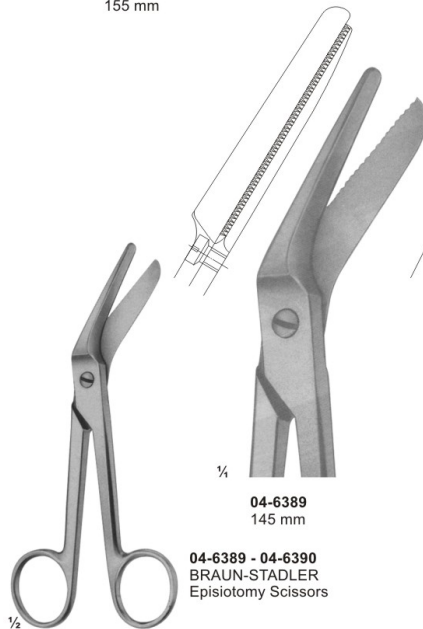

04-6389 - 04-6390
BRAUN-STADLER
Episiotomy Scissors

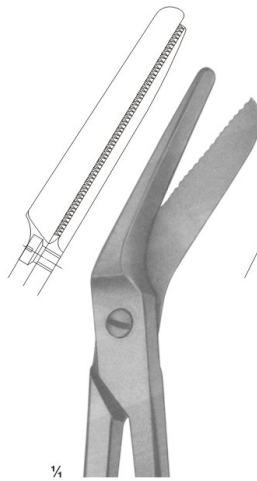

04-6389
145 mm

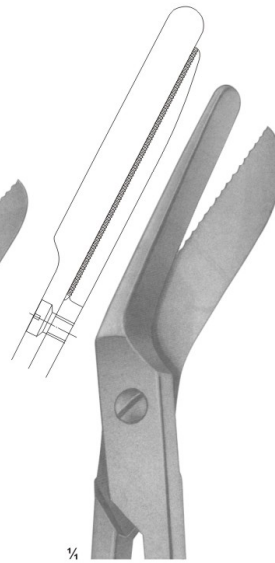

04-6390
200 mm

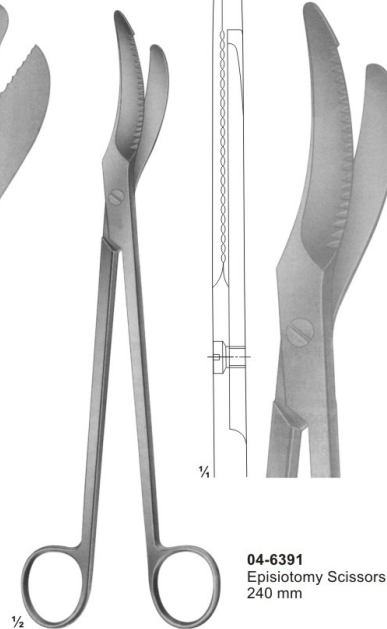

04-6391
Episiotomy Scissors
240 mm

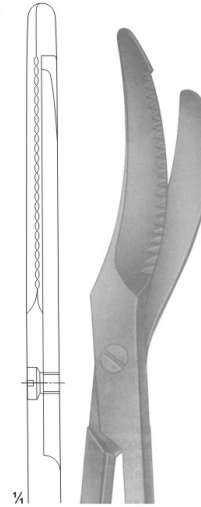

Obstetrics - Obstetrical Forceps

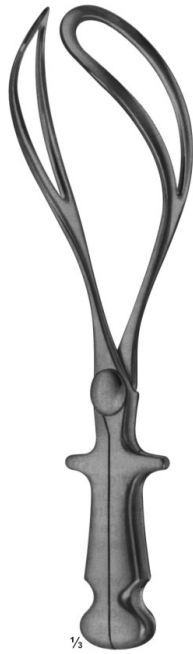

04-6392
NAEGELE
355 mm



04-6393
NAEGELE
400 mm



04-6394
SIMPSON-BRAUN
305mm

Obstetrics - Obstetrical Forceps



1/3

04-6395
SIMPSON-BRAUN
350mm

For caesarean section



1/3

04-6396
SIMPSON
235mm

For caesarean section



1/3

04-6397
WRIGLEY
250 mm

Obstetrics Forceps



Obstetrics-Placenta and Ovum Forceps

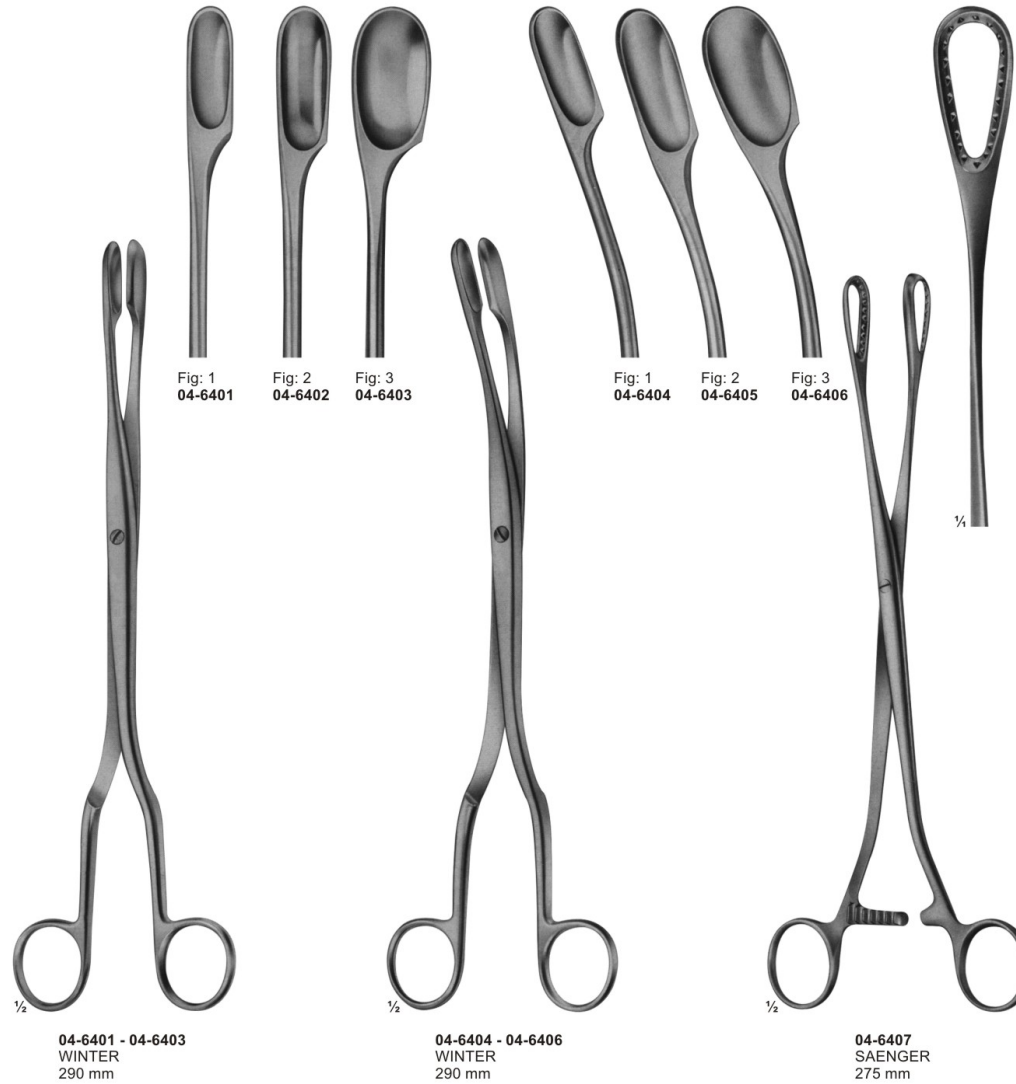

Obstetrics-Placenta and Ovum Forceps

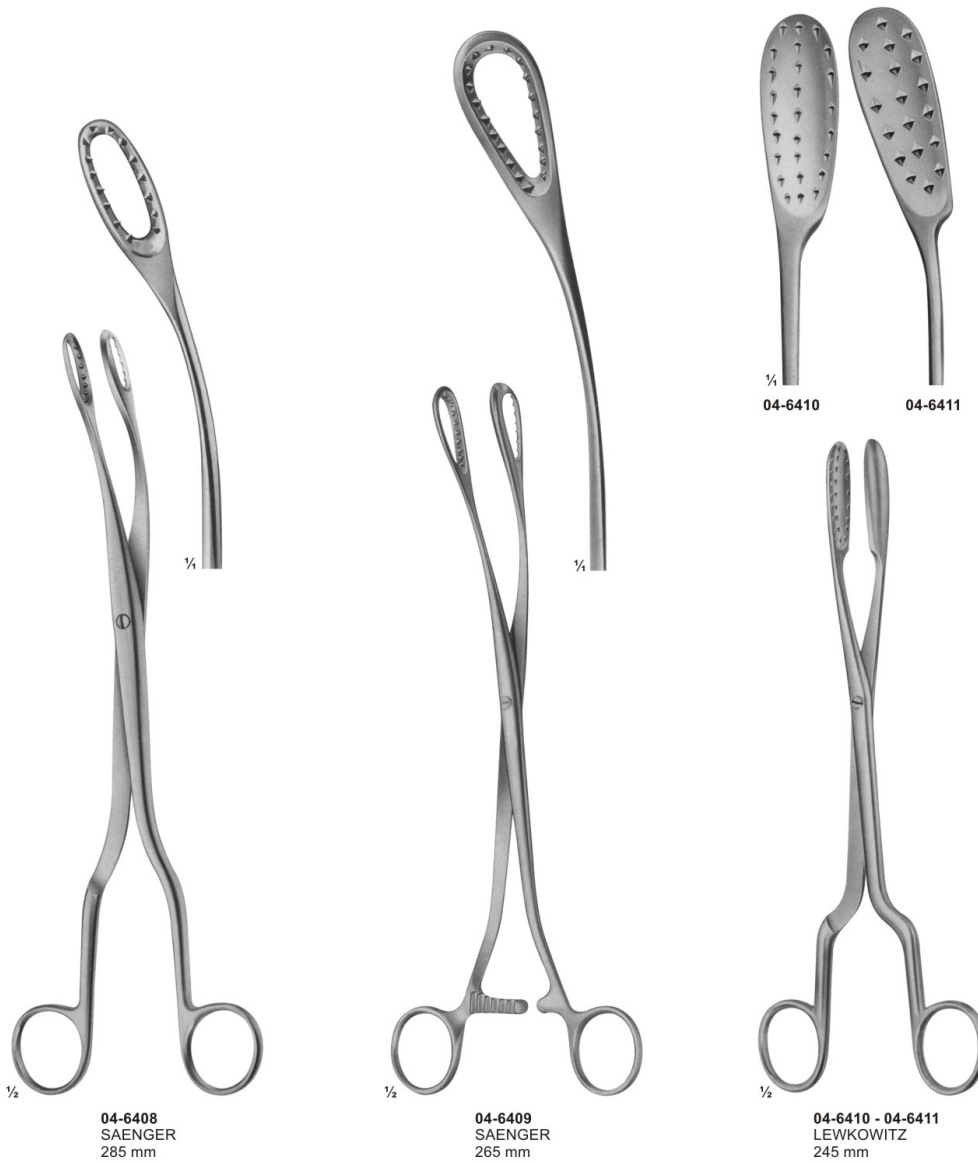

**Obstetrics-Placenta and Ovum Forceps,
Perforator, Cranioclast**

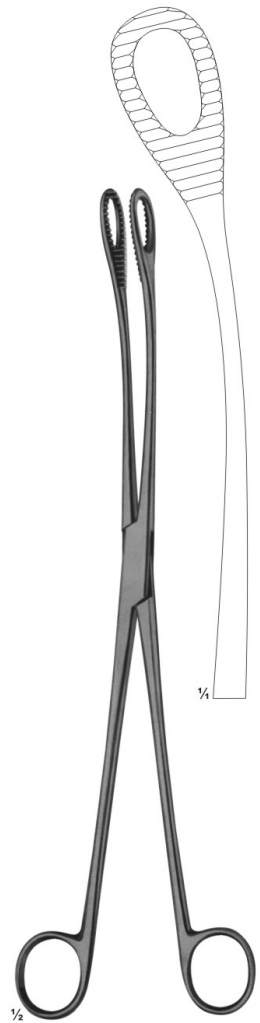

04-6412
KELLY
320mm



04-6413
SMELLIE
Perforator
270mm

1 jaws fenestrated

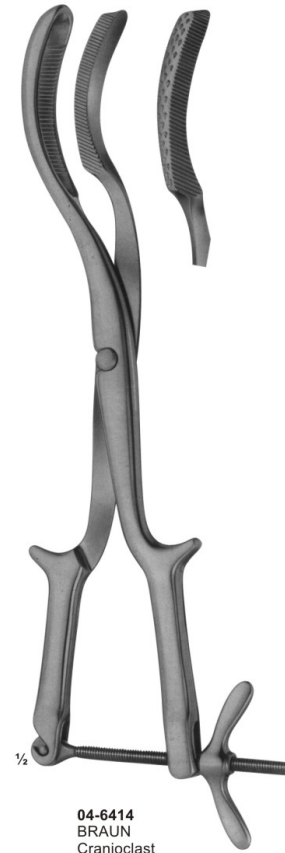

04-6414
BRAUN
Cranioclast
420mm

Tracheal Tubes with inner tubes

Fig.	0	1	2	3	4	5	6	7	8	9	10
∅ mm	4	5	6	7	8	9	10	11	12	13	14
Charr./Fr.	12	15	18	21	24	27	30	33	36	39	42



½

05-7001
UECKERMANN-DENKER
Crycothrotomy trocar
with silver cannula
130mm

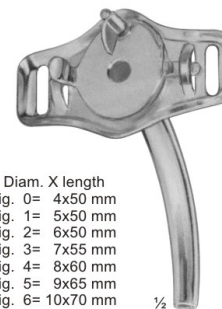

½

Diam. X length
05-7002 Fig. 0= 4x50 mm
05-7003 Fig. 1= 5x50 mm
05-7004 Fig. 2= 6x50 mm
05-7005 Fig. 3= 7x55 mm
05-7006 Fig. 4= 8x60 mm
05-7007 Fig. 5= 9x65 mm
05-7008 Fig. 6= 10x70 mm
05-7009 Fig. 7= 11x80 mm
05-7010 Fig. 8= 12x85 mm
05-7011 Fig. 9= 13x90 mm
05-7012 Fig. 10=14x90 mm
05-7002 - 05-7012
 LUER
 German silver



½

05-7013 - 05-7022
JACKSON
 German Silver
 Diam. X length
05-7013 Fig. 0= 4x50 mm
05-7014 Fig. 1= 5x48 mm
05-7015 Fig. 2= 6x58 mm
05-7016 Fig. 3= 7x70 mm
05-7017 Fig. 4= 8x78 mm
05-7018 Fig. 5= 9x84 mm
05-7019 Fig. 6= 10x84 mm
05-7020 Fig. 7= 11x86 mm
05-7021 Fig. 8= 12x88 mm
05-7022 Fig. 9= 13x90 mm



½

Diam. X length
05-7023 - 05-7032
05-7023 Fig. 1= 5x48 mm JACKSON
05-7024 Fig. 2= 6x58 mm Stainless Steel
05-7025 Fig. 3= 7x70 mm
05-7026 Fig. 4= 8x78 mm
05-7027 Fig. 5= 9x84 mm
05-7028 Fig. 6= 10x84 mm
05-7029 Fig. 7= 11x86 mm
05-7030 Fig. 8= 12x88 mm
05-7031 Fig. 9= 13x90 mm
05-7032 Fig. 10= 14x90 mm

Wound-and Tracheal Hooks and Dilators



05-7033
BOSE
165 mm



05-7034
BOSE
165 mm



05-7035 - 05-7037
180 mm



05-7035
sharp



05-7036
blunt



05-7037
blunt



05-7038
FINSEN
50 mm



05-7039
FINSEN
70 mm



05-7040
TROUSSEAU
120 mm



05-7041
LABORDE
125 mm



05-7042
LABORDE
strong pattern
135 mm



05-7043
Cleaning Brush
for tracheal tubes
285 mm

**Irrigating Cannulae, Embolus Grasping
Forceps, Dilators**

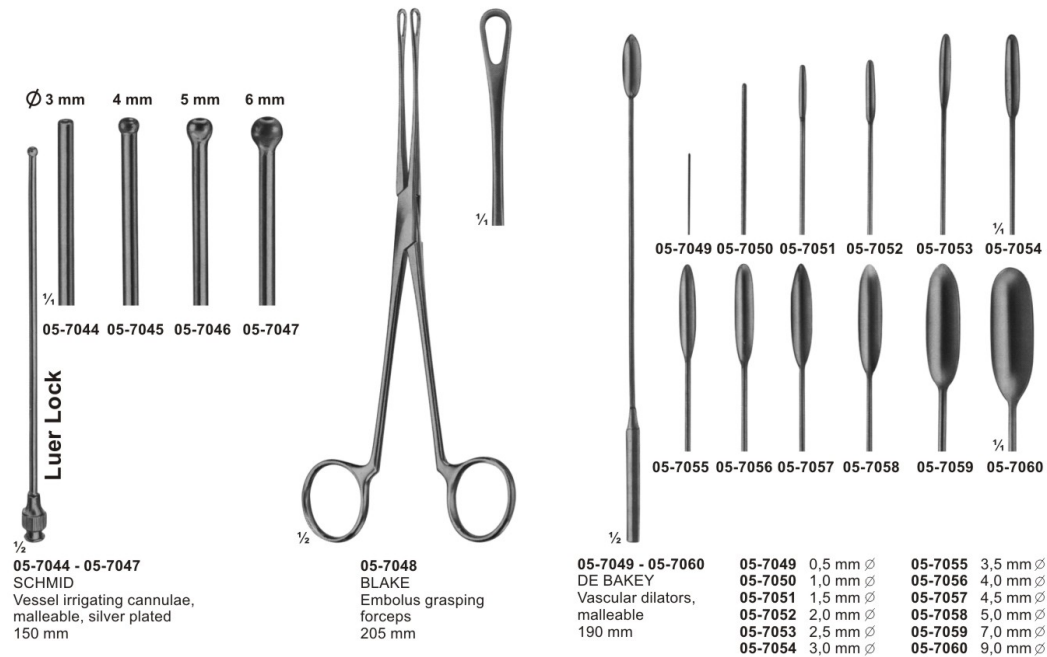

Vascular Spatulas

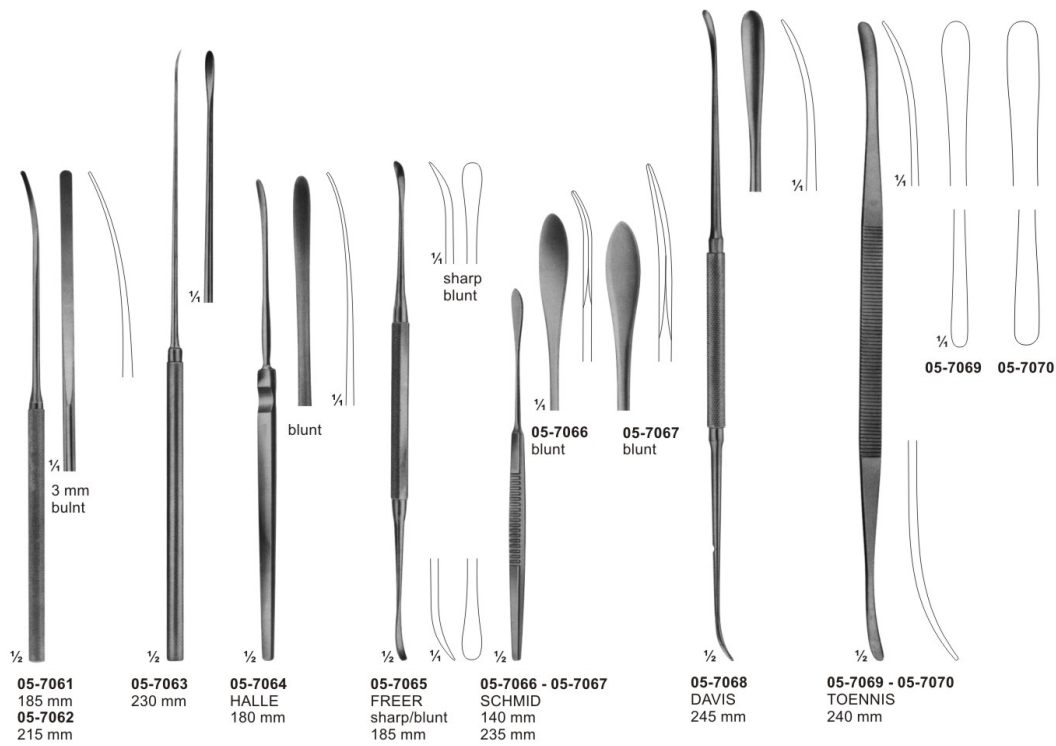

Endarterectomy Strippers, Tourniquets

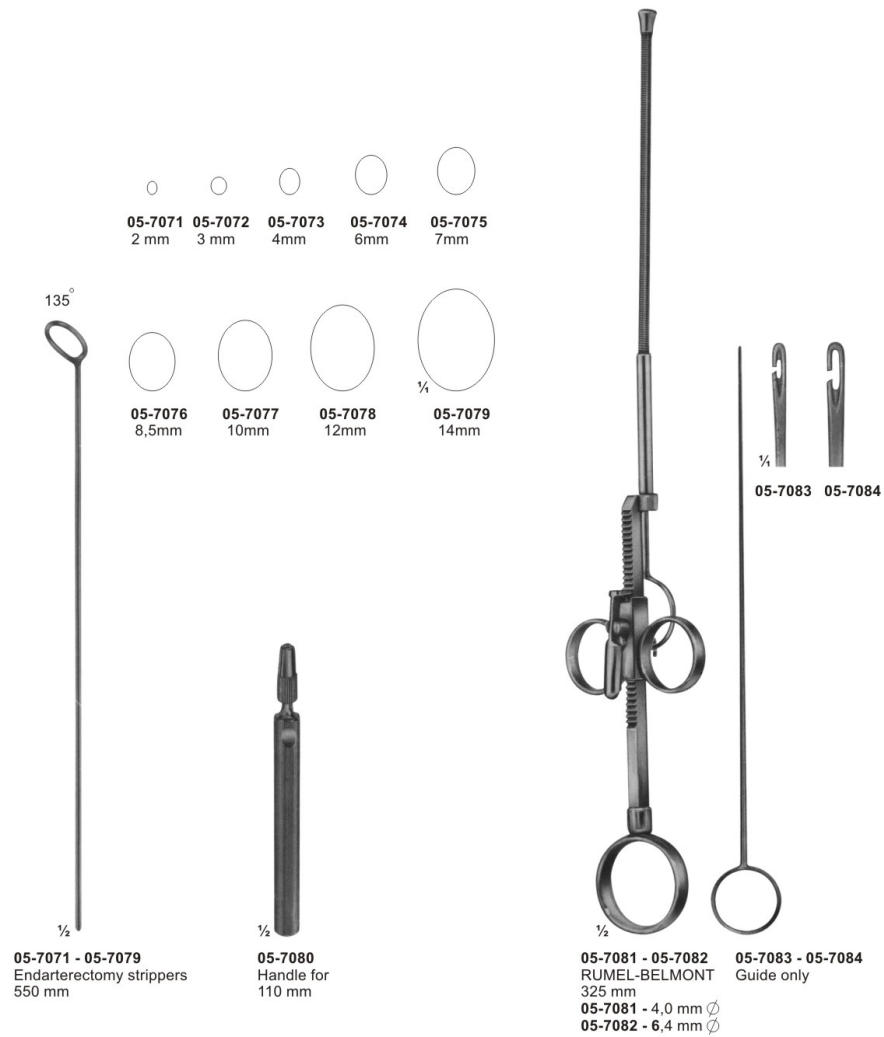

Bioptome and Aortic Dilators

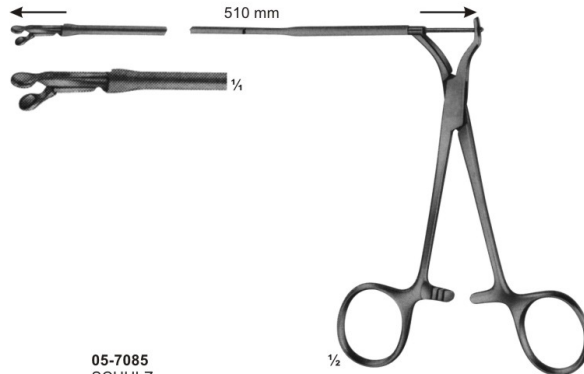

05-7085
SCHULZ
Bioptome, with flexible Shaft, 510 mm long,
with round jaws 3 mm diam.

Biopsy forceps, for biopsy from the right atrium
through cava jugularis, prior to heart implantations.

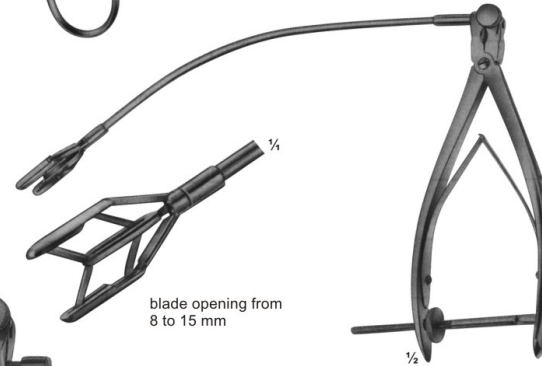

05-7087
COOLEY
Dilator for
mitral valve
for children

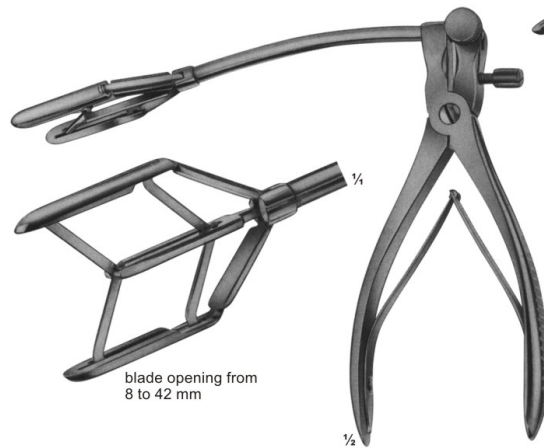

05-7086
TUBBS
Dilator for
mitral valve

blade opening from
8 to 15 mm

blade opening from
8 to 42 mm

JENKER Instrument Set For Tunnelling And Pulling-Through Vascular Grafts Toothings

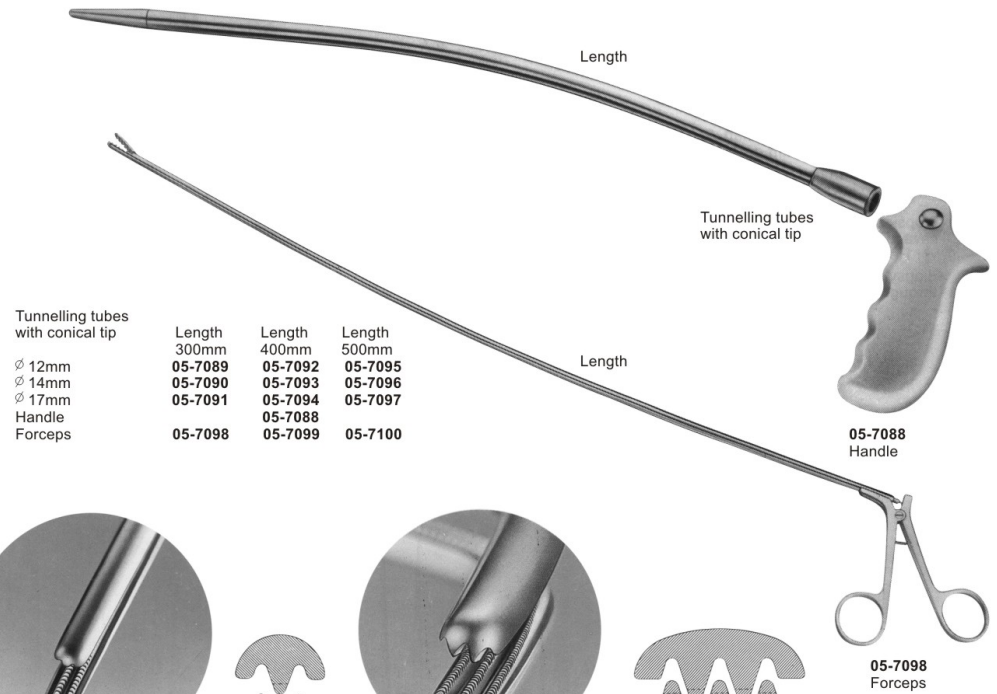

Tunnelling tubes with conical tip	Length 300mm	Length 400mm	Length 500mm
∅ 12mm	05-7089	05-7092	05-7095
∅ 14mm	05-7090	05-7093	05-7096
∅ 17mm	05-7091	05-7094	05-7097
Handle	05-7088	05-7088	05-7088
Forceps	05-7098	05-7099	05-7100

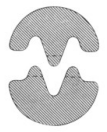
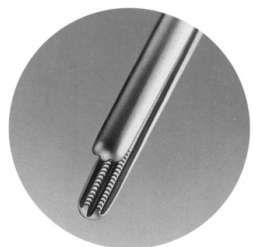

DE BAKEY
05-7101
1 : 2 rows of teeth

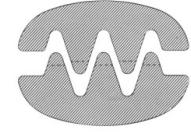
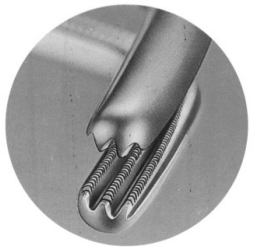

DE BAKEY
05-7102
2 : 3 rows of teeth

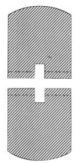
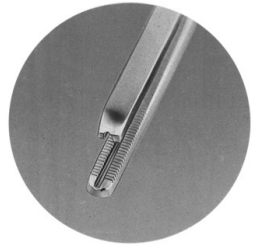

COOLEY
05-7103
2 : 2 rows of teeth

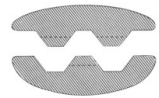
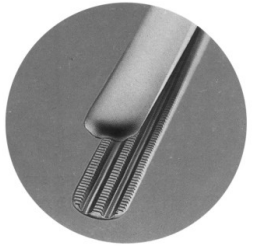

DARDIK
05-7104
2 : 3 rows of teeth



05-7088
Handle

05-7098
Forceps

Atraumata Ultra-Light-Forceps

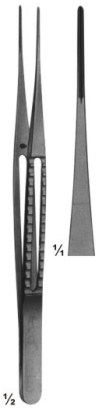

05-7105
Width of jaws 1.2 mm
Length 150mm

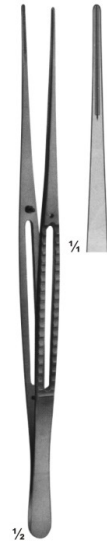

05-7106
Width 1,5 mm
Lenght 200 mm



05-7107
Width 1,5 mm
Length 240 mm



05-7108
Width 1,5 mm
Lenght 300 mm

Atraumata Dissecting Forceps



Atraumata Ring Handle Bulldog Clamps

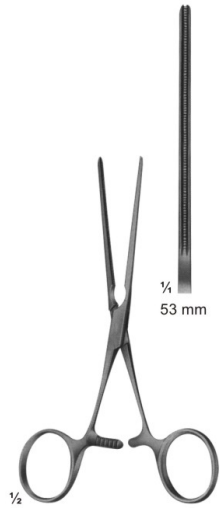

05-7124
DE-BAKEY
straight
130 mm

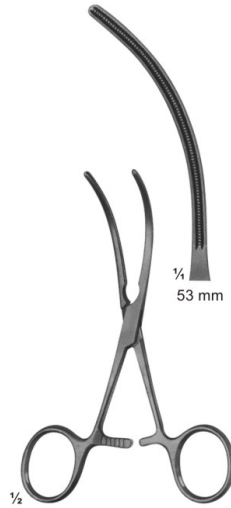

05-7125
DE-BAKEY
curved jaws
125 mm

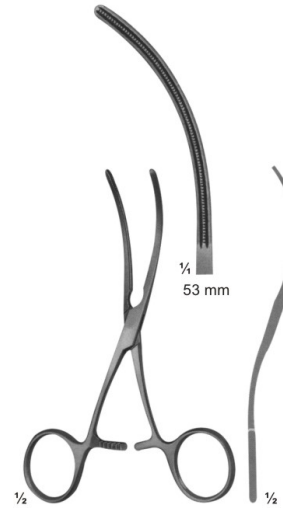

05-7126
DE-BAKEY
S-shaped curved
125 mm

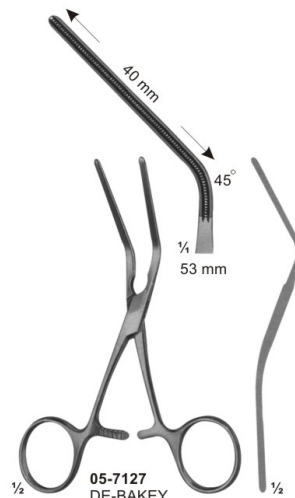

05-7127
DE-BAKEY
angled 45
125 mm



05-7128
DE-BAKEY
angled 90
105 mm

Atraumata Anastomosis and Multi-Purpose-Clamps for Neonatales

graduated



½
05-7129 - 05-7132
CASTANEDA

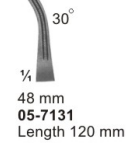
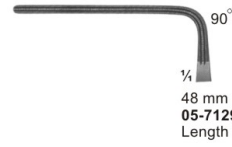

graduated



½
05-7133 - 05-7136
CASTANEDA

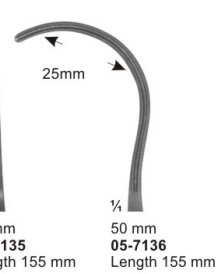
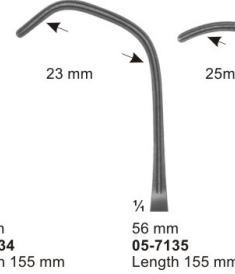
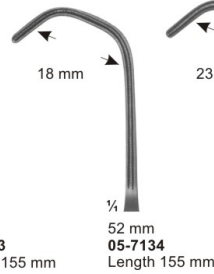
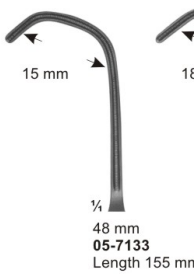

**Atraumata Anastomosis-and Multi-Purpose
Clamps-Pediatric types**

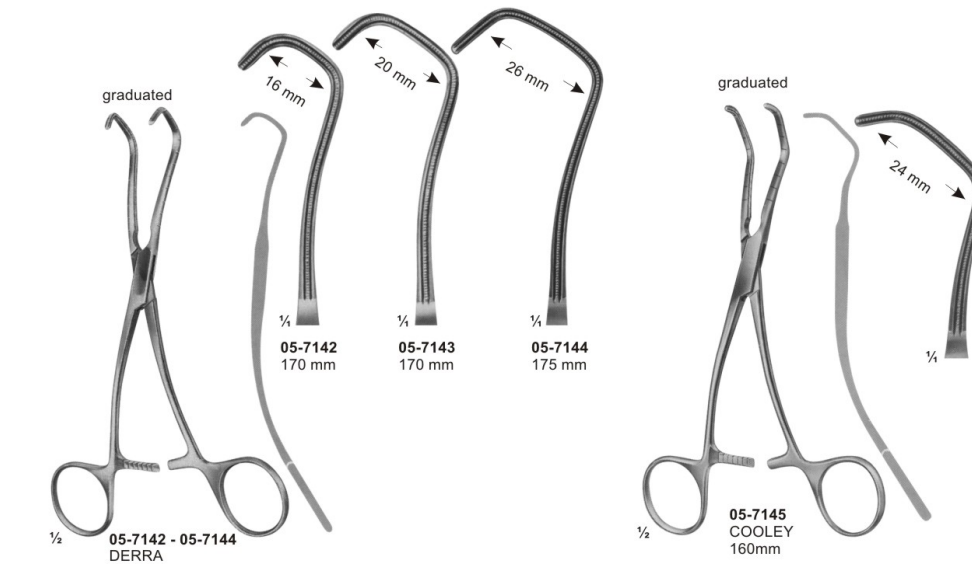
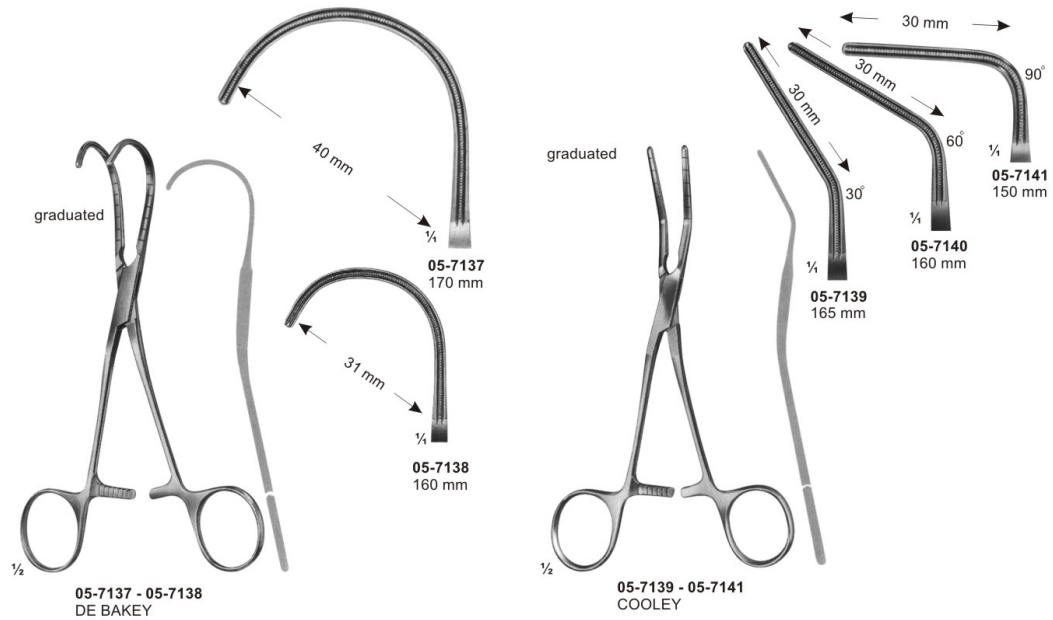

**Atraumata Non-traumatic
Haemostatic Forceps**

Mosquito Forceps

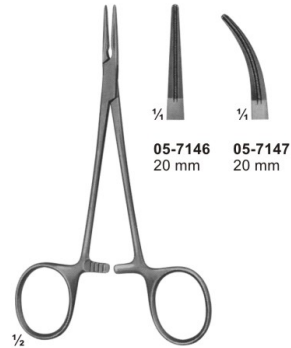

05-7146
20 mm

05-7147
20 mm

05-7146 - 05-7147
125 mm



05-7148
27 mm

05-7149
27 mm

05-7148 - 05-7149
165 mm

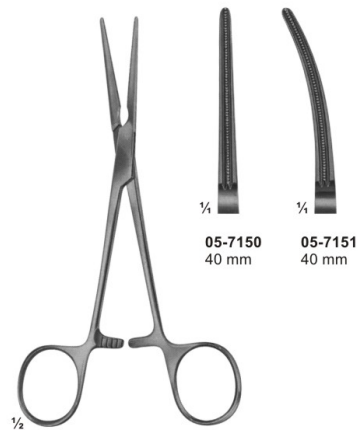

05-7150
40 mm

05-7151
40 mm

05-7150 - 05-7151
DE BAKEY-BAINBRIDGE
155 mm



05-7152
65 mm

05-7153
65 mm

05-7152 - 05-7153
DE BAKEY-BAINBRIDGE
180 mm

Atraumata Non-traumatic Haemostatic Forcep



05-7154 - 05-7155
DE-BAKEY-KELLY
140 mm



05-7156 - 05-7157
PEAN
155 mm

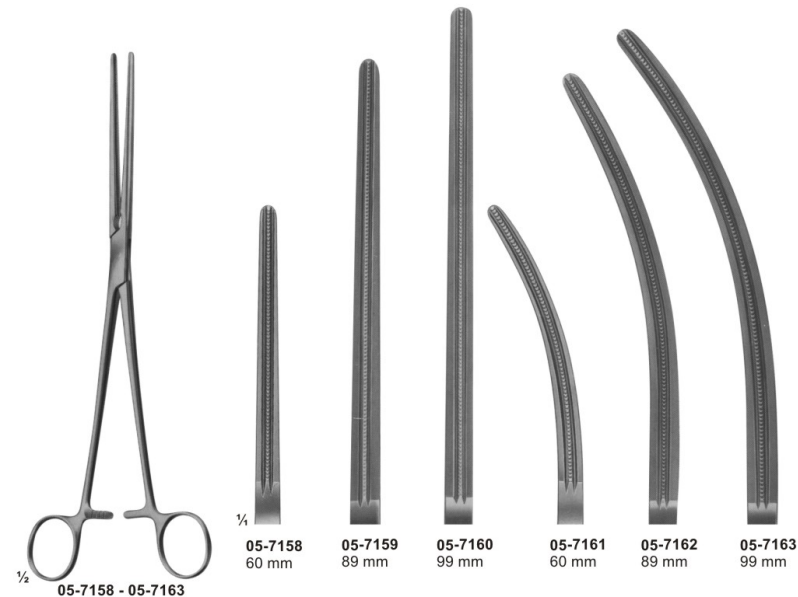

05-7158 - 05-7163
DE-BAKEY-PEAN DE-BAKEY-PEAN
05-7158 200 mm 05-7161 200 mm
05-7159 265 mm 05-7162 260 mm
05-7160 280 mm 05-7163 275 mm

**Atraumata Dissecting And Ligature
Forceps Anastomosis Clamps**

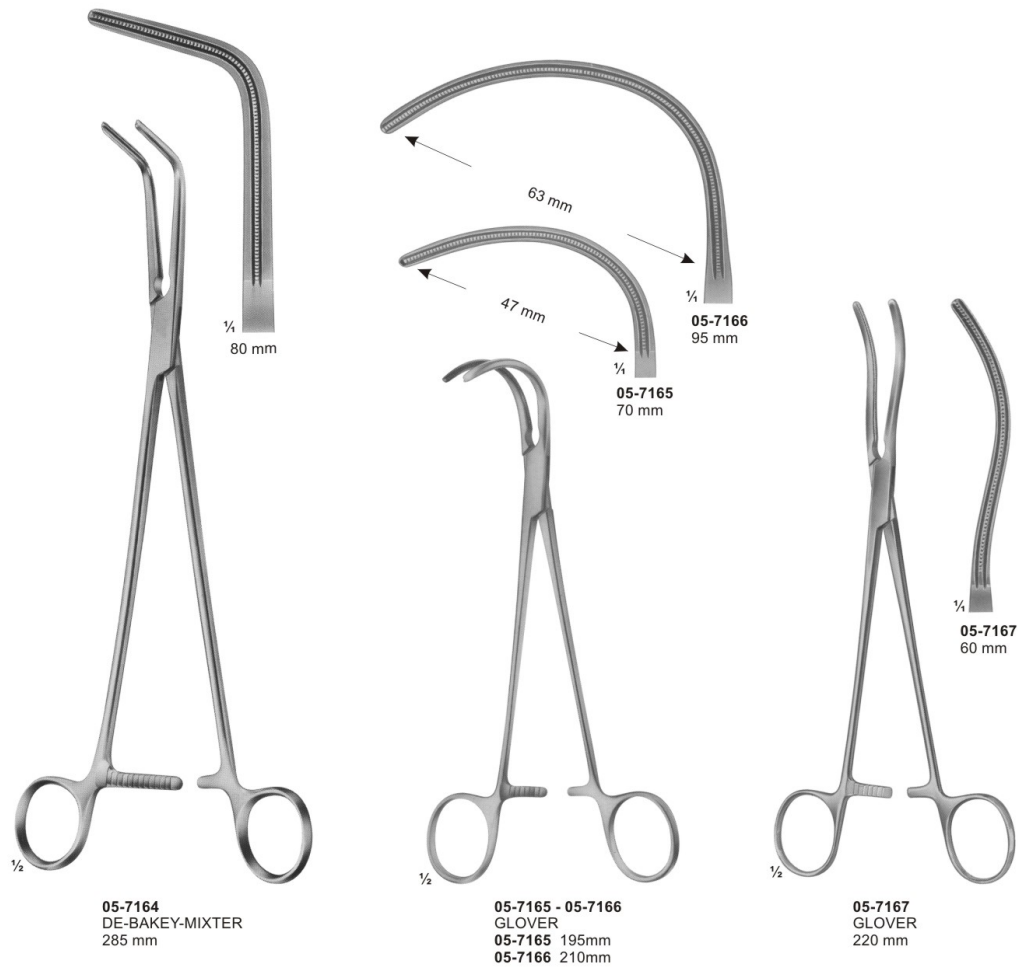

Atraumata Anastomosis, Vena-Cava Clamps

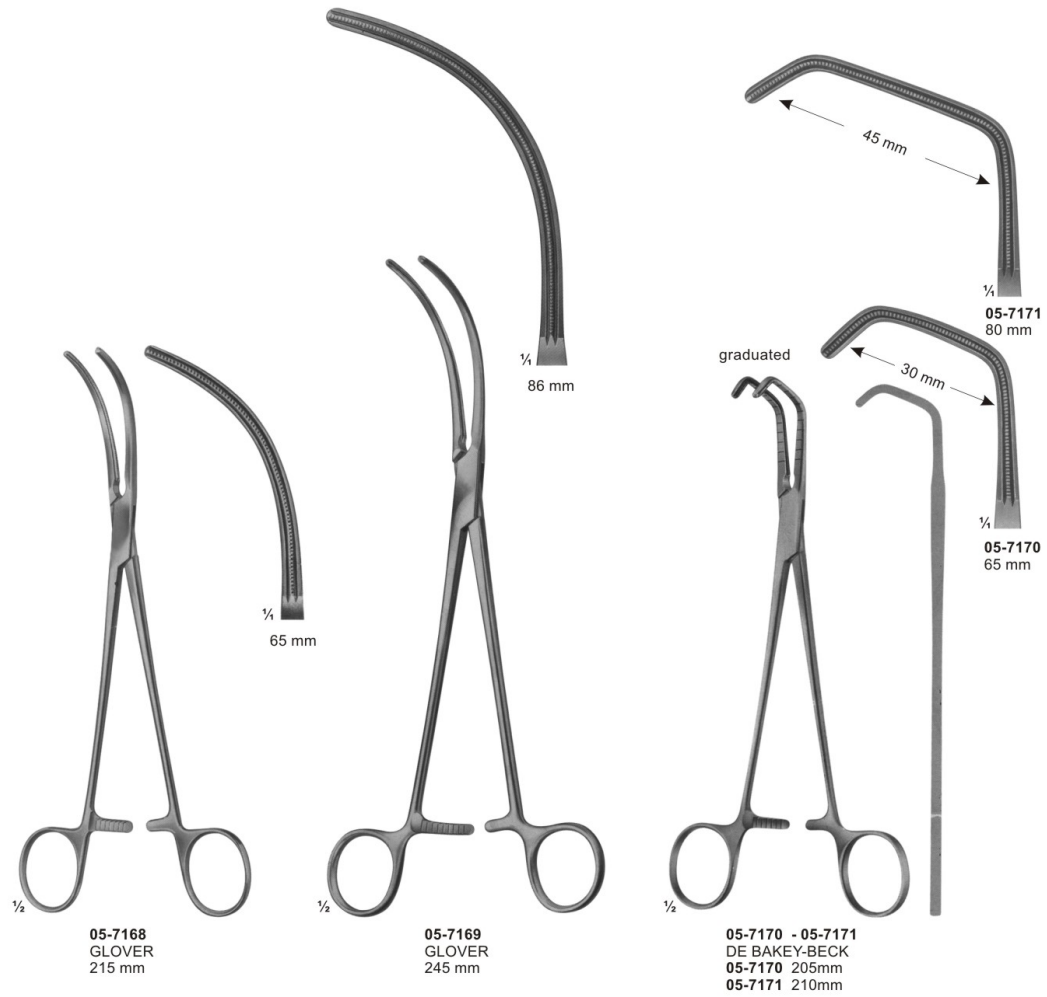

Atraumata Vena-Cava Clamps And Tangential Occlusion Clamps



05-7172 - 05-7175
DE BAKEY-HARKEN
05-7172 - 255 mm
05-7173 - 245 mm
05-7174 - 245 mm
05-7175 - 245 mm

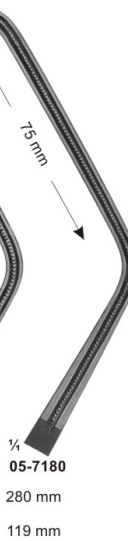
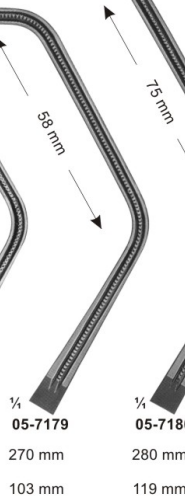
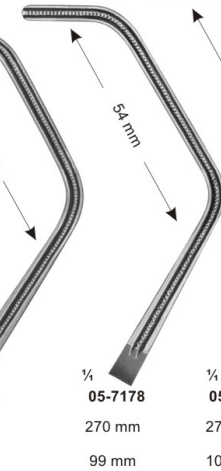
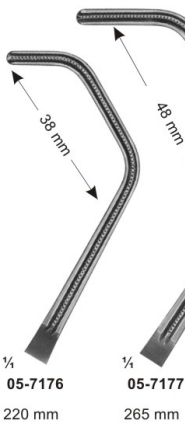

05-7176 - 05-7180
DE BAKEY
Total Length: 220 mm
Length of jaws: 85 mm

05-7176 36 mm

05-7177 48 mm

05-7178 64 mm
270 mm
99 mm

05-7179 58 mm
270 mm
103 mm

05-7180 75 mm
280 mm
119 mm

Atraumata Tangential Occlusion And Coarctation Clamps

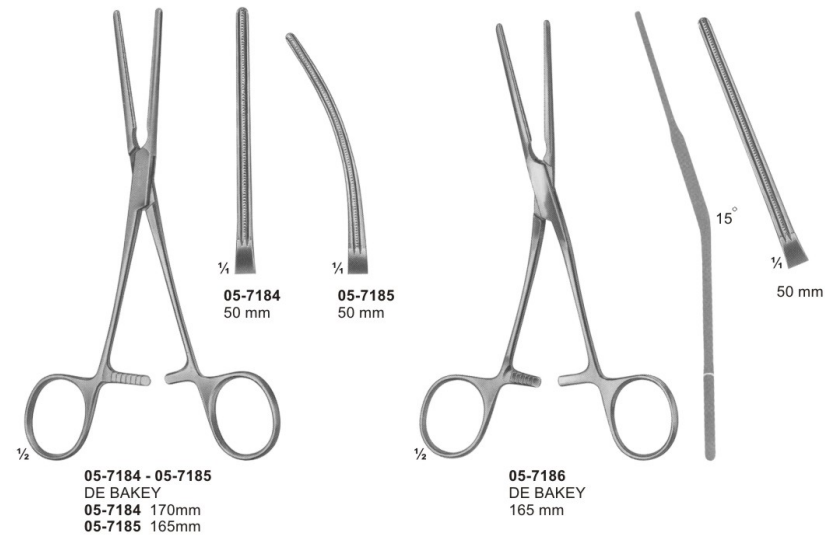
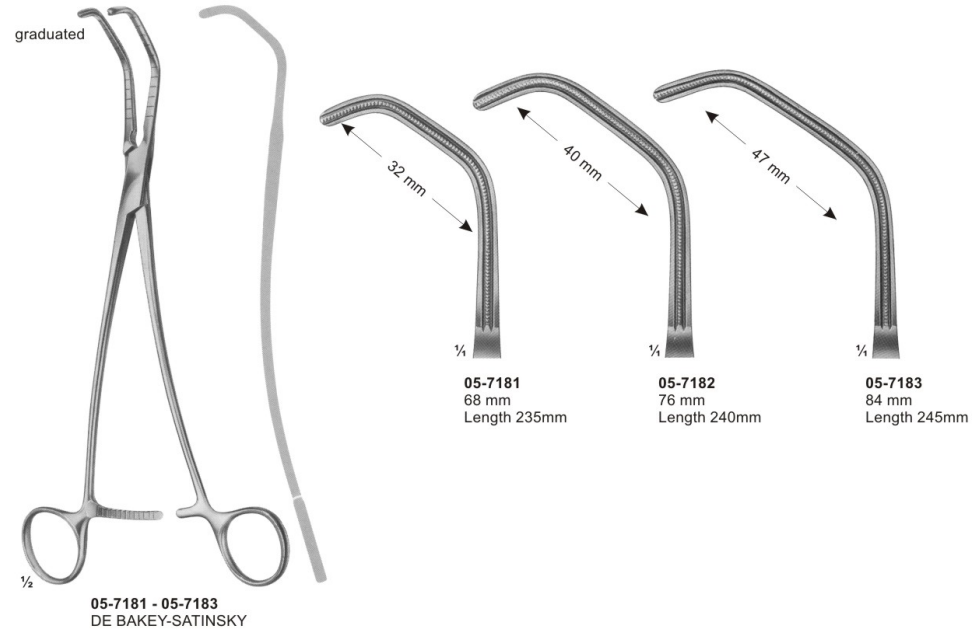

**Atraumata Coarctation Clamps,
Patent-Ducts Clamps**

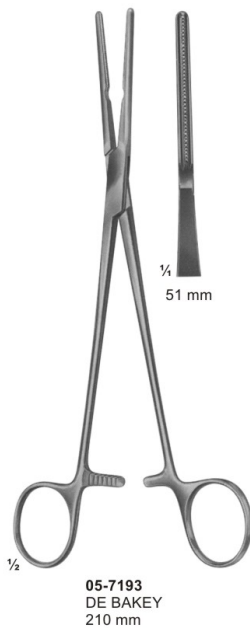
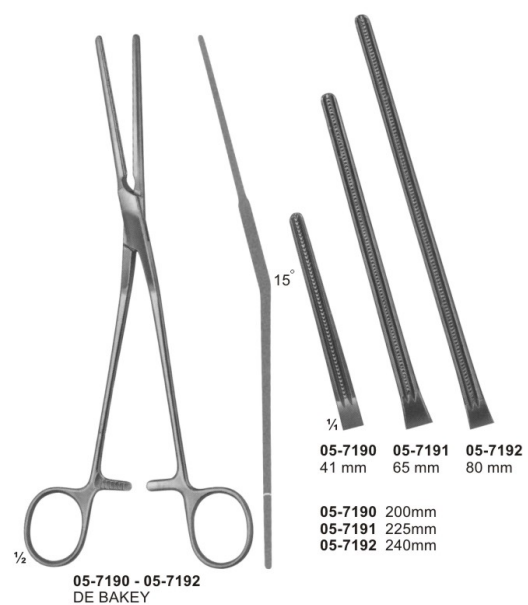
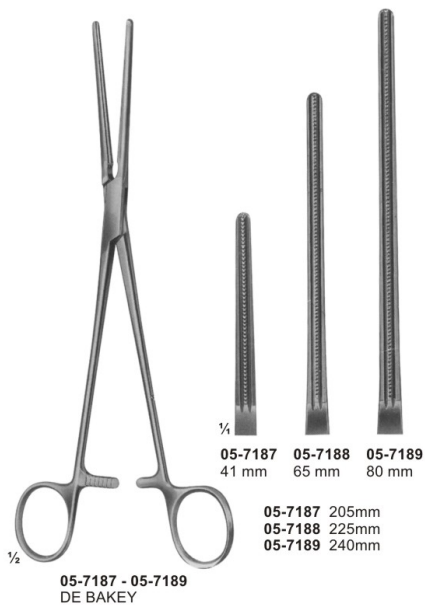

Atraumata Peripheral-Vascular Clamps

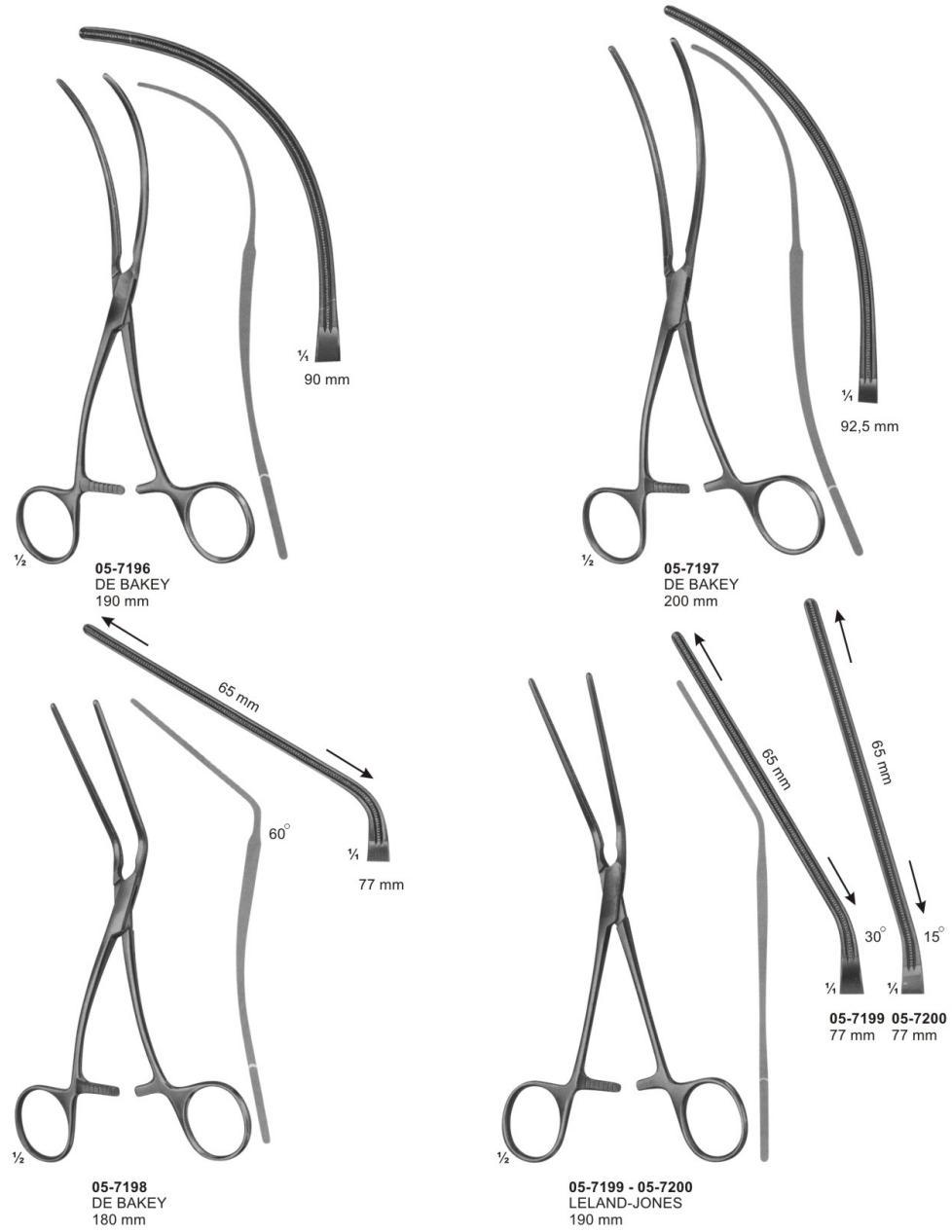

**Atraumata Peripheral Vascular And
Anastomosis Clamps**

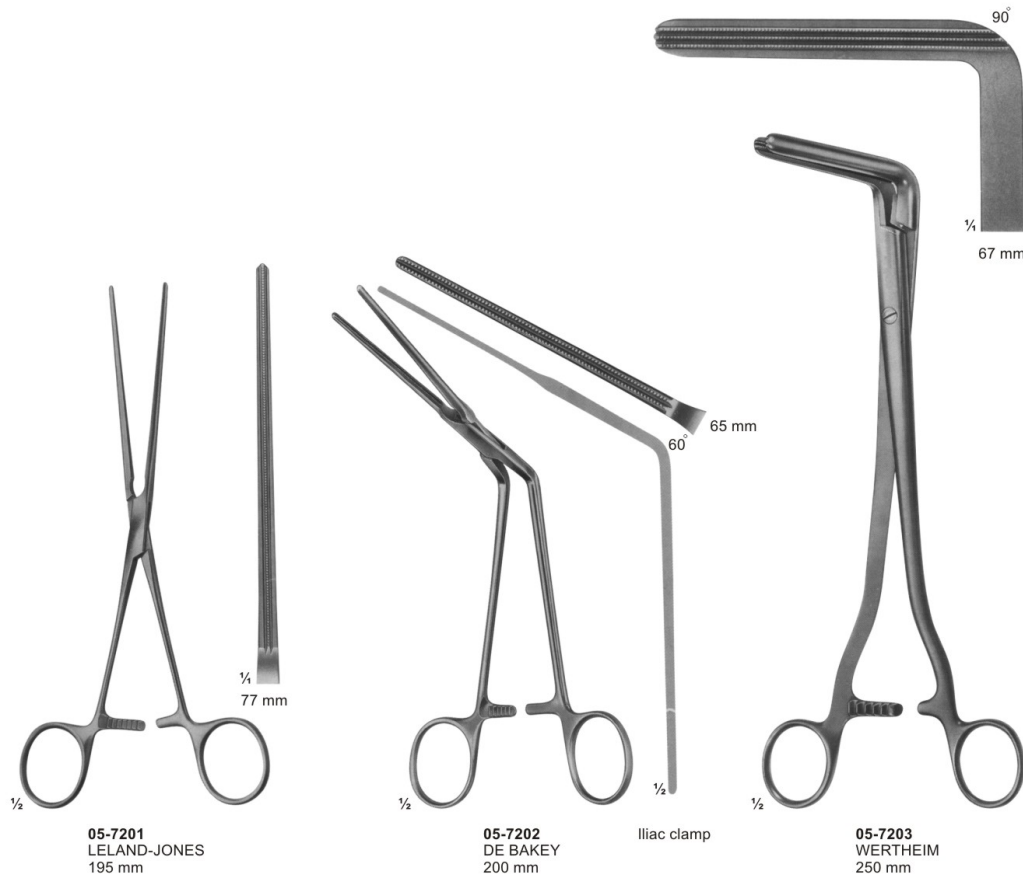

**Atraumata Anastomosis And Ascending
Aotra Cross Clamps**

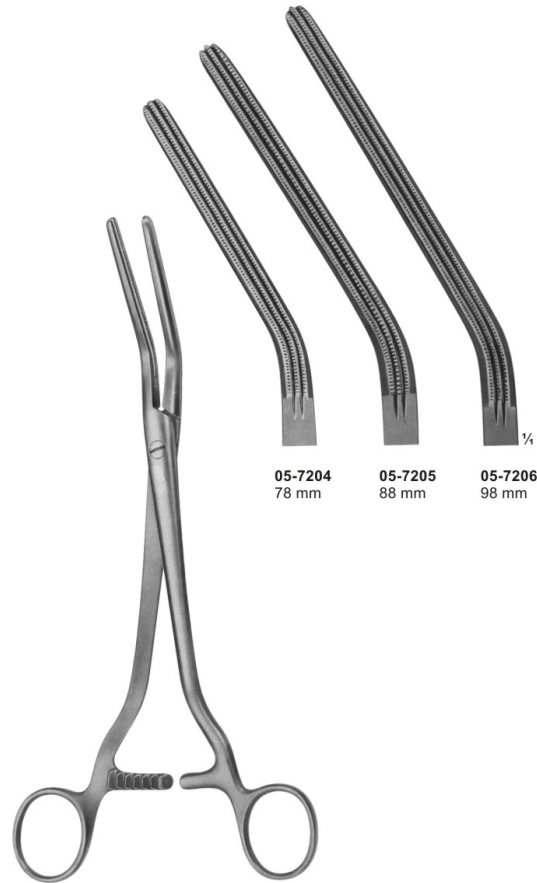

05-7204
78 mm

05-7205
88 mm

05-7206
98 mm

05-7204 - 05-7206
DICK
05-7204 255mm
05-7205 265mm
05-7206 275mm

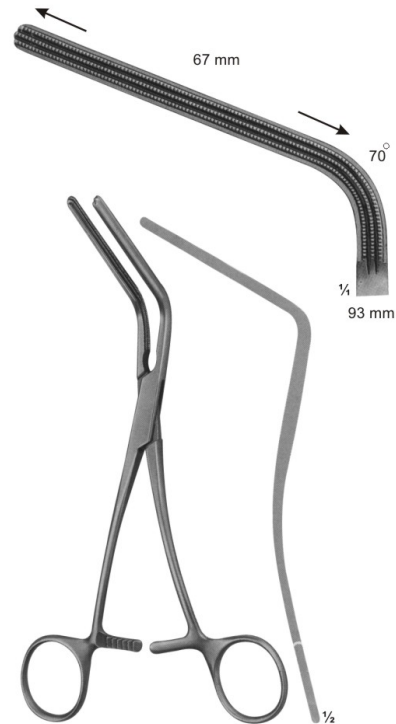

05-7207
MORRIS
175 mm

**Atraumata Ascending Aorta Cross,
Bronchus Clamps**

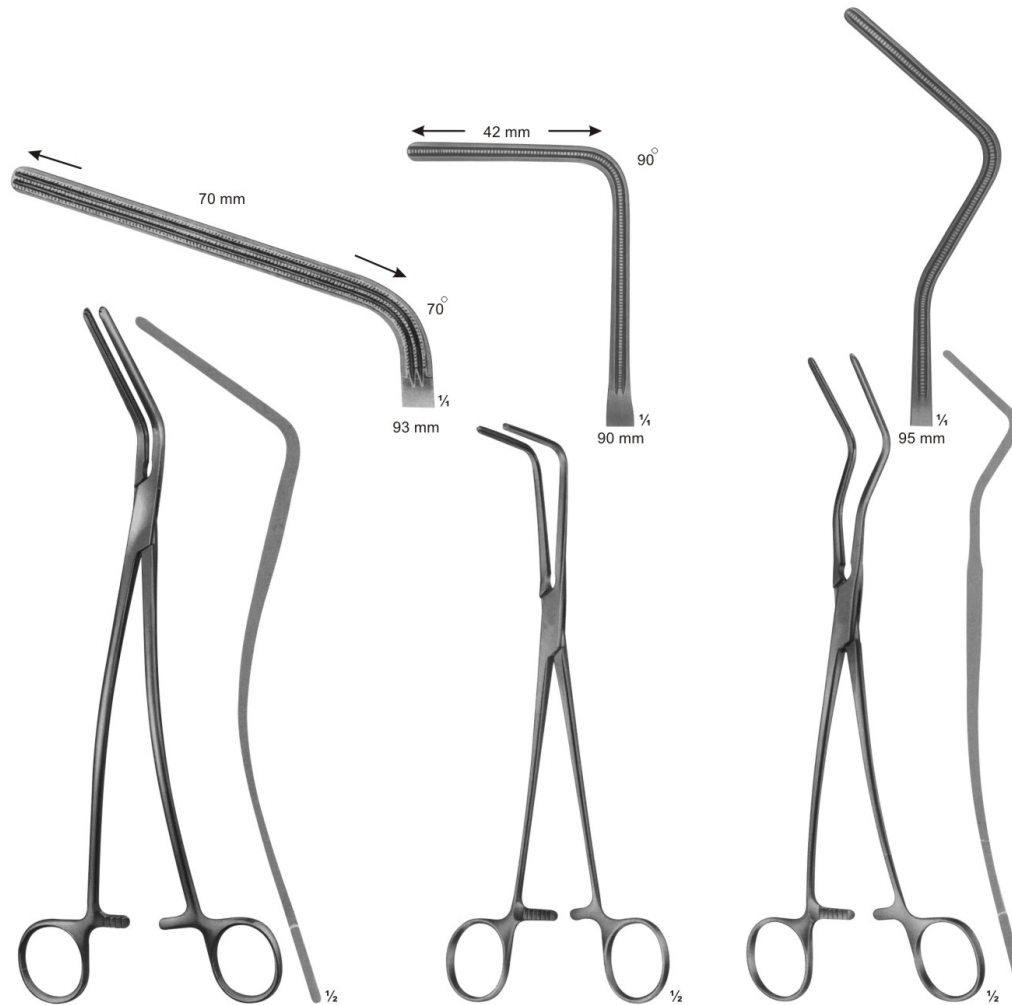

05-7208
DE BAKEY (Morris Modif)
240 mm

05-7209
LEES
220 mm

05-7210
LEES
245 mm

Atraumata Aorta-Aneurysm Clamps

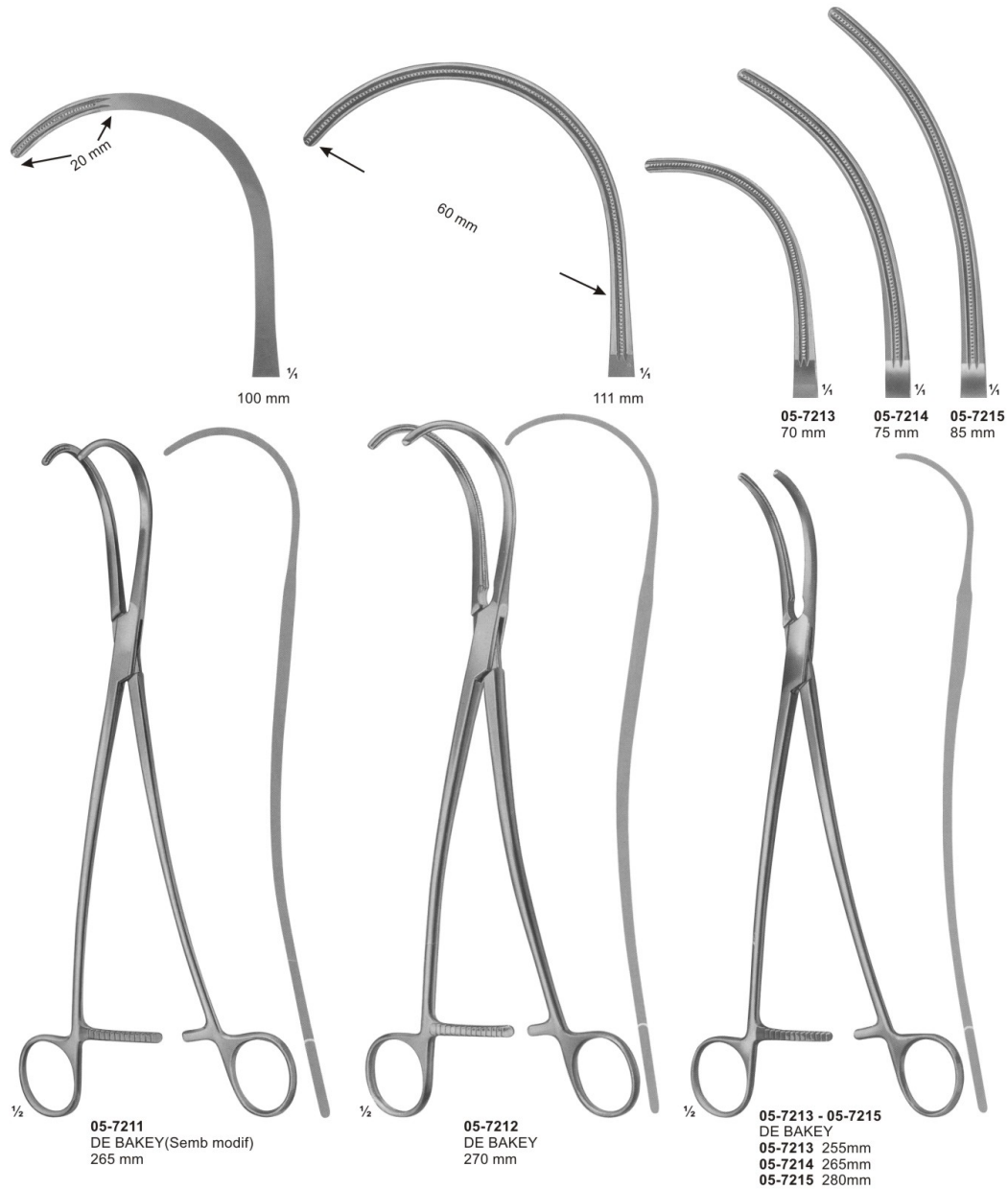

Atraumata Aorta-Aneurysm Clamps

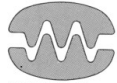

2.3 Teeth Rows

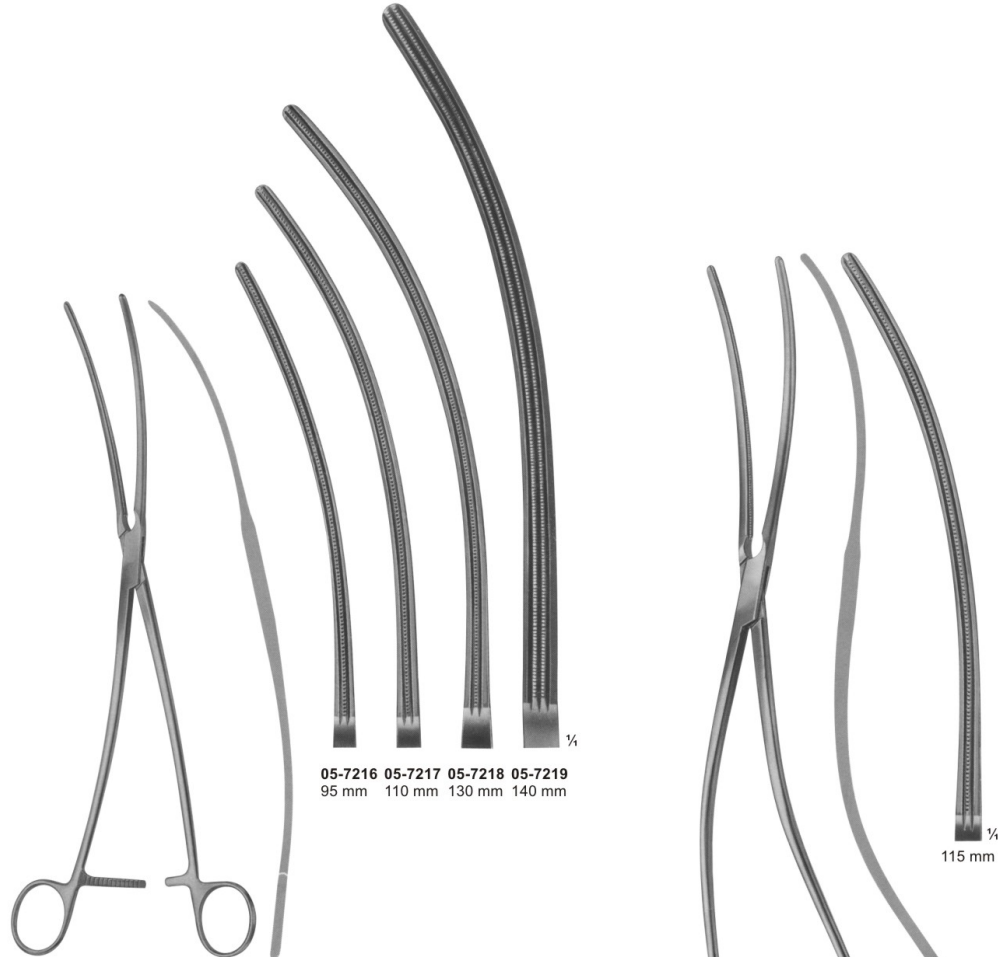

05-7216 05-7217 05-7218 05-7219
95 mm 110 mm 130 mm 140 mm

$\frac{1}{4}$
115 mm

05-7216 - 05-7219
DE BAKEY
05-7216 250mm
05-7217 300mm
07-7218 315mm
07-7219 330mm

05-7220
DE BAKEY
300 mm

Atraumata Aorta Clamps

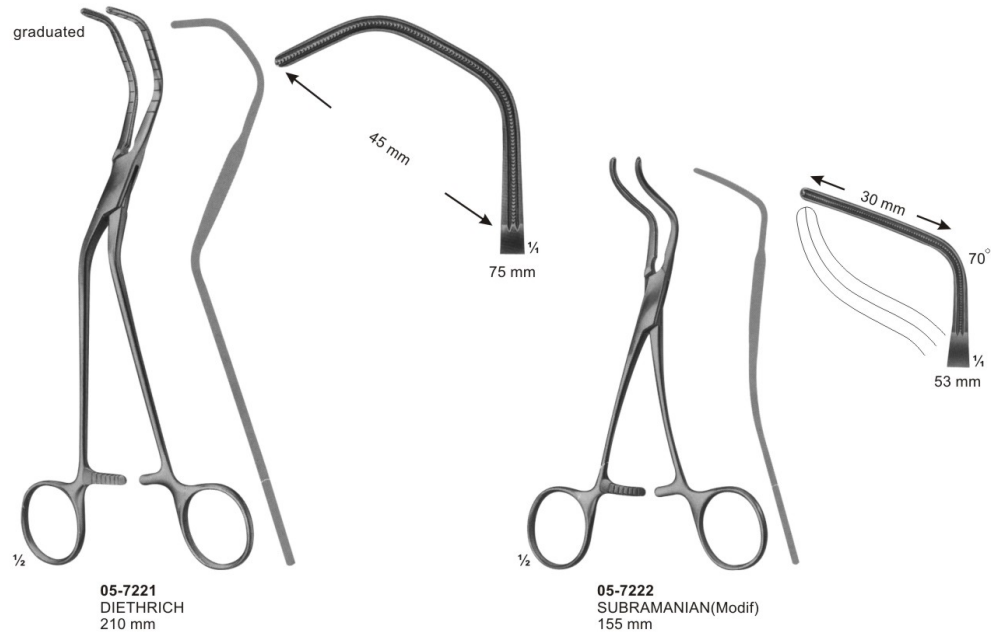

Atraumata Aorta Clamps

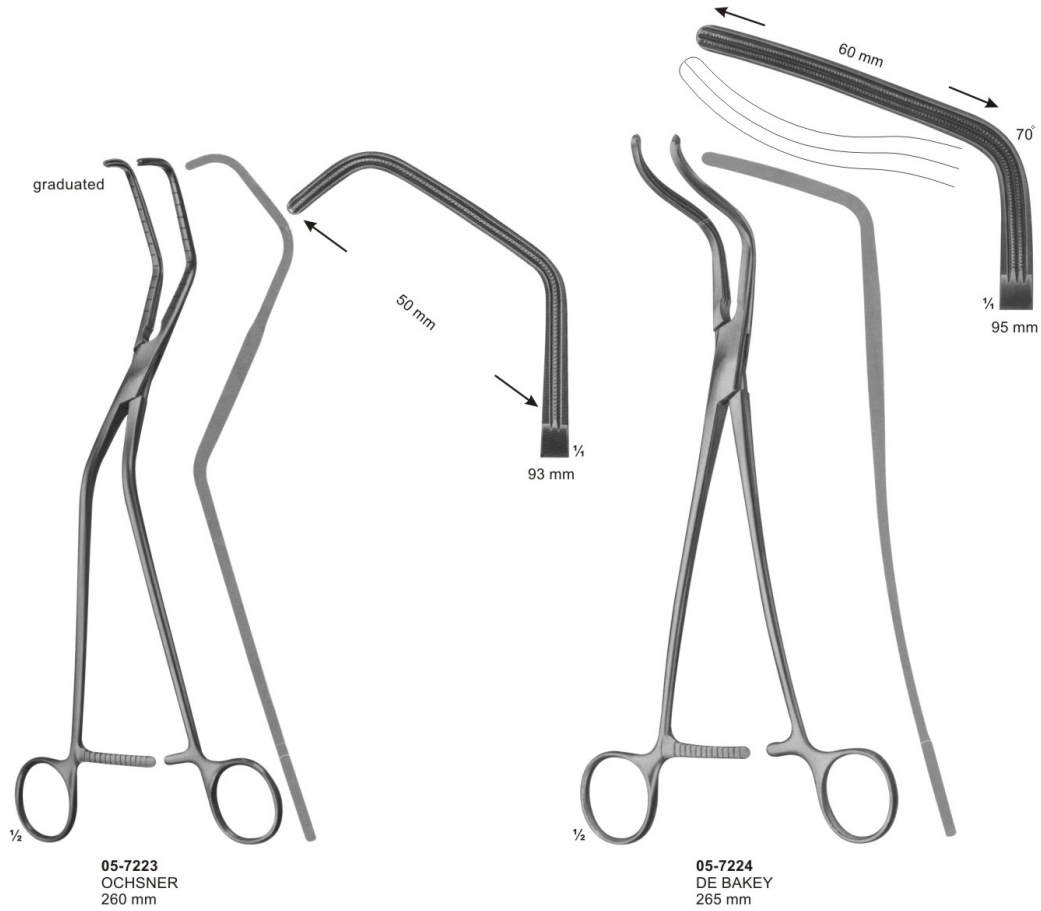

Atraumata Aorta-Anastomosis Clamps

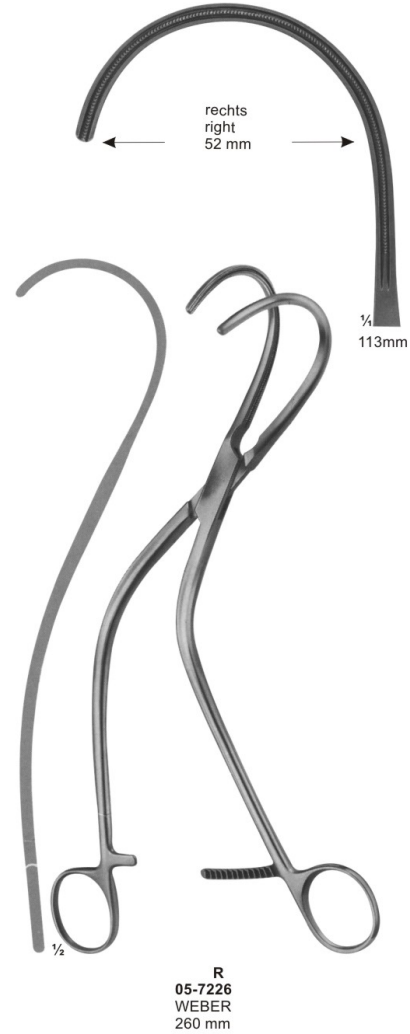
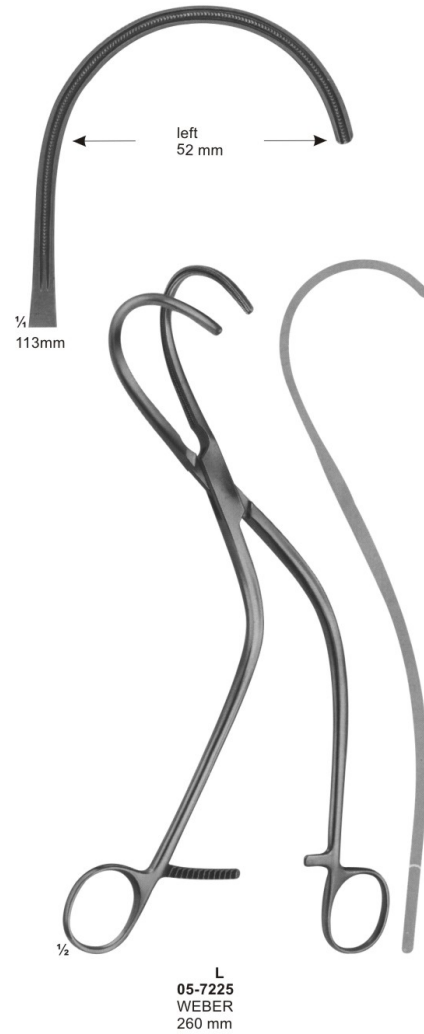

Multi-Purpose Clamps



½ 05-7227 - 05-7230
DE BAKEY

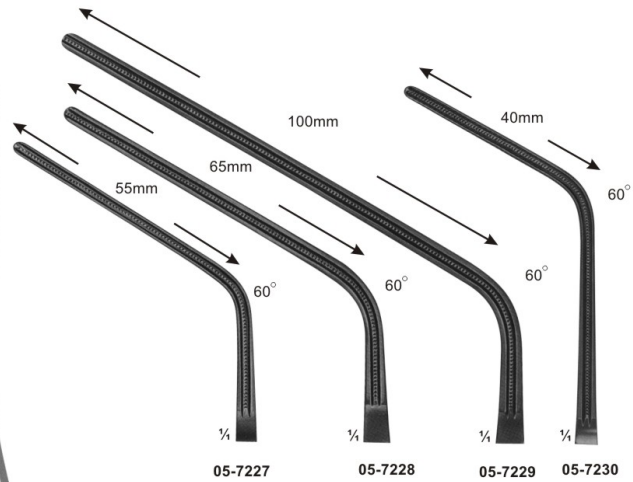

Total Length:	230 mm	280 mm	305 mm	240 mm
Length of jaws:	85 mm	100 mm	135 mm	93 mm



½ 05-7231 - 05-7234
DE BAKEY

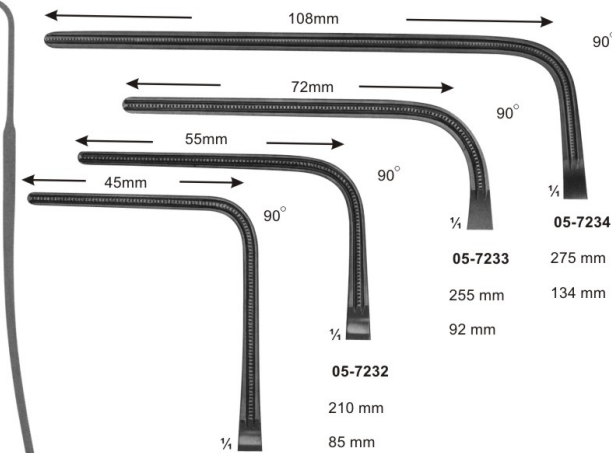

Total Length:	225 mm	210 mm	255 mm	108 mm
Length of jaws:	93 mm	85 mm	134 mm	72 mm

**Ring Handle Bulldog Clamps Anastomosis
Clamps, Pediatric Types**

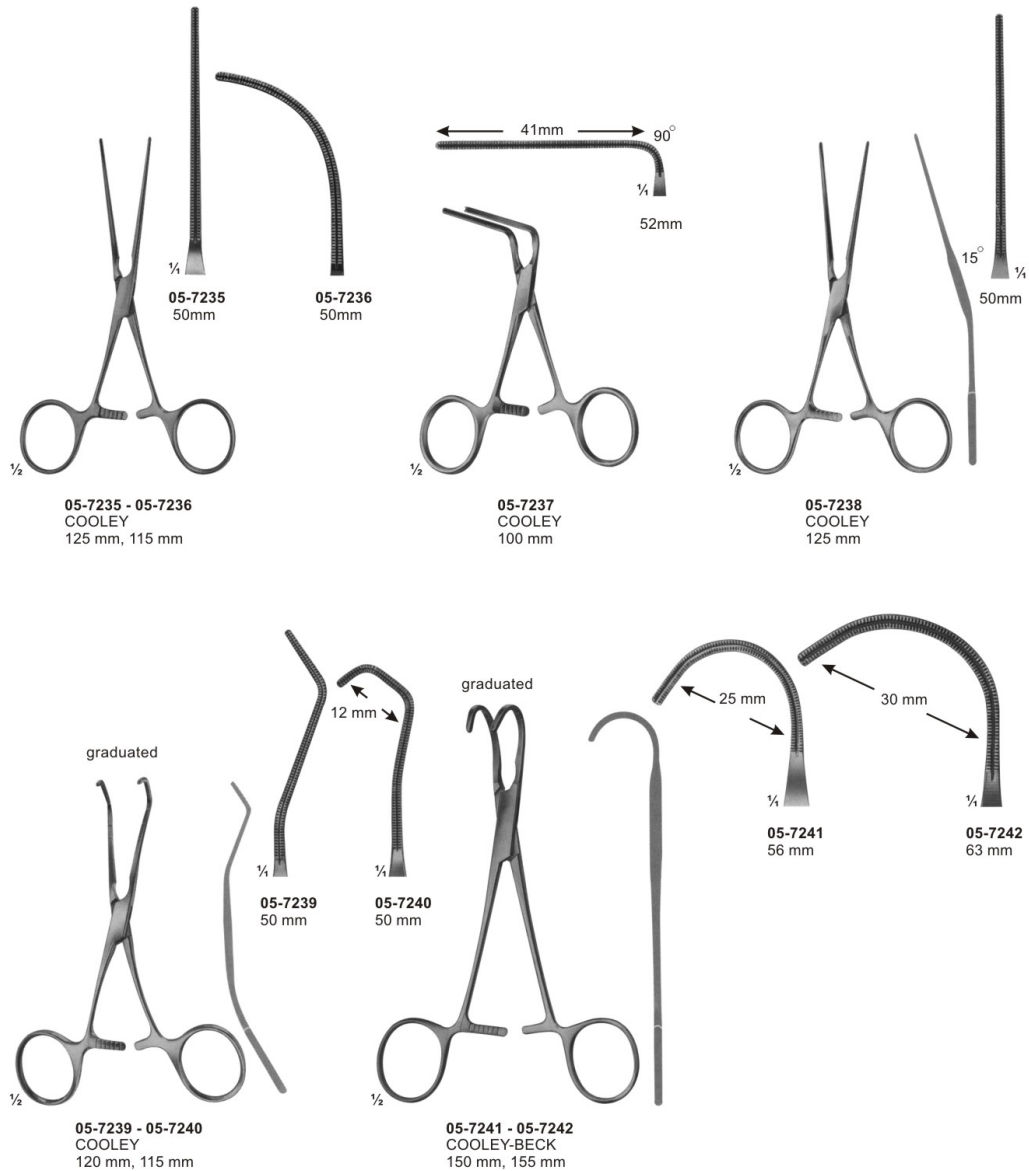

Anastomosis Clamps, Pediatric Types

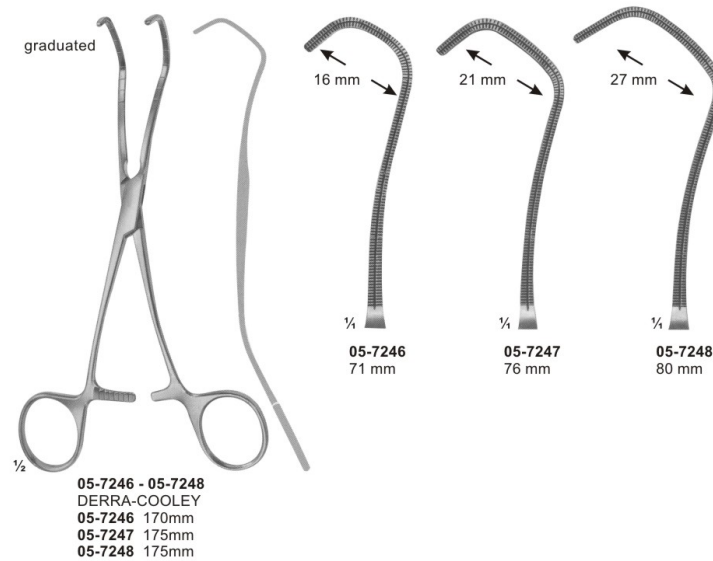
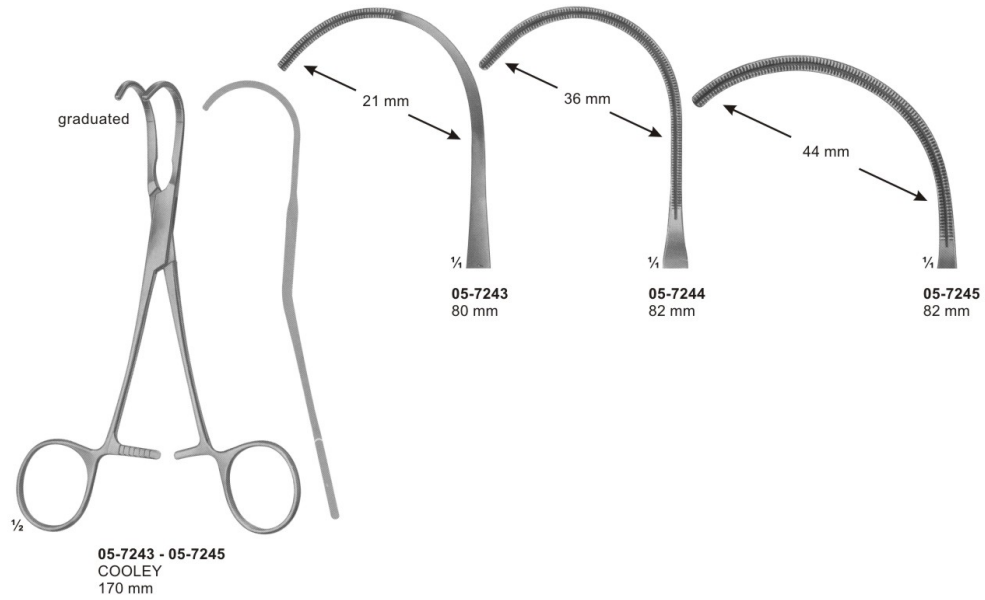

**Anastomosis Clamps Multi-Purpose
Clamps Pediatric Types**

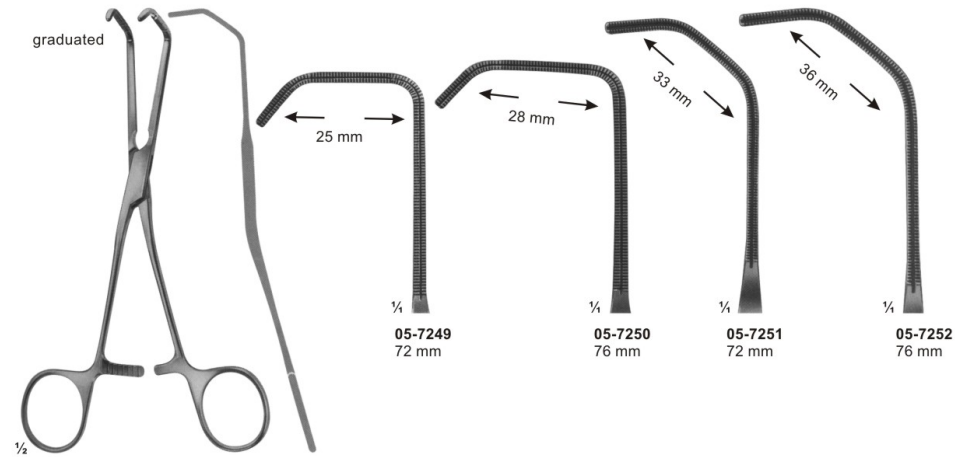

05-7249 - 05-7252
COOLEY
05-7249 165mm
05-7250 165mm
05-7251 175mm
05-7252 180mm

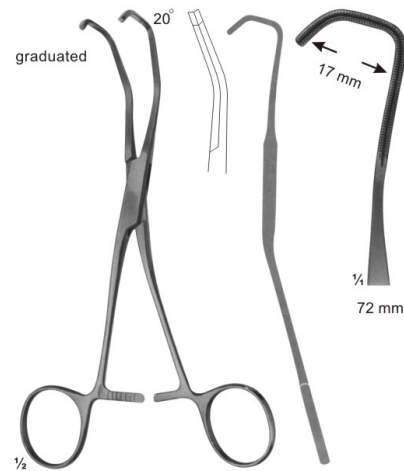

05-7253
COOLEY
170 mm

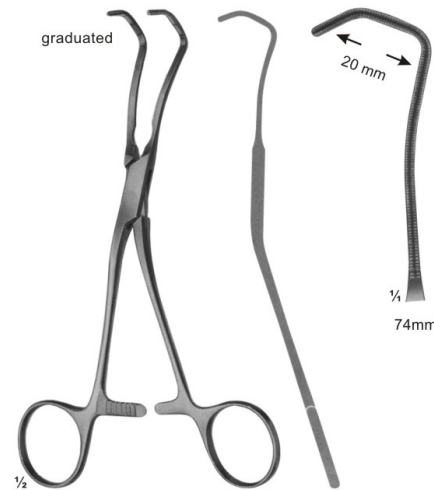

05-7254
COOLEY
175 mm

Multi-Purpose Clamps, Pediatric Types

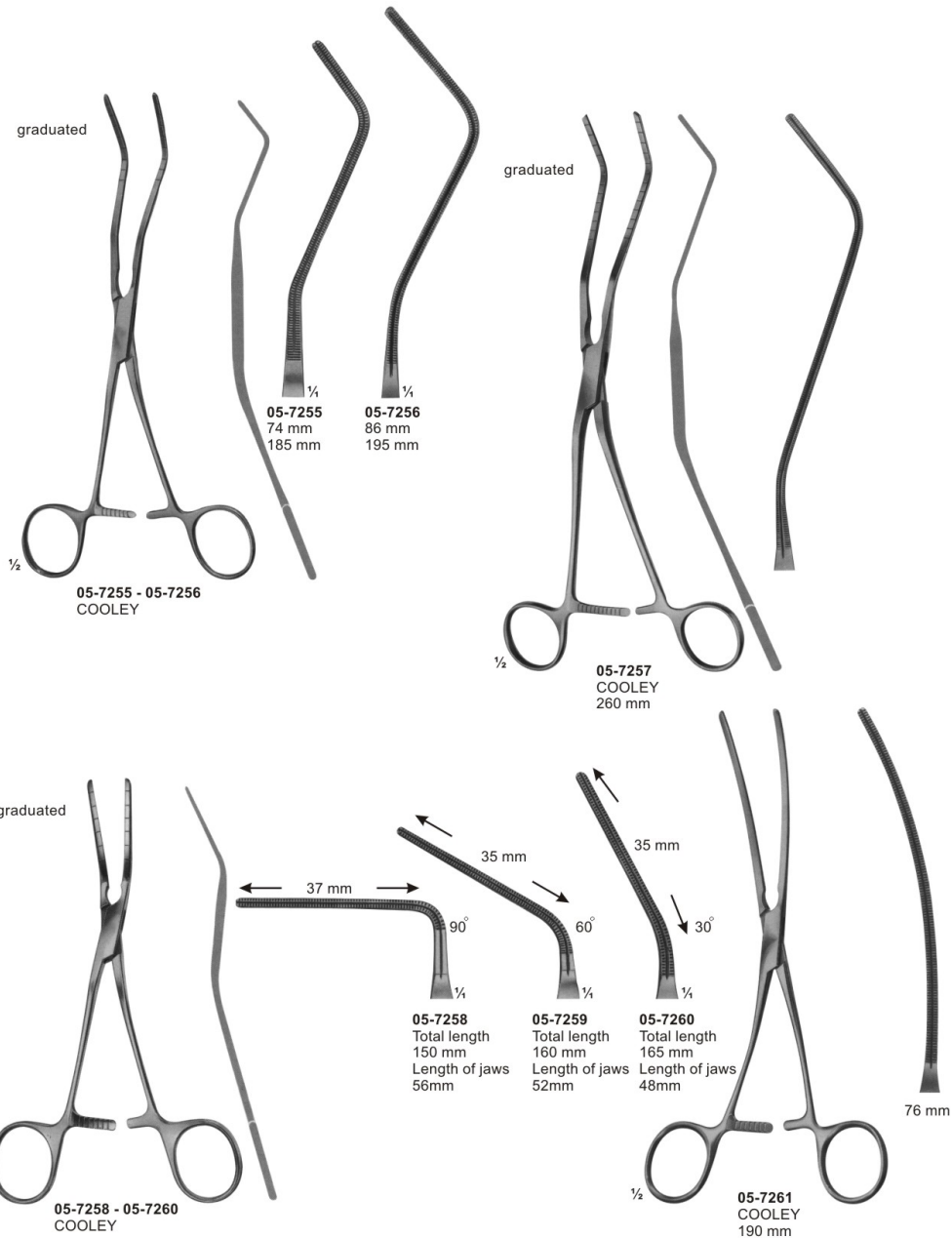

**Atraumata Aorta Clamps, Patent-Ductus
Clamps, Coarctation Clamps Pediatric Types**

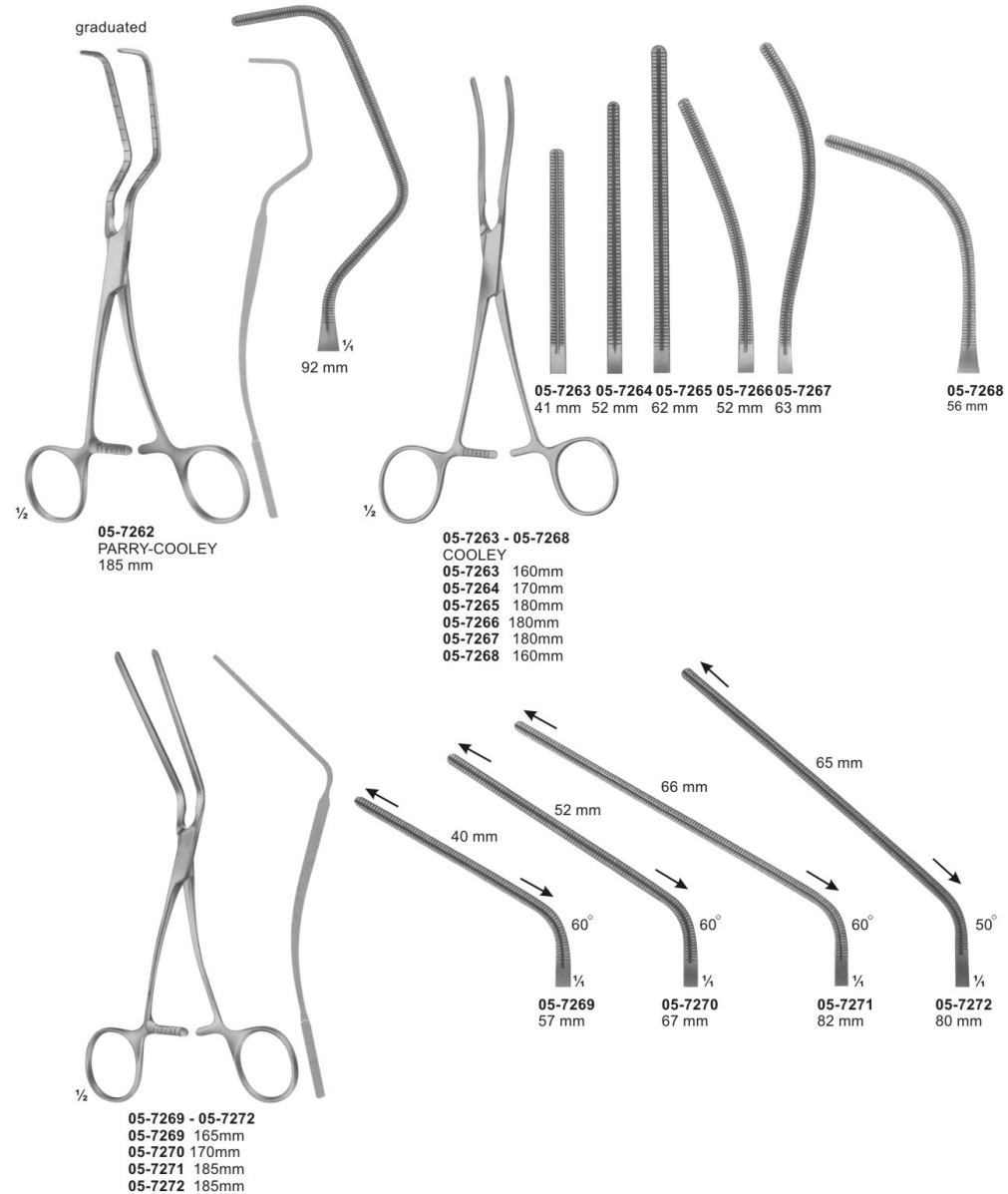

Multi-Purpose Clamps



05-7273 - 05-7282
DARDIK
05-7273 150 mm **05-7278** 170 mm
05-7274 150 mm **05-7279** 170 mm
05-7275 150 mm **05-7280** 170 mm
05-7276 145 mm **05-7281** 160 mm
05-7277 130 mm **05-7282** 135 mm

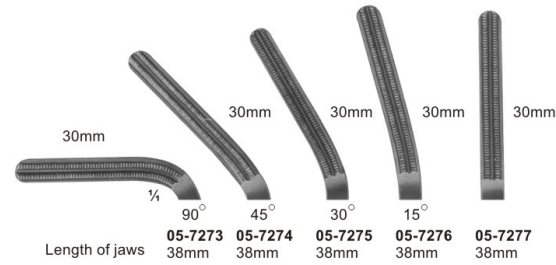

Length of jaws **05-7273** 38mm **05-7274** 38mm **05-7275** 38mm **05-7276** 38mm **05-7277** 38mm

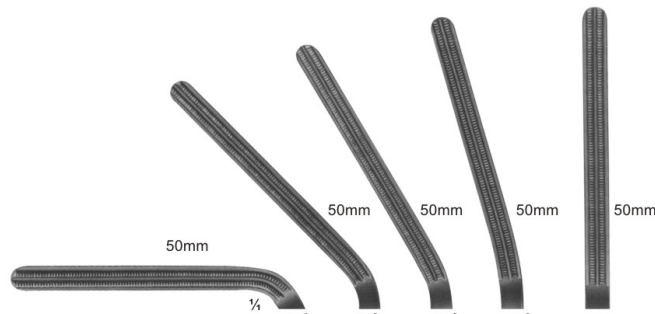

Length of jaws **05-7278** 58mm **05-7279** 58mm **05-7280** 58mm **05-7281** 58mm **05-7282** 58mm

Lung Grasping Forceps



05-7283
WILLIAMS
160 mm



05-7284
TUTTLE
230 mm



05-7285
NELSON
230 mm

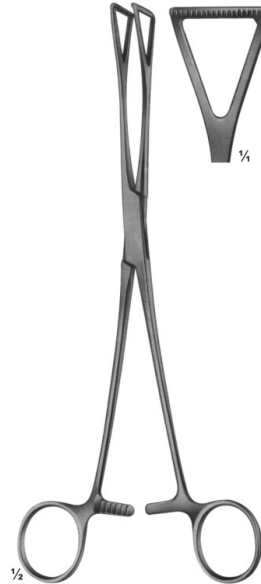

05-7286
DUVAL
230 mm

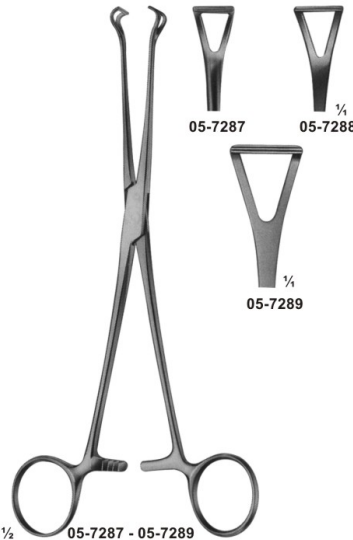

05-7287 - 05-7289
BABCOCK
05-7287 170 mm
05-7288 215 mm
05-7289 220 mm



05-7290
ALLIS
220 mm

Dissecting And Ligature Forceps

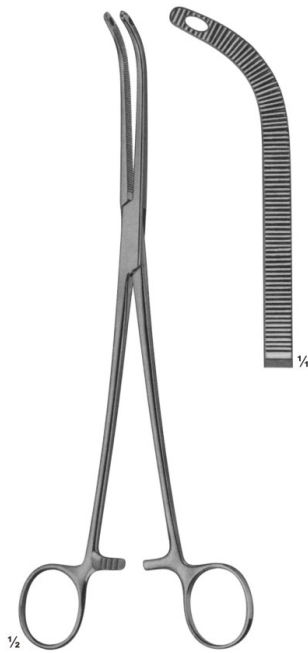

05-7291
FINOCHIETTO
245 mm

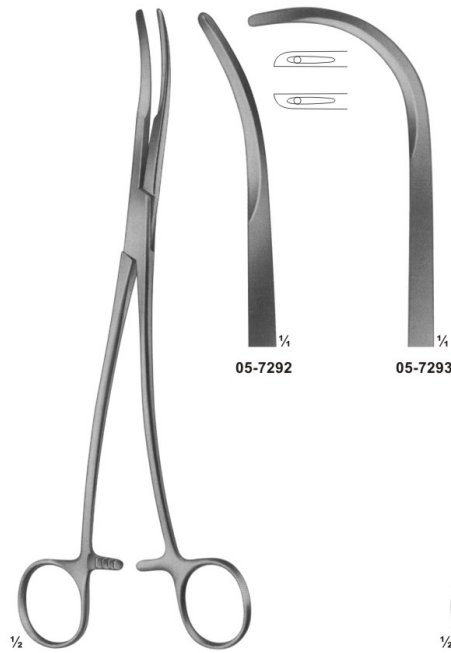

05-7292 - 05-7293
SEMB
240 mm



05-7294
WIKSTROEM
205 mm

**Dissecting And Ligature Forceps,
Vessel Clamps**

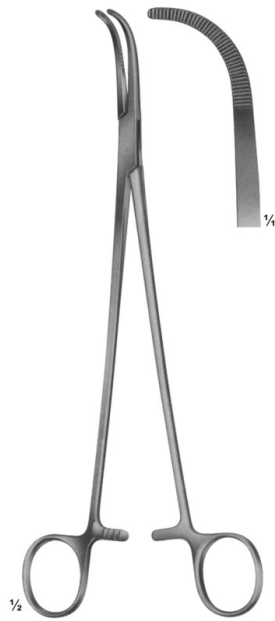

05-7295
MIXTER
230 mm

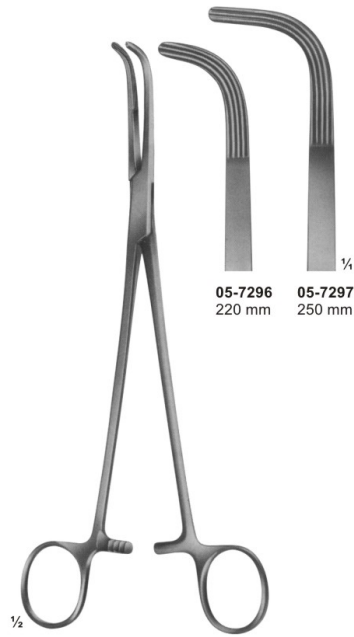

05-7296 - 05-7297
MIXTER

05-7296
220 mm

05-7297
250 mm

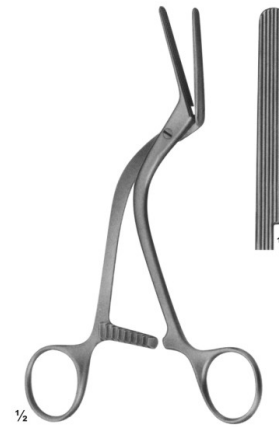

05-7298
HOEPFNER
Vessel clamp
160 mm

Vena Cava Clamps

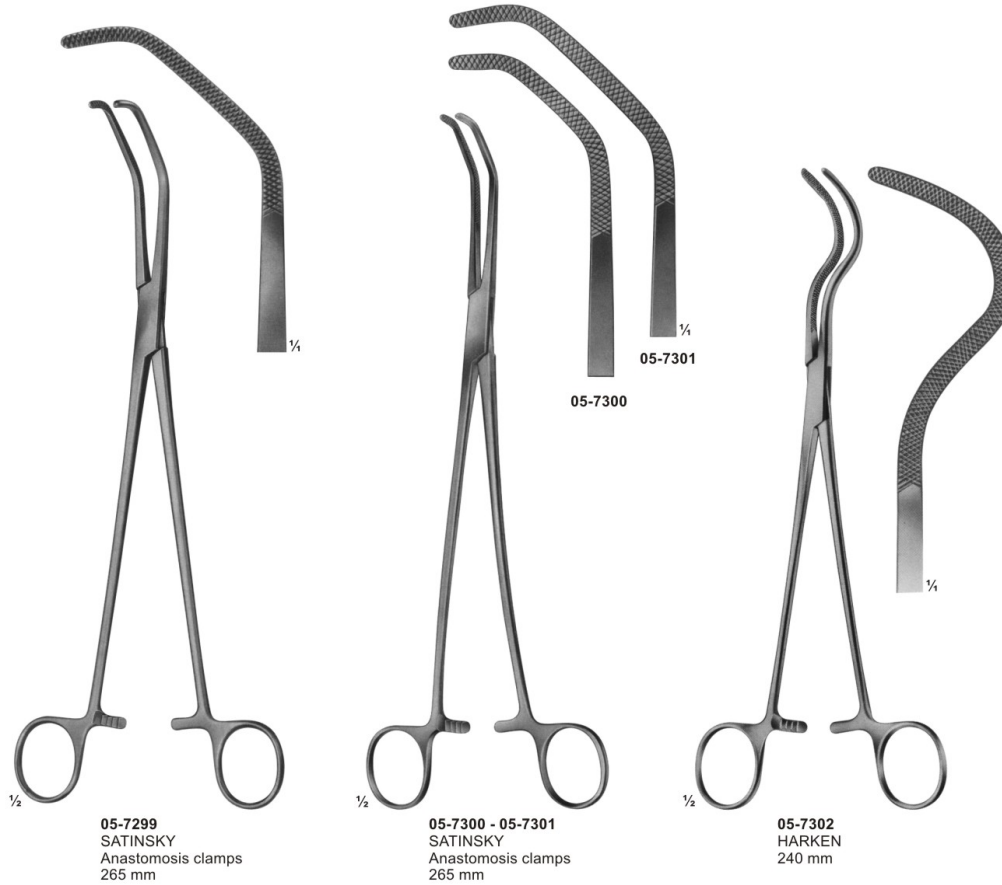

Carotid Clamps, Auricle Clamps



05-7303
PERTUISET
Carotid Clamp
90 mm

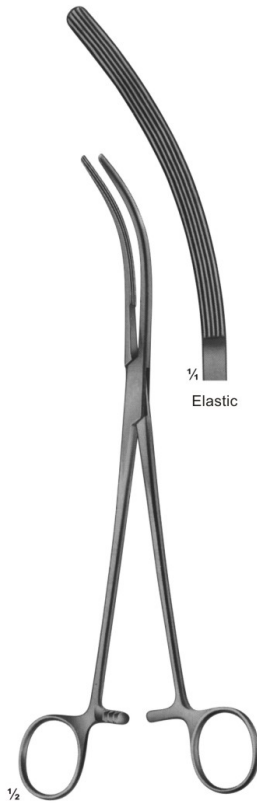

05-7304
CRAFOORD-SELLORS
240 mm

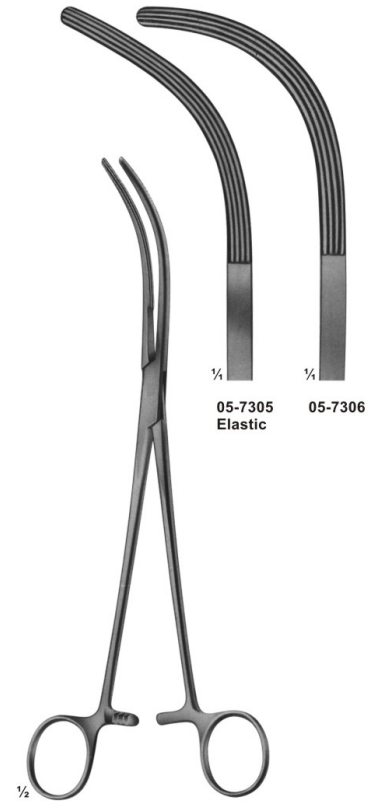

05-7305 - 05-7306
CRAFOORD
240 mm

Bronchus Forceps



05-7307
PRICE THOMAS
225 mm



05-7308
jaws with pins

05-7309
jaws with pins

05-7308 - 05-7309
PRICE THOMAS
225 mm

Sternum Instruments And Rib Shears



05-7310
SCHUMACHER
Sternum shears
210 mm



05-7311
LEBSCHKE
Sternum chisel
200 mm



05-7312
230 mm



05-7313
COLLIN
195 mm



05-7314
GLUCK
190 mm



05-7315
BETHUNE
340 mm



05-7316
BRUNNER
Universal Pattern
340 mm



05-7317
GIERTZ-STILLE
250 mm

**Rib Holding Forceps, Bone Cutting Forceps,
Rib Rongeurs**



05-7318
SEMB
Rib-and Bone
Holding forceps
190 mm



05-7319
SEMB
Rib-and Bone
Holding forceps
190 mm



05-7320
LISTON-STILLE
265 mm

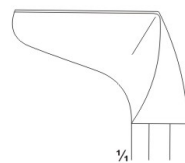

05-7321
LISTON-KEY-HORSLEY
(Tudor Edwards)
255 mm

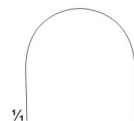

05-7323

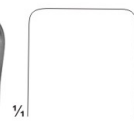

05-7324

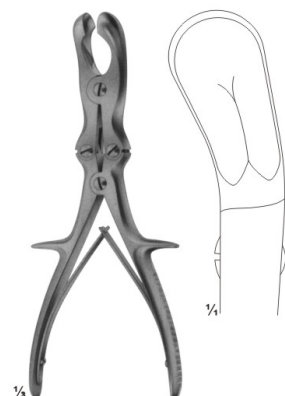

05-7322
SEMB
Rib Rongeur to shorten
the rib stumps
240 mm



05-7323 - 05-7324
SAUERBRUCH-CORYLLOS
Rib rongeurs to shorten
the rib stumps
310 mm

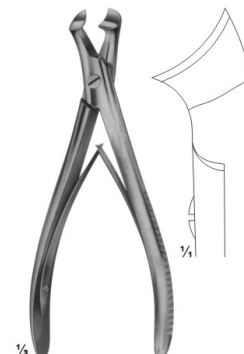

05-7325
MARKWALDER
Rib Rongeur to Round
the rib stumps
190 mm

Rib Raspatories



Rib Raspatories



1/2
05-7332 - 05-7336
SEMB
230 mm

12 mm



05-7332
190 mm

12 mm

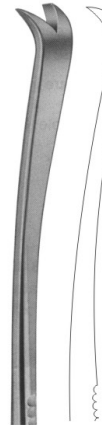

05-7333
230mm

13 mm

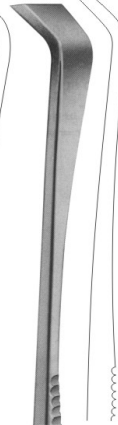

05-7334
230mm

13 mm



05-7335
230mm

15 mm

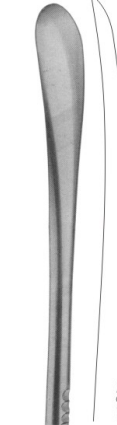

05-7336
230mm

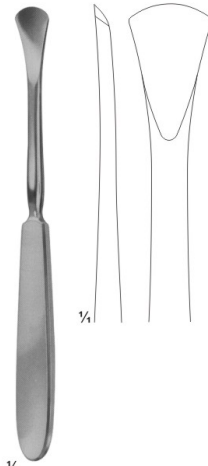

1/2
05-7337
LANGENBECK
190 mm

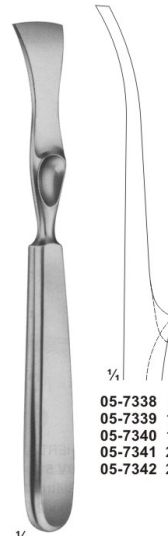

1/2
05-7338 - 05-7342
LAMBOTTE
215 mm

- 05-7338 5 mm
- 05-7339 10 mm
- 05-7340 15 mm
- 05-7341 20 mm
- 05-7342 25 mm

10mm

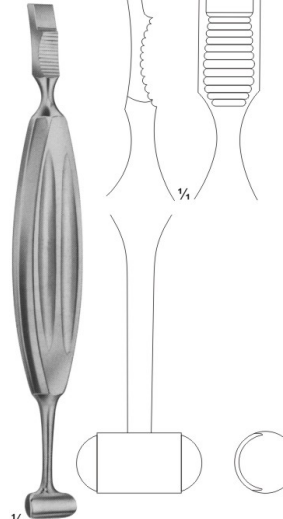

1/2
05-7343
ALEXANDER
210 mm

Rib Spreaders

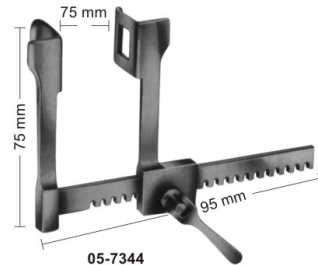

05-7344
FINOCHIETTO
Blades
18X21 mm



05-7345
HERTZLER
Blades
20X25 mm

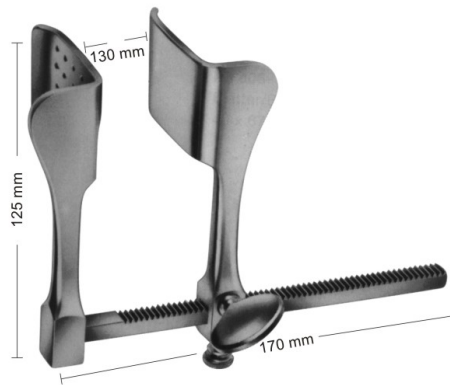

05-7346
TUFFIER
Blades
43X53 mm

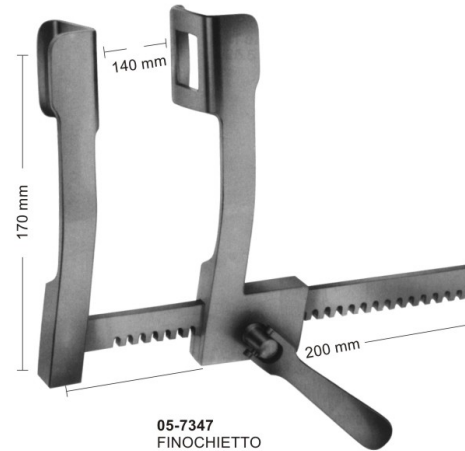

05-7347
FINOCHIETTO
Blades
36X45 mm

Rib Spreaders

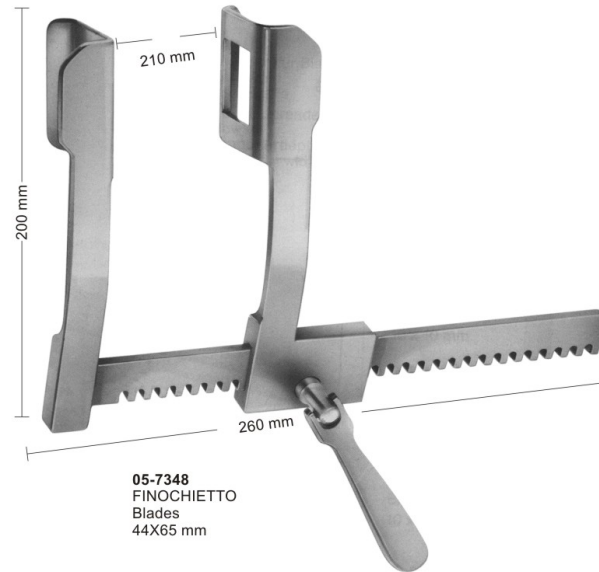

05-7348
FINOCHIETTO
Blades
44X65 mm

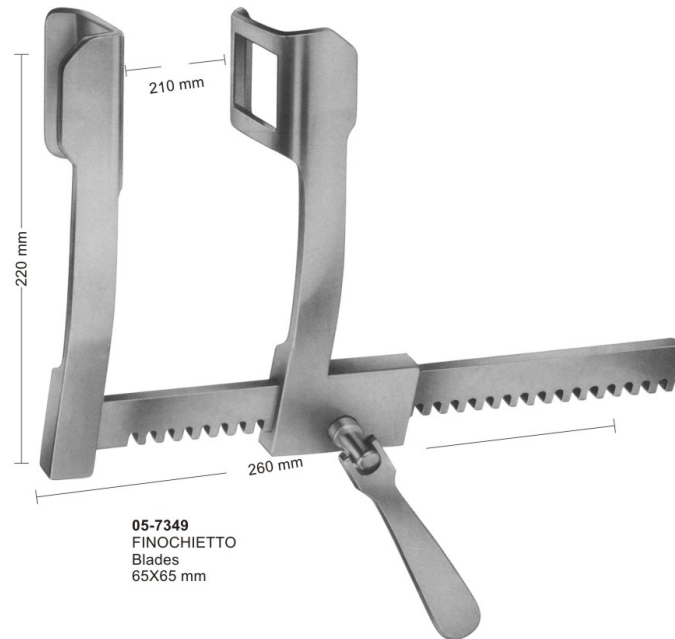

05-7349
FINOCHIETTO
Blades
65X65 mm

301

Rib Spreaders

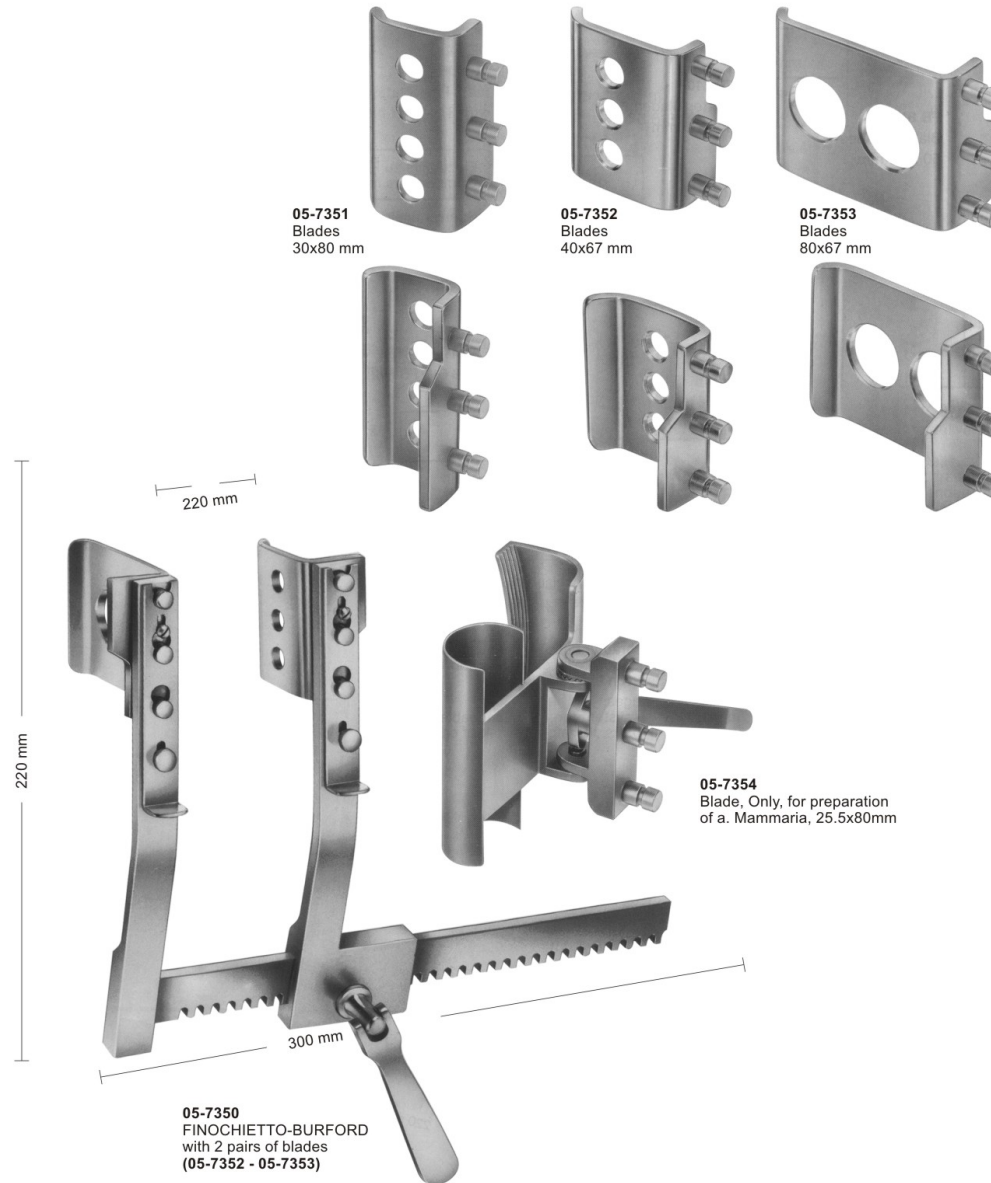

Rib Spreaders

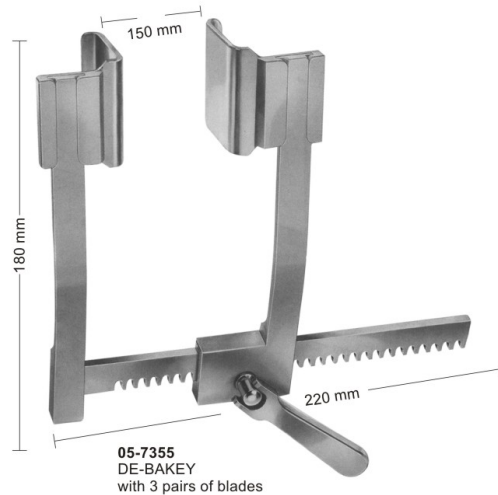

05-7355
DE-BAKEY
with 3 pairs of blades

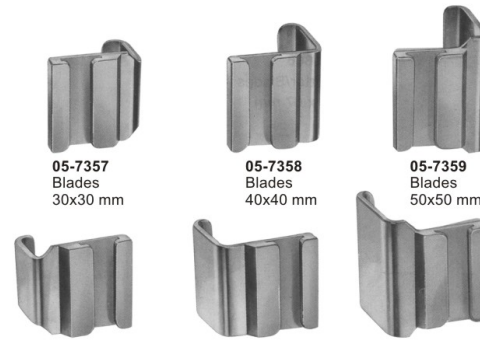

05-7357
Blades
30x30 mm

05-7358
Blades
40x40 mm

05-7359
Blades
50x50 mm

Components for **05-7355**
Spreader only Blades only
05-7357 30x30mm
05-7358 40x40mm
05-7359 50x50mm
The Blades are delivered in Pairs.

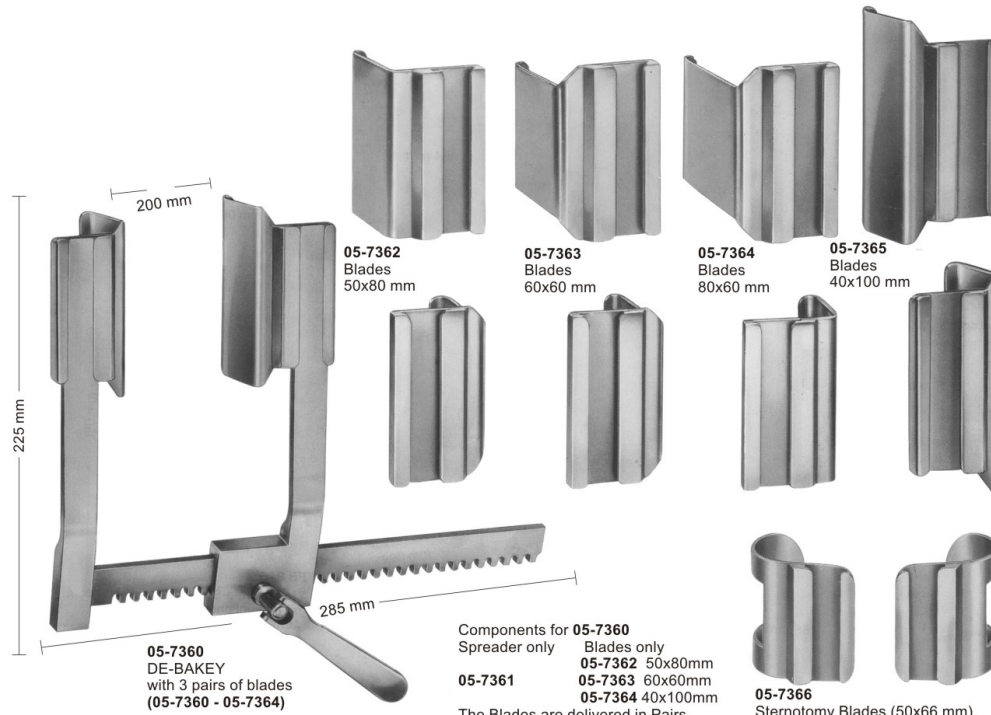

05-7360
DE-BAKEY
with 3 pairs of blades
(**05-7360** - **05-7364**)

05-7362
Blades
50x80 mm

05-7363
Blades
60x60 mm

05-7364
Blades
80x60 mm

05-7365
Blades
40x100 mm

Components for **05-7360**
Spreader only Blades only
05-7362 50x80mm
05-7363 60x60mm
05-7364 40x100mm
The Blades are delivered in Pairs.

05-7366
Sternotomy Blades (50x66 mm)

Sternotomy Spreaders

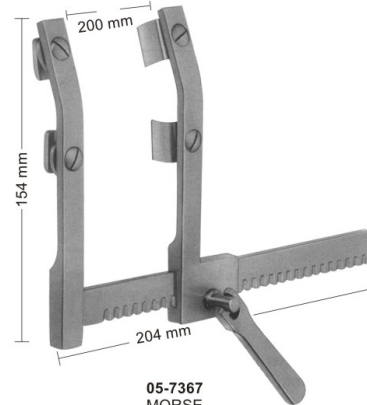

05-7367
MORSE
Sternotomy spreader
for children, with moveable
double, blades each blade
12x20 mm

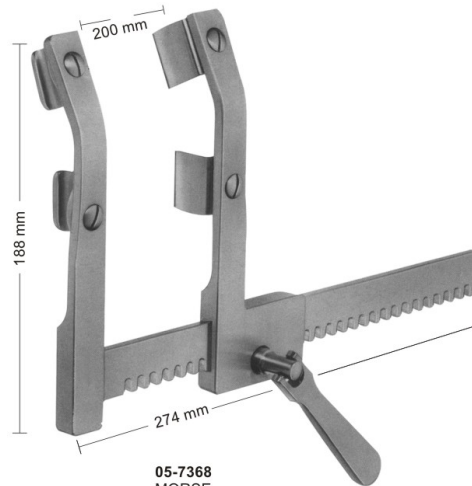

05-7368
MORSE
Sternotomy spreader
for adults, with moveable
double, blades each blade
19x19 mm

Sternotomy- Spreaders

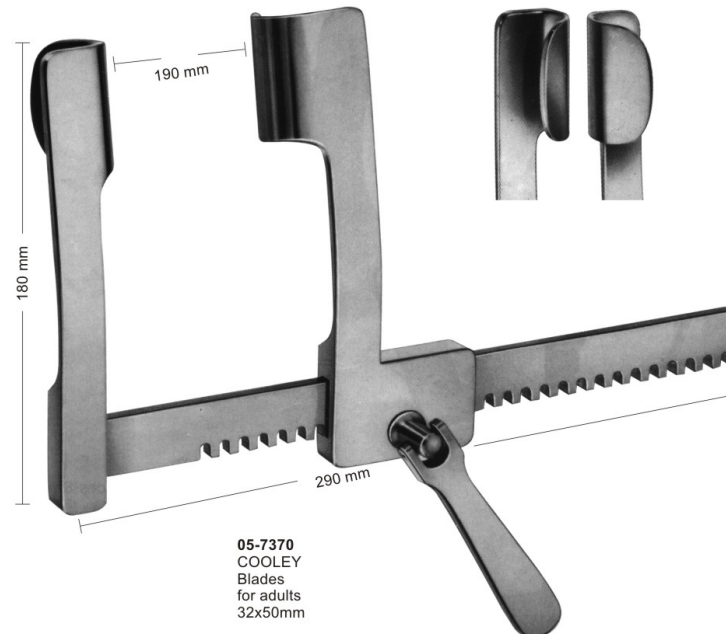
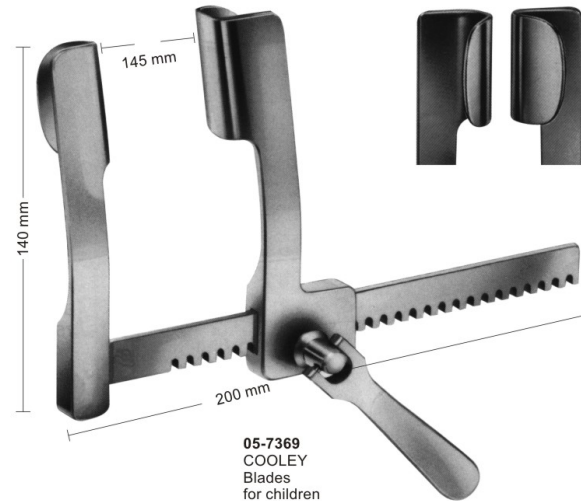

Thoracic Retractors



05-7371
Blades
75x75 mm



05-7373
Blades
42x65 mm

Blades with Ball Snap System
Delivery: in Pairs

- 05-7371 - 05-7373**
Thoracic Retractor (Mercedes-Retractor)
complete consisting of:
05-7371 Retractor only
05-7372 1 Pair of blades 75x75 mm
05-7373 1 Pair of blades 42x65 mm

Rib Spreaders-and Contractors



05-7374
SELLORS
Rib spreader-and contractor
with swivel blades
200 mm



05-7375
BAILEY
150 mm



05-7376
for children

05-7377
for adults

05-7376 - 05-7377
BAILEY
200 mm

Retractors, Lung Spatulas

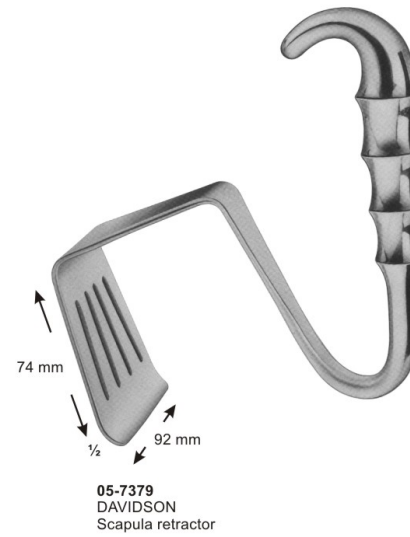
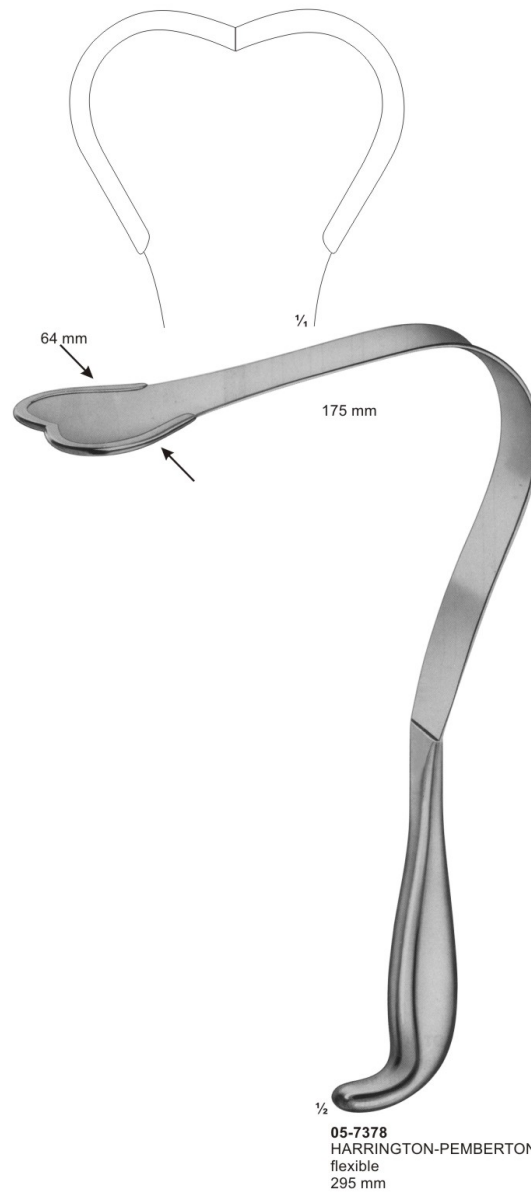

Lung Spatulas, Suction Cannulae

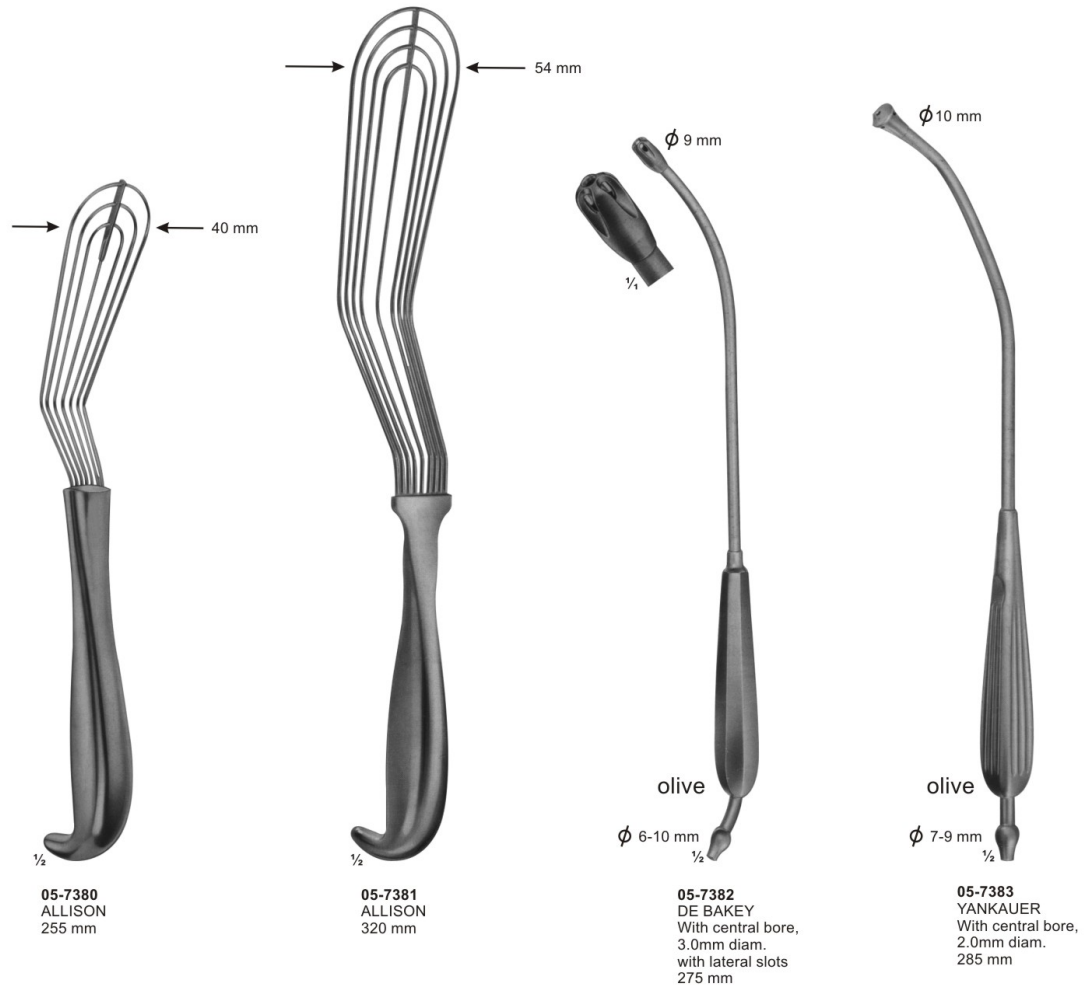

Punches

Angled positions for punchus

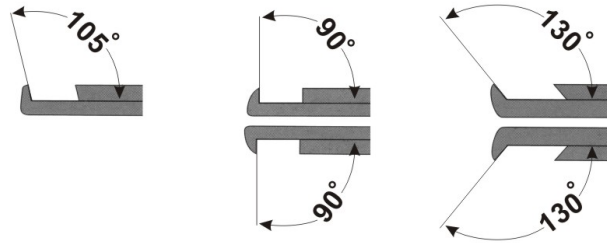

90° upwards cutting

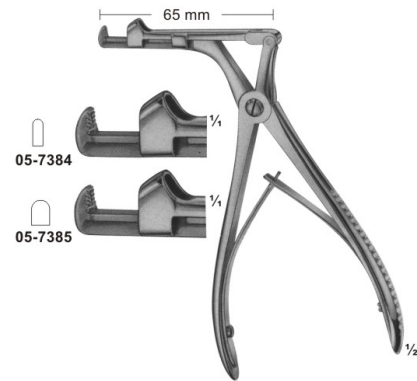

05-7384

05-7385

05-7384 - 05-7385
CITELLI
05-7384 2mm
05-7385 3.5mm

90° upwards cutting

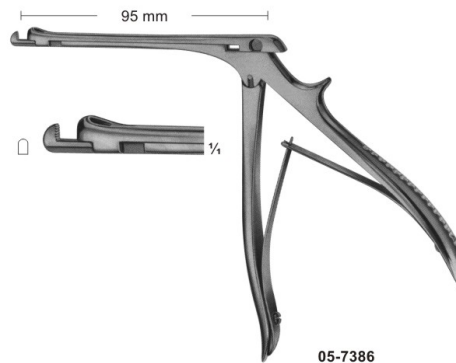

05-7386
CITELLI- BEYER
1,8 mm

Punches

90° upwards cutting

85 mm

05-7387
4 mm



1/4

05-7388
5 mm



1/4

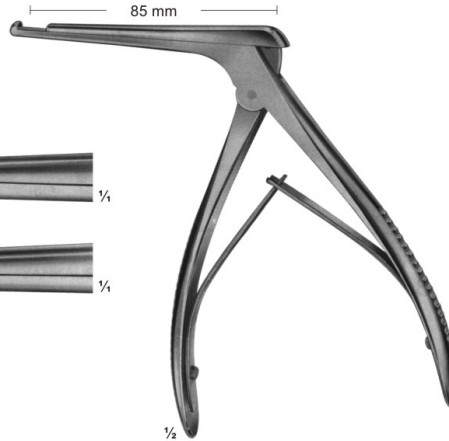

1/2

05-7387 - 05-7388
KERRISON

90° upwards cutting

140 mm

05-7389
3,3 mm



1/4

05-7390
4,0 mm



1/4

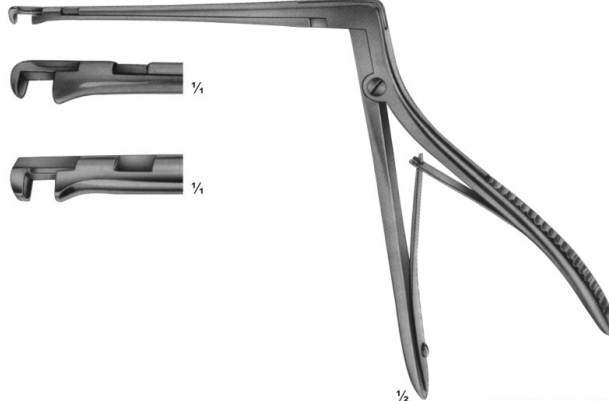

1/2

05-7389 - 05-7390
HAJEK-KOFLER

Punches

130°

upwards cutting

KERRISON-JACOBY

05-7391
1 mm □

FERRIS-SMITH-KERRISON

05-7392
2 mm □

05-7393
3 mm □

05-7394
4 mm □

05-7395
5 mm □

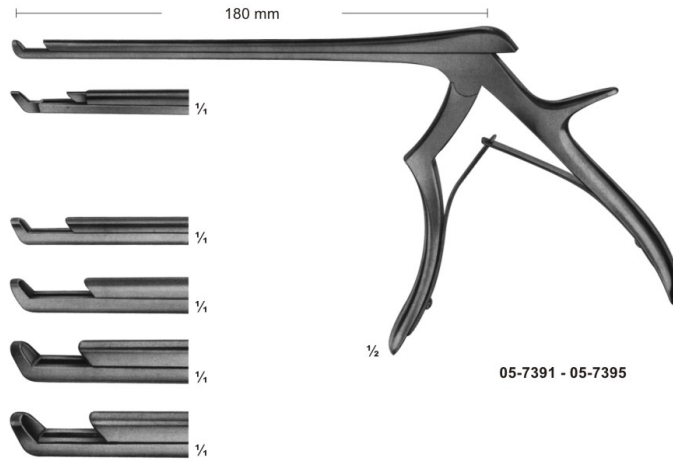

90°

upwards cutting

KERRISON-JACOBY

05-7396
1 mm □

05-7397
2 mm □

FERRIS-SMITH-KERRISON

05-7398
3 mm □

05-7399
4 mm □

05-7400
5 mm □

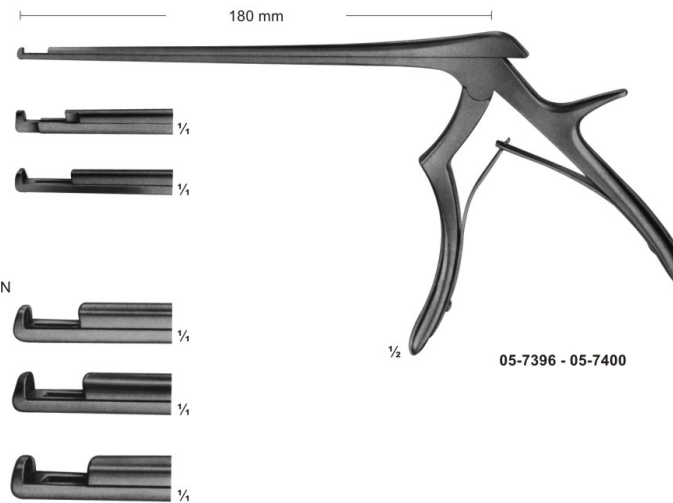

Rongeurs

Angled positions for rongeurs

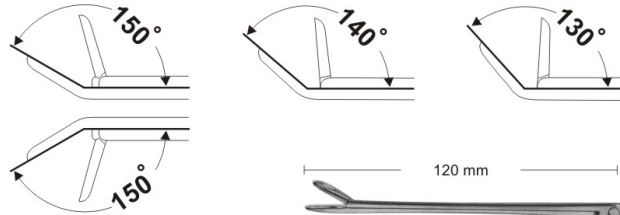

- 05-7401**
3,0 mm
- 05-7402**
3,6 mm
- 05-7403**
4,2 mm
- 05-7404**
4,8 mm
- 05-7405**
5,8 mm

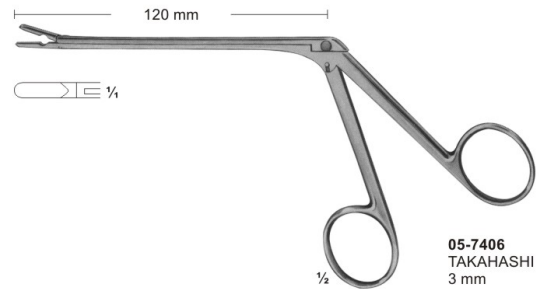
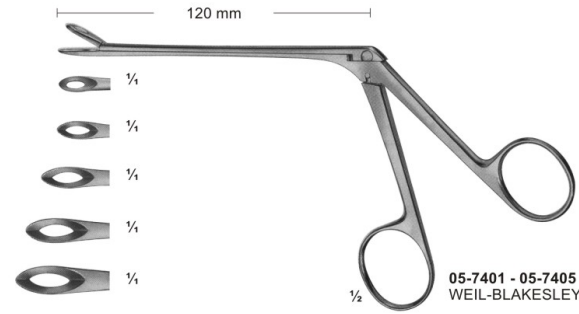

130°

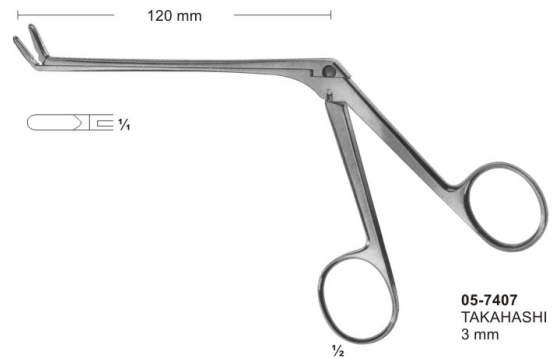

Rongeurs

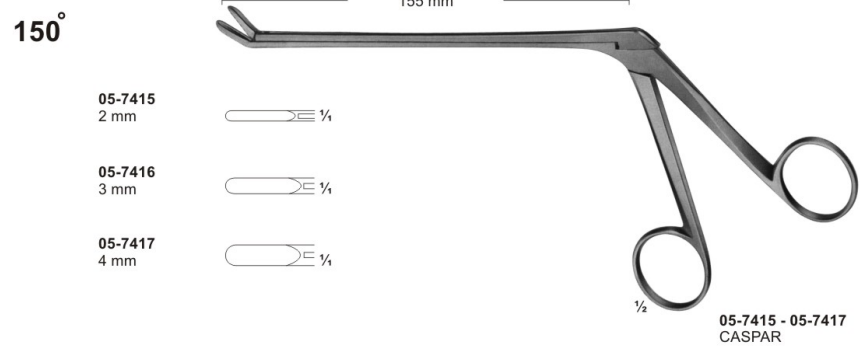
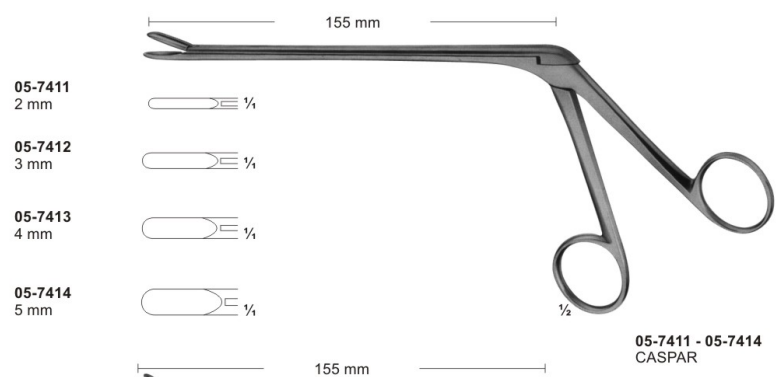
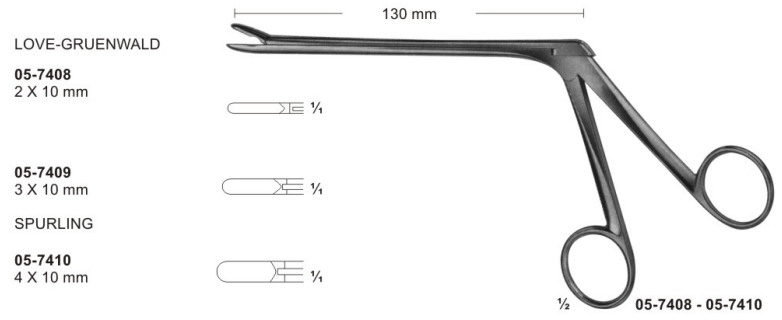

Rongeurs

150°

Lower part of jaws movable

05-7418
2 mm



05-7419
3 mm



05-7420
4 mm

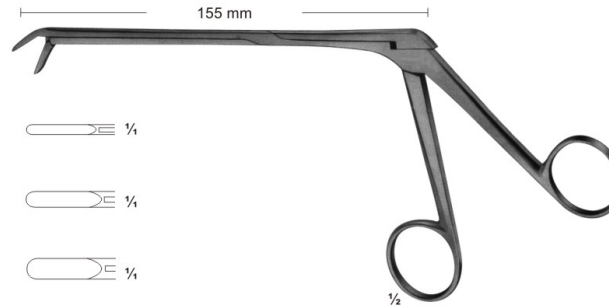

05-7418 - 05-7420
CASPAR

Length of shaft 140 mm	Length of shaft 160 mm	Length of shaft 185 mm	size of jaws
---------------------------	---------------------------	---------------------------	--------------

05-7421

05-7426

05-7431

2 X12 mm



05-7422

05-7427

05-7432

3 X12 mm



05-7423

05-7428

05-7433

4 X14 mm



05-7424

05-7429

05-7434

5 X14 mm



05-7425

05-7430

05-7435

6 X16 mm

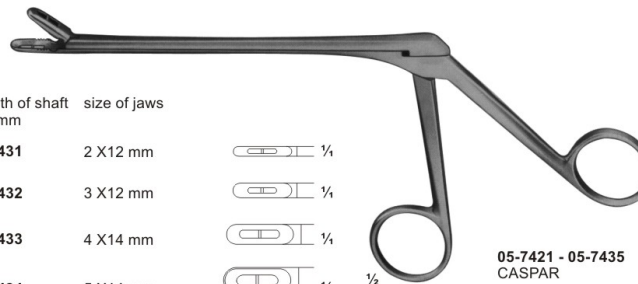

05-7421 - 05-7435
CASPAR

150°

Length of shaft 140 mm	Length of shaft 160 mm	Length of shaft 185 mm	size of jaws
---------------------------	---------------------------	---------------------------	--------------

05-7436

05-7439

05-7442

3 X12 mm



05-7437

05-7440

05-7443

4 X14 mm



05-7438

05-7441

05-7444

5 X14 mm

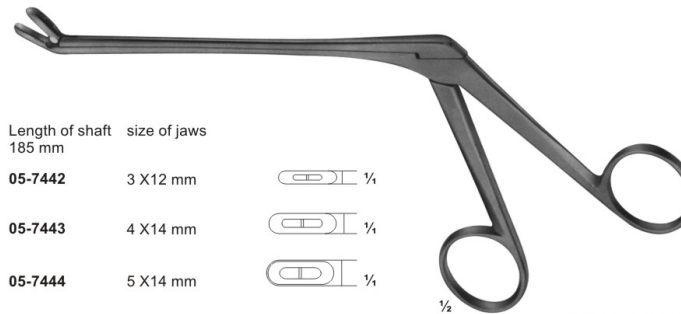

05-7436 - 05-7444
CASPAR

Rongeurs

150°

Lower part of jaw movable

Length of shaft 140 mm	Length of shaft 160 mm	Length of shaft 185 mm	size of jaws
05-7445	05-7447	05-7449	3 X12 mm
05-7446	05-7448	05-7450	4 X14 mm

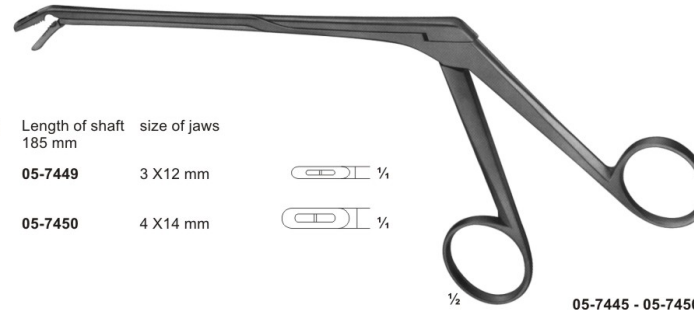

05-7445 - 05-7450
CASPAR

05-7451
2 X 10 mm
CUSHING



05-7452
3 X 10 mm
LOVE-GRUENWALD



05-7453
4 X 10 mm
SPURLING

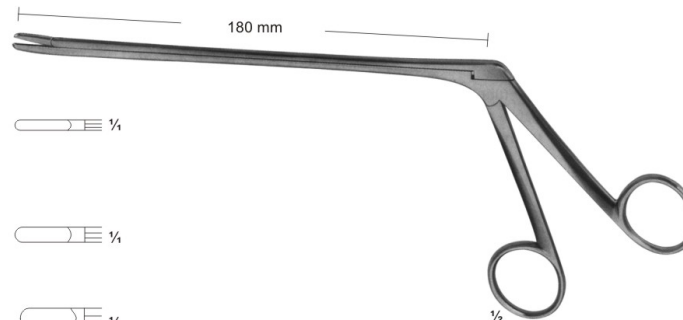

05-7451 - 05-7453

150°

05-7454
3 X 10 mm
LOVE-GRUENWALD



05-7455
4 X 10 mm
SPURLING

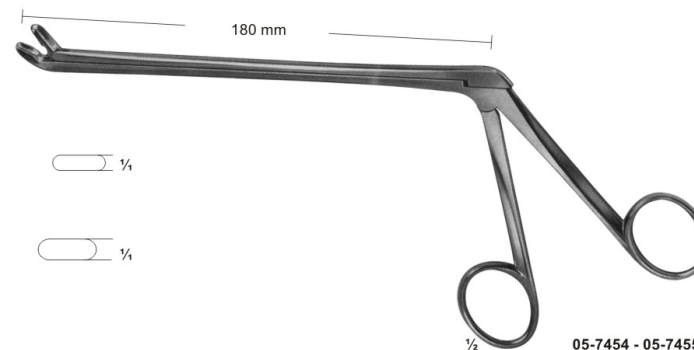

05-7454 - 05-7455

Rongeurs

150°

Upper part of jaw
movable

05-7456
3 X 10 mm
LOVE-GRUENWALD

05-7457
4 X 10 mm
SPURLING

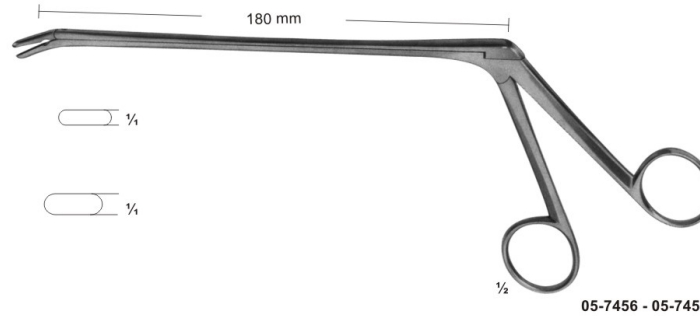

05-7458
∅ 7 mm

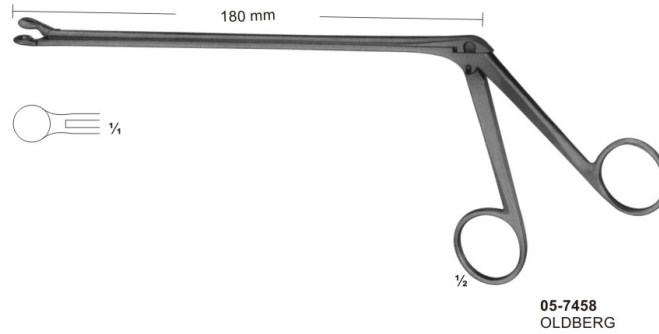

05-7459
YASARGIL
∅ 2,2 mm

05-7460
YASARGIL
∅ 3,5 mm

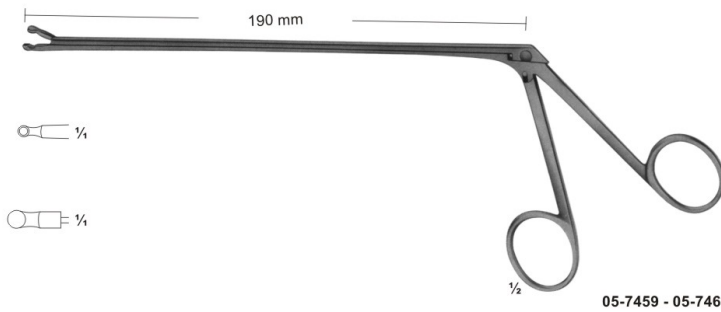

Rongeurs

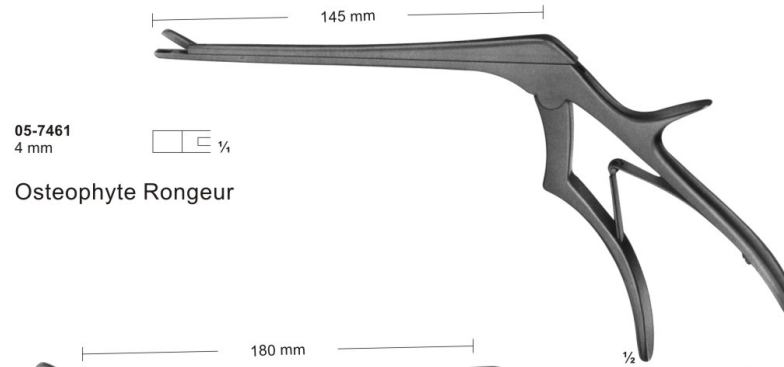

05-7461
4 mm



Osteophyte Rongeur

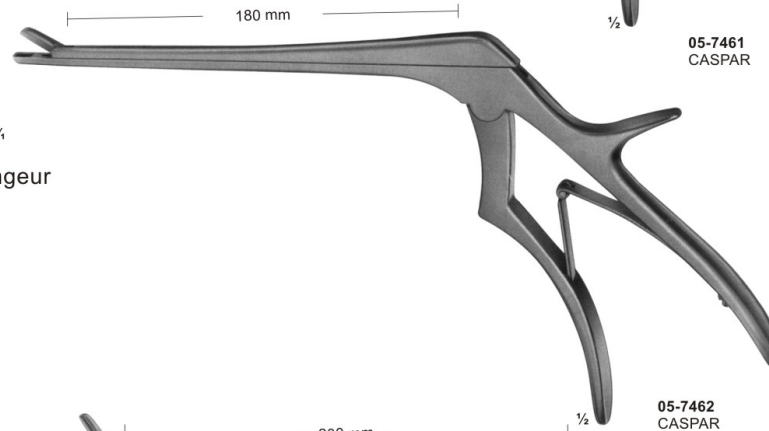

05-7462
4 mm



Osteophyte Rongeur

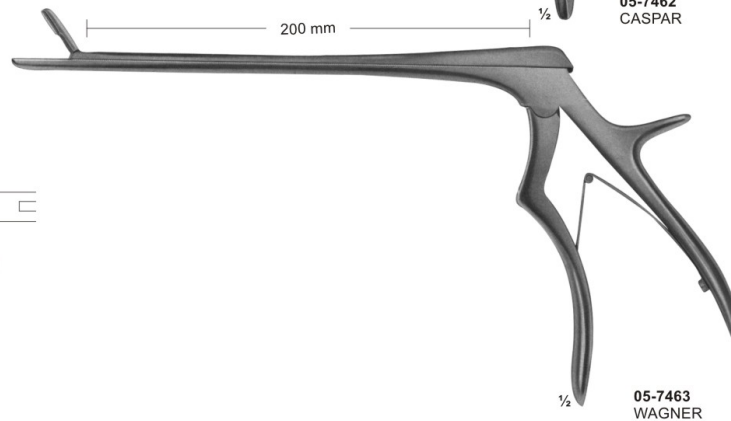

05-7463
5,5 mm



Very Heavy Pattern

05-7461
CASPAR

05-7462
CASPAR

05-7463
WAGNER

Amputation and Resection Knives

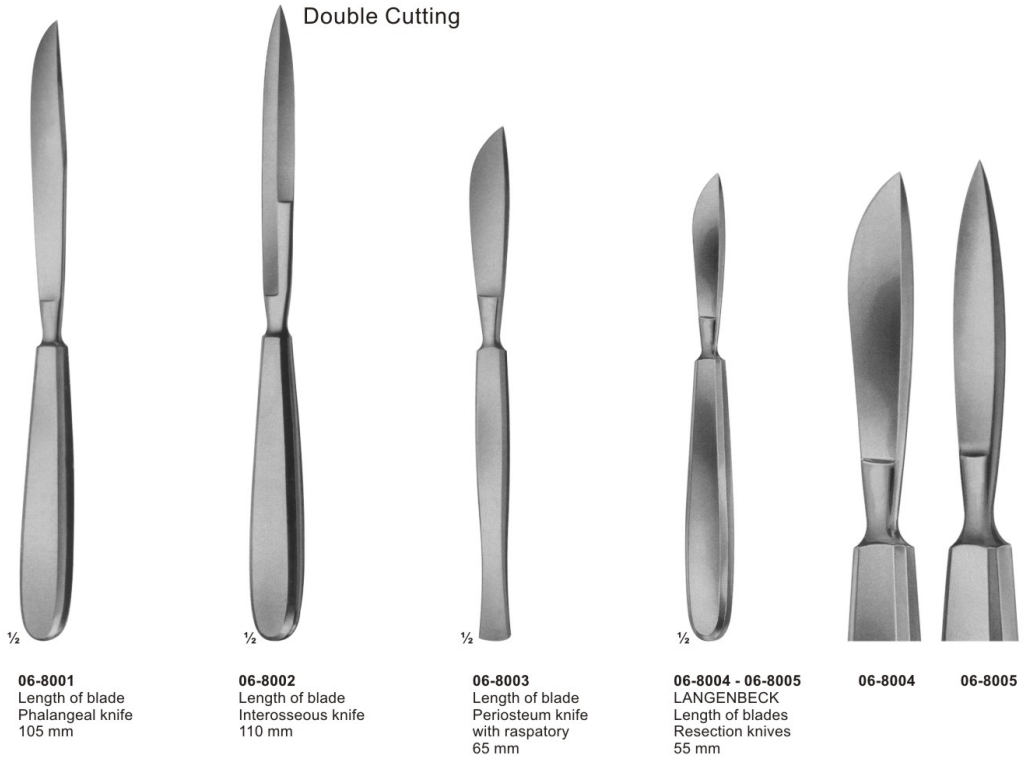

Amputation Retractors

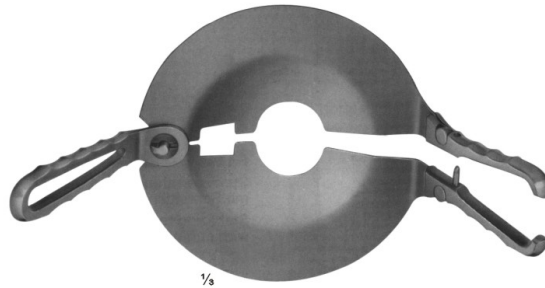

06-8006
PERCY
removeable handles

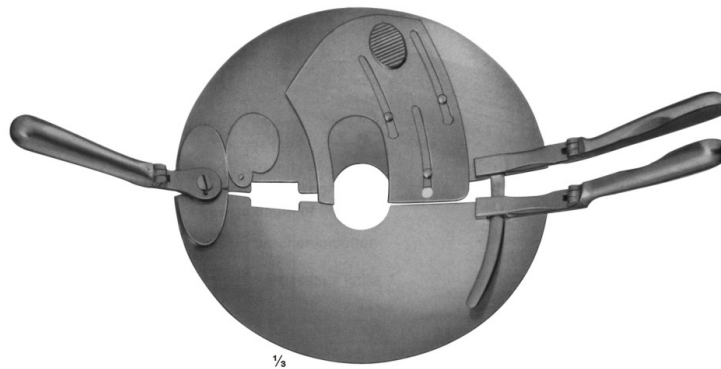

06-8007
PERCY
reversible handles

Amputation Saws



06-8008
CHARRIERE
Length of blade
215 mm
complete with one saw
blade each(**06-8009** and **06-8010**)
350 mm

Spare saw blades, carbon steel
06-8009 12 mm
06-8010 20 mm

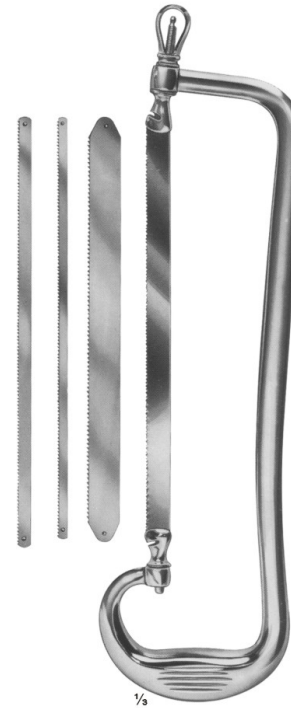

06-8011
RUST
Length of blade
235 mm
complete with one saw
blade each(**06-8013**, **06-8014**
and 2 saw blades **06-8015**)
390 mm
06-8012 Bow only

Spare saw blades, carbon steel
06-8013 6 mm
06-8014 8 mm
06-8015 12 mm
06-8016 20 mm

Amputation Saws

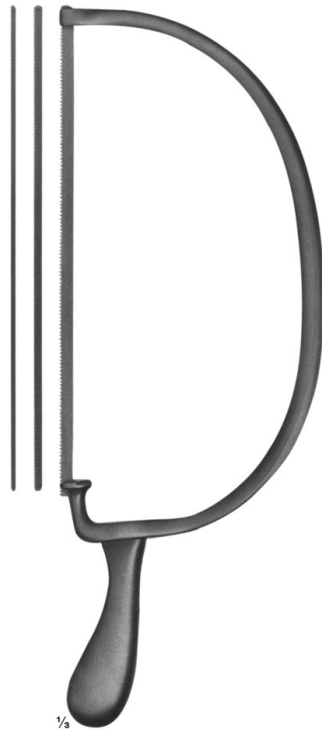

06-8017
BIER
Length of blade
270 mm
complete with one saw
blade each(06-8018, 06-8019 and 06-8020)
420 mm

Spare saw blades, carbon steel
06-8018 4 mm
06-8019 6 mm
06-8020 8 mm

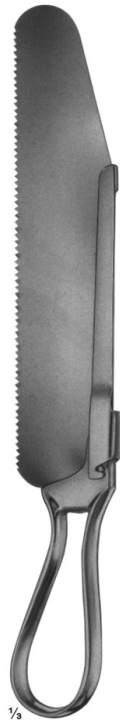

06-8021
CHARRIERE
Length of blade
180 mm
Spare saw blade,
carbon steel (06-8022)
270 mm

06-8023
CHARRIERE
Length of blade
240 mm
Spare saw blade,
carbon steel(06-8024)
340 mm

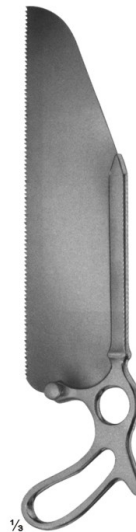

06-8025
SATTERLEE
Length of blade
200 mm
Spare saw blade,
carbon steel(06-8026)
200 mm



06-8027
LANGENBECK
Length of blade
115 mm
Metacarpal saw
235 mm

Wire Saws And Conductor

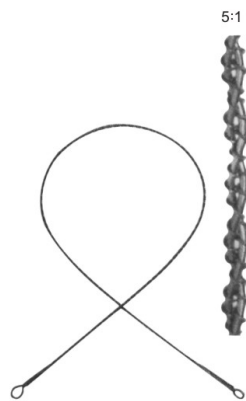

06-8028 - 06-8031
OLIVECRONA
06-8028 300 mm
06-8029 400 mm
06-8030 500 mm
06-8031 700 mm

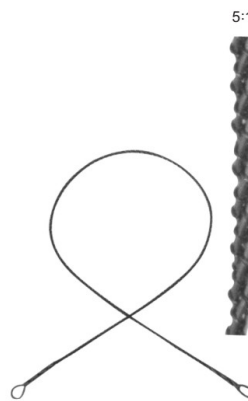

06-8032 - 06-8035
GIGLI
06-8032 300 mm
06-8033 400 mm
06-8034 500 mm
fine, 6 wires twisted
06-8035 500mm
coarse, 4 wires twisted



06-8036
GIGLI
Handle



06-8037
LEBSCHE
Conductor for
wire saws, malleable
250 mm

Elevators and Bone Levers



Bone Levers

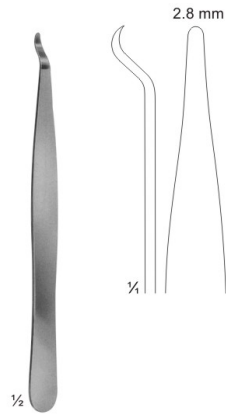

06-8046
140mm

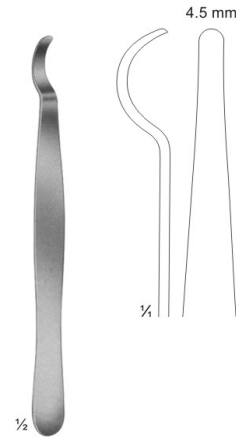

06-8047
150mm

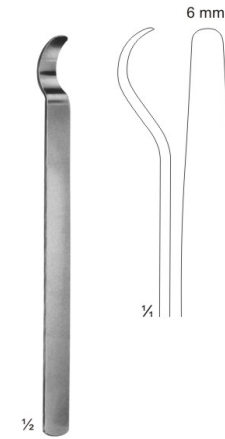

06-8048
150mm

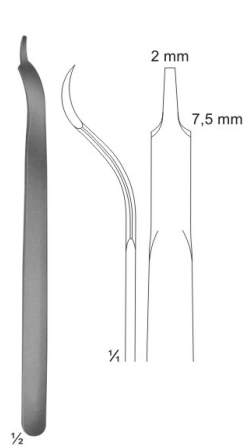

06-8049
BUCK-GRAMCKO
150mm

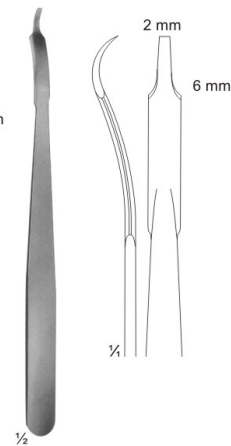

06-8050
160mm

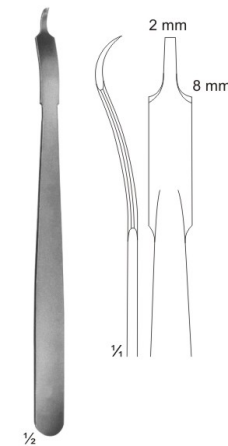

06-8051
160mm

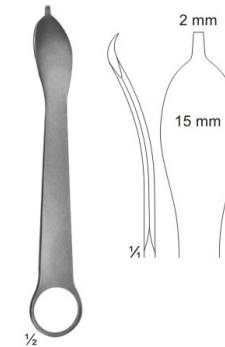

06-8052
125mm

Bone Levers

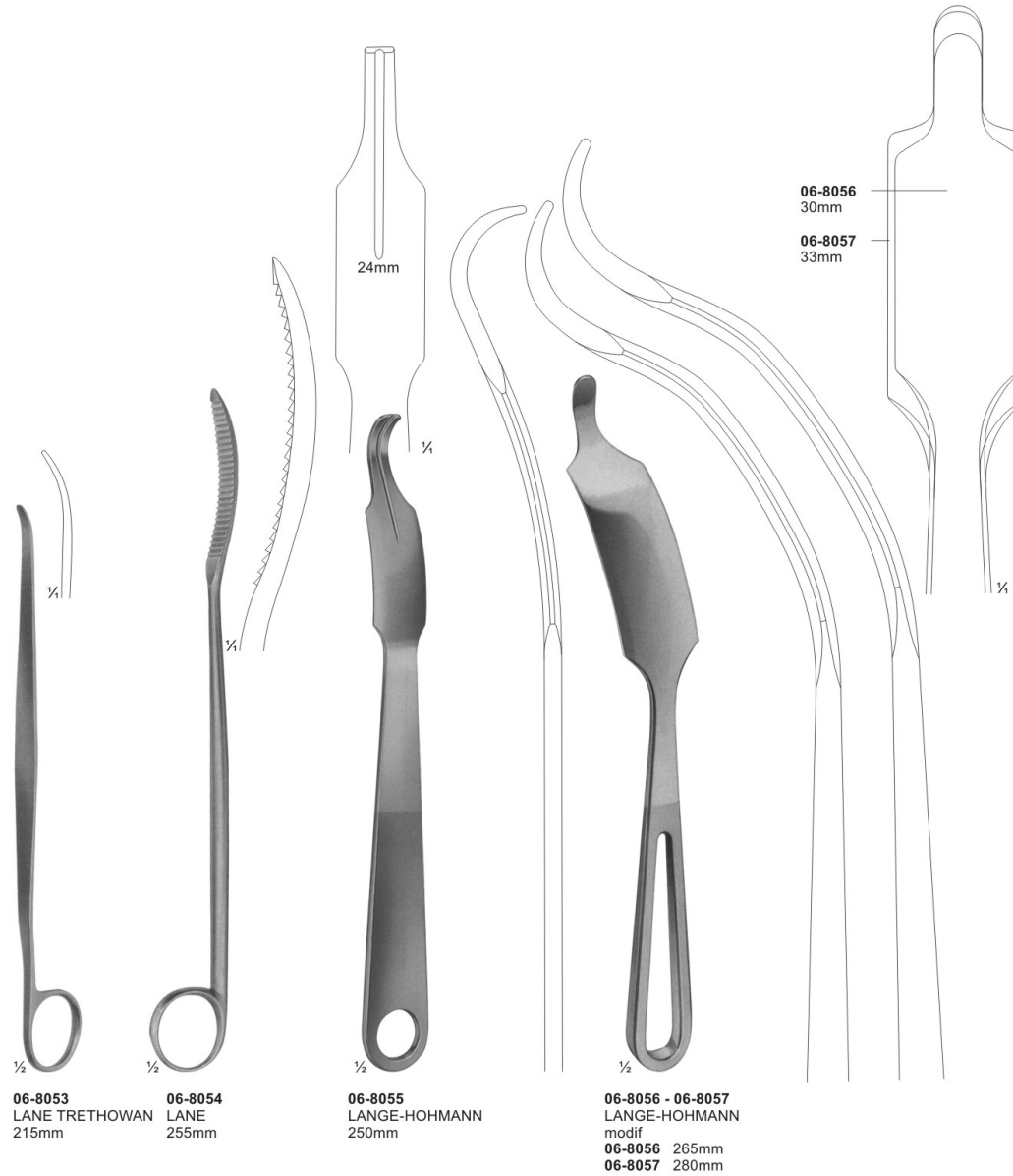

Bone Levers

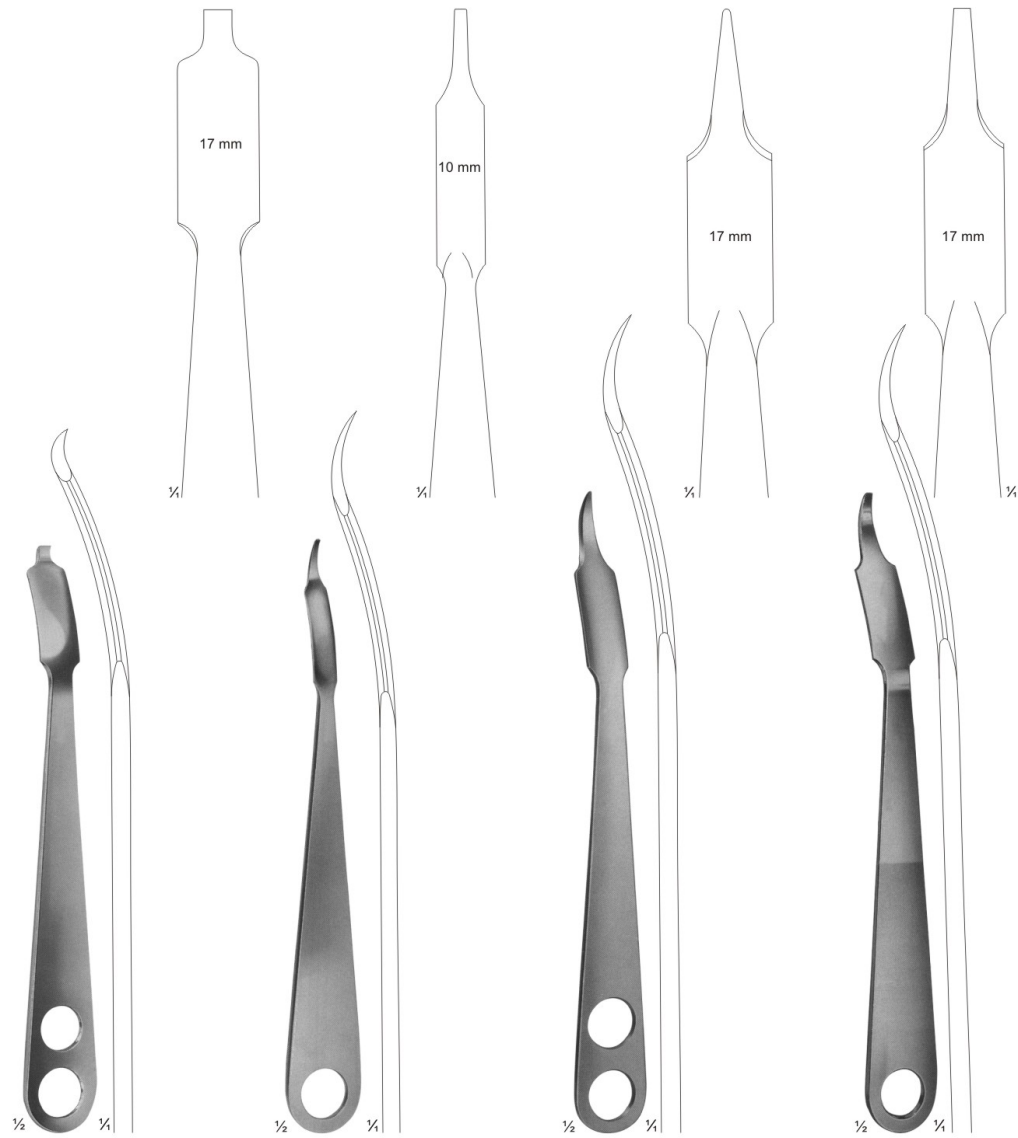

06-8058
WAGNER
220 mm

06-8059
220 mm

06-8060
240 mm

06-8061
240 mm

Bone Levers

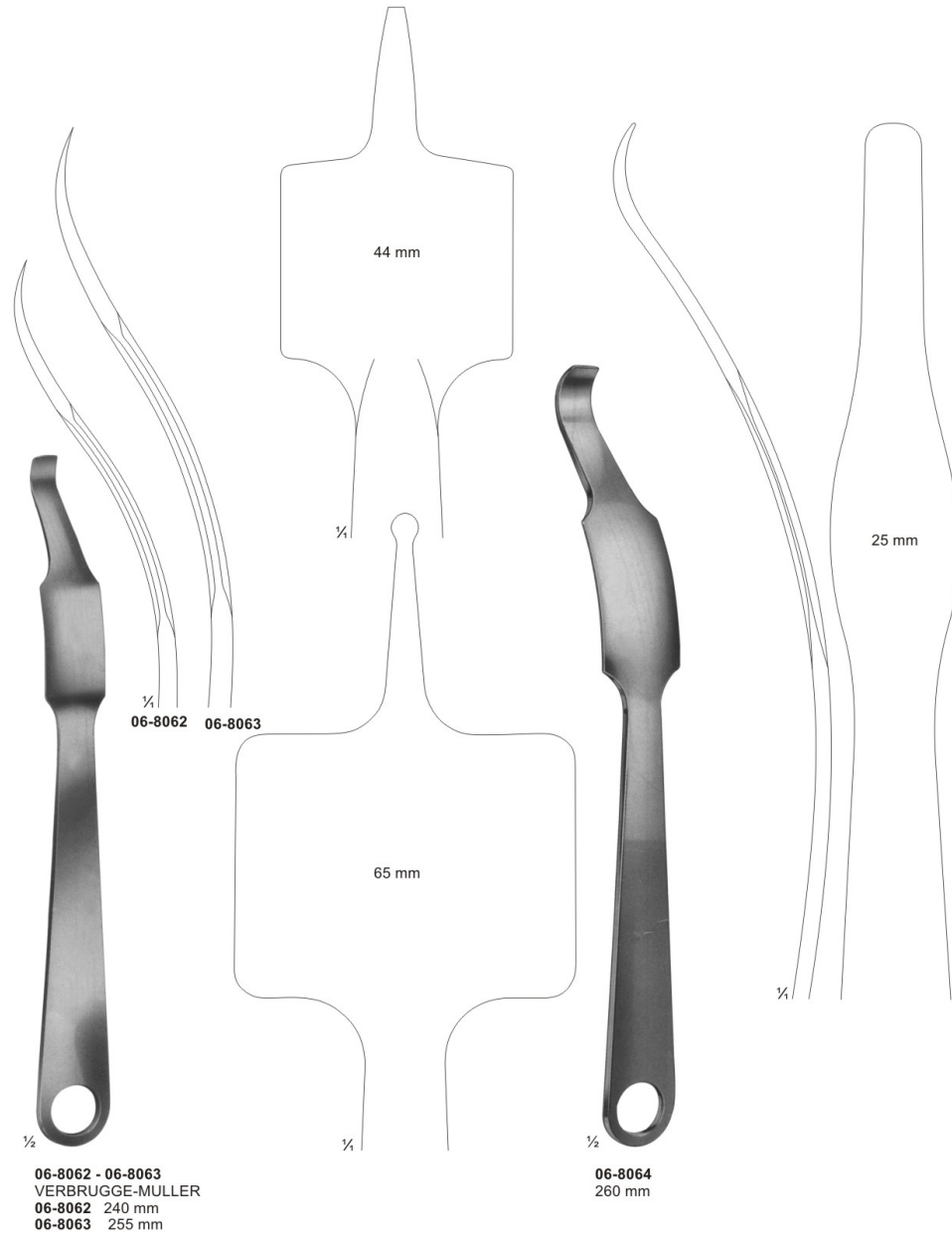

Bone Levers

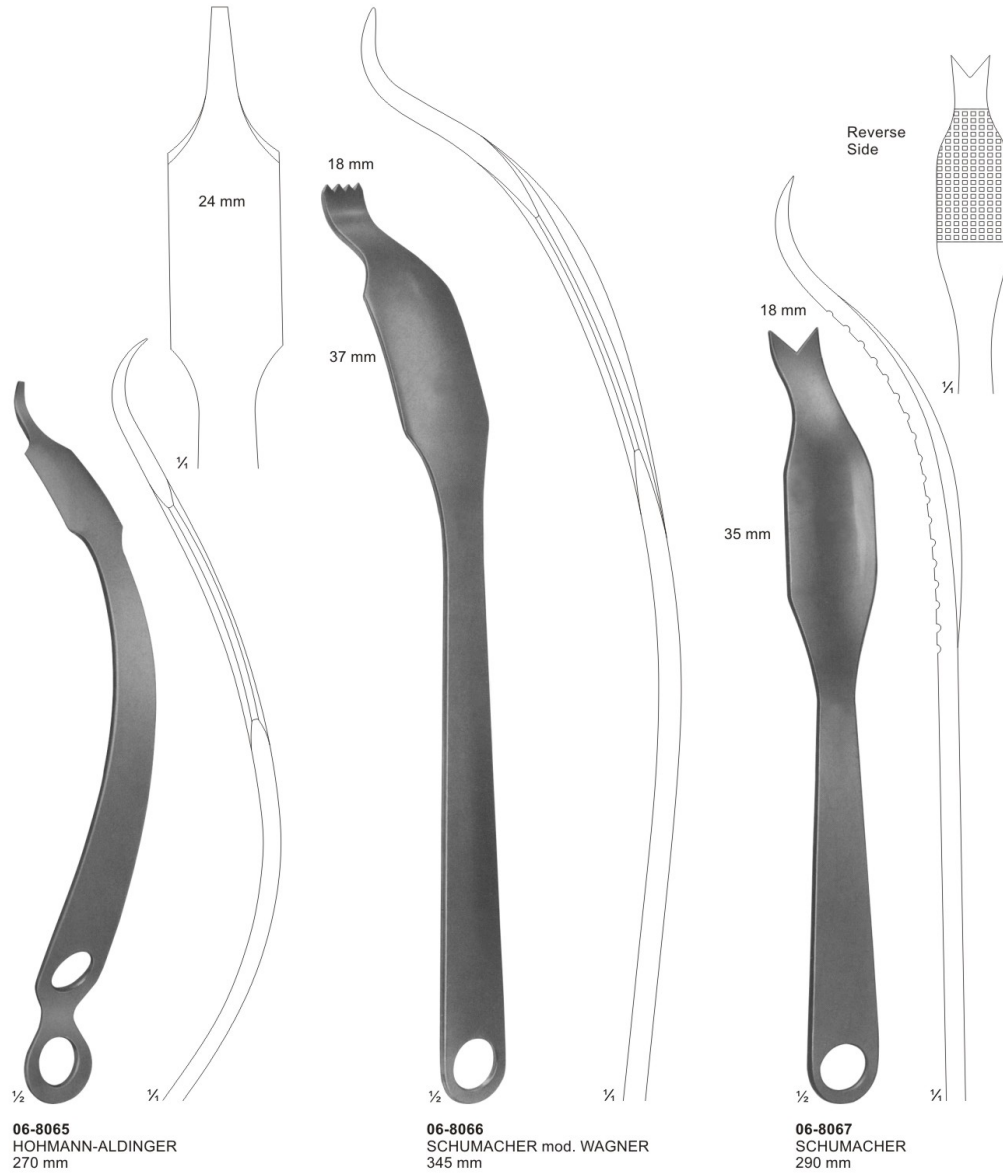

Special Bone Levers

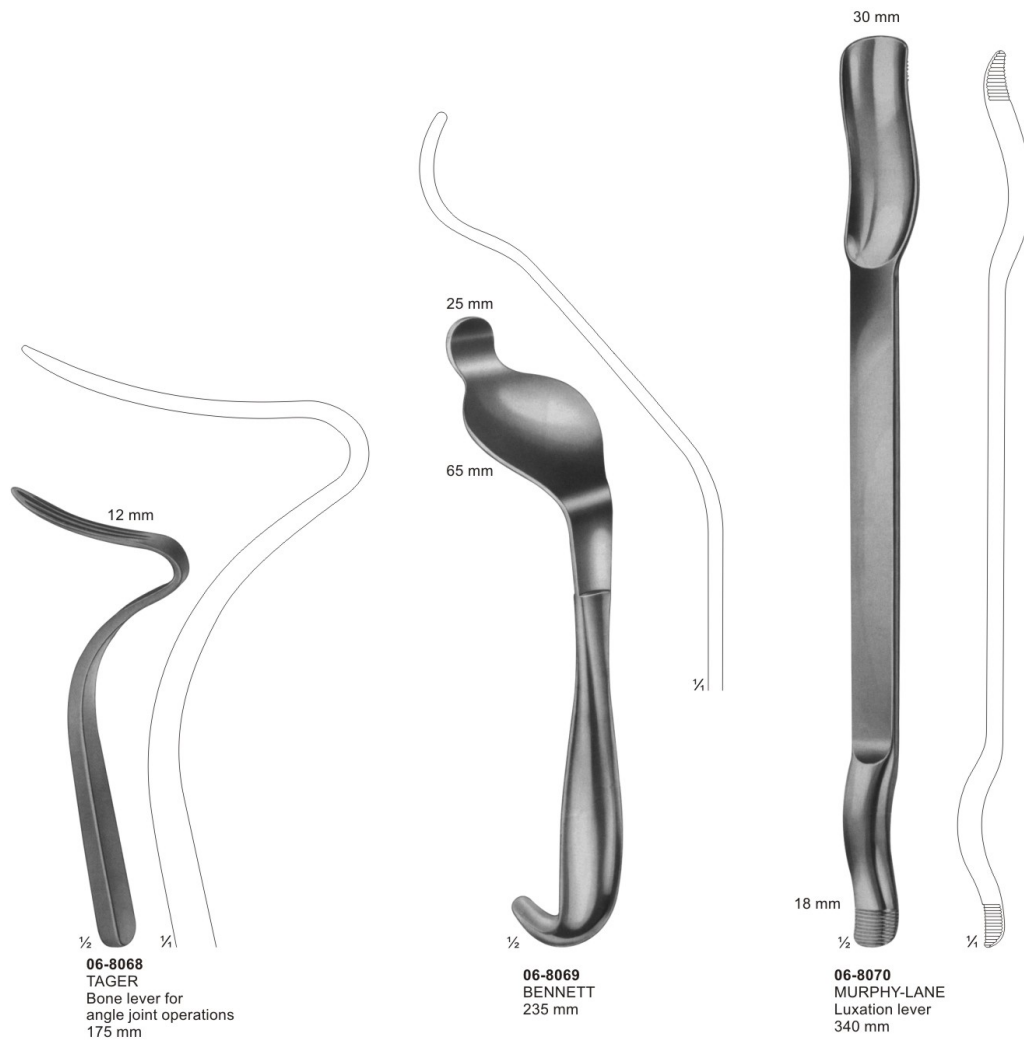

Raspatories

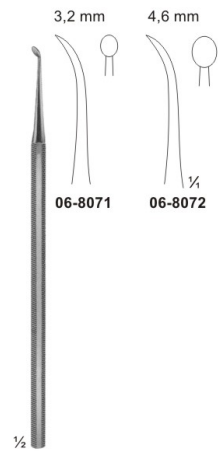

06-8071 - 06-8072
PARTSCH
150 mm

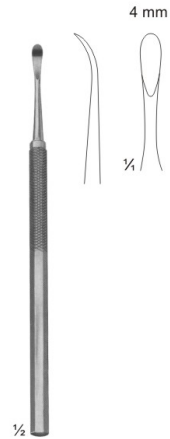

06-8073
PARTSCH mod. LANGE
145 mm

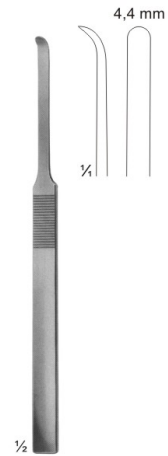

06-8074
MC KENTY
155 mm

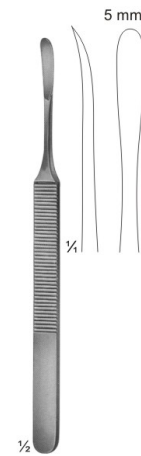

06-8075
KOENIG
155 mm

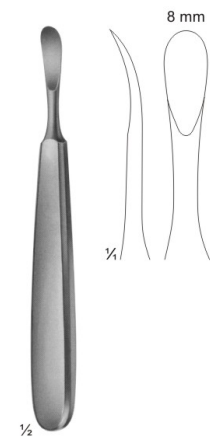

06-8076
TRELAT
150 mm

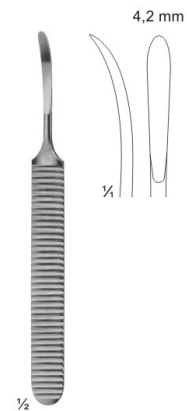

06-8077
WILLIGER
140 mm

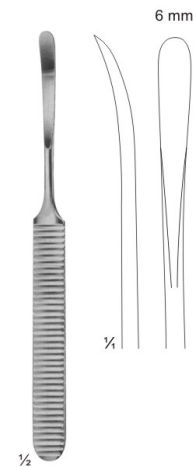

06-8078
WILLIGER
160 mm

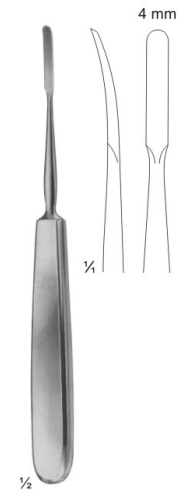

06-8079
JOSEPH
170 mm

Raspatories

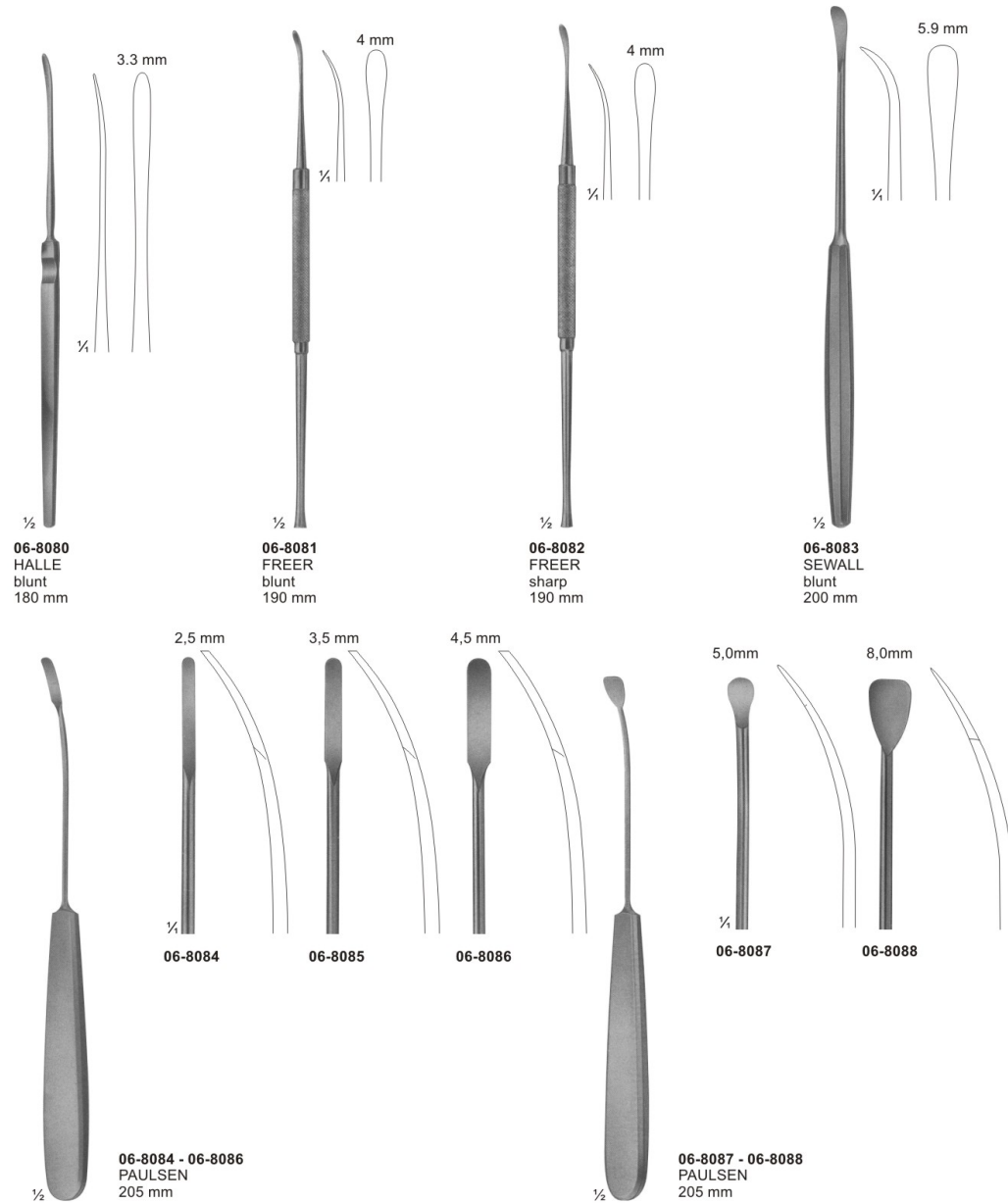

Raspatories

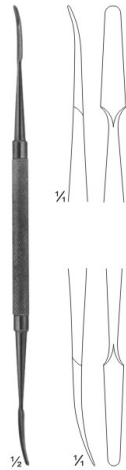

06-8089
KILLIAN
sharp/blunt
185 mm

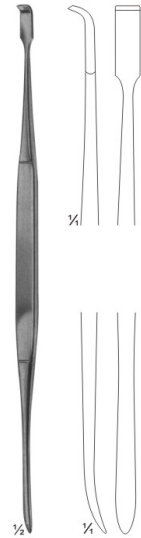

06-8090
HOWARTH
sharp/blunt
215 mm

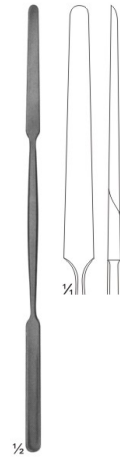

06-8091
KILLIAN
sharp/blunt
185 mm

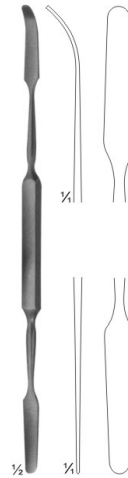

06-8092
MAC DONALD
blunt/blunt
185 mm

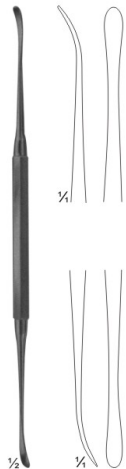

06-8093
FREER
sharp/blunt
185 mm

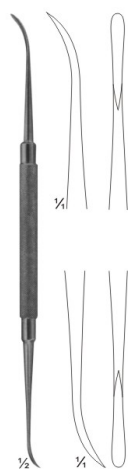

06-8094
FREER-YASARGIL
sharp/sharp
185 mm

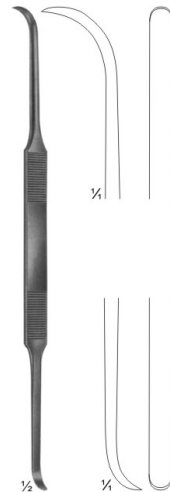

06-8095
COTTLE
sharp/sharp
200 mm

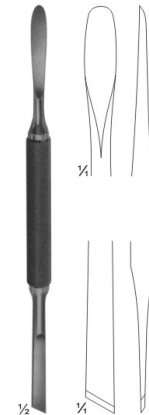

06-8096
MEAD
sharp/sharp
165 mm

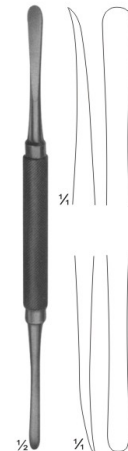

06-8097
MOLT
sharp/sharp
180 mm

Raspatories

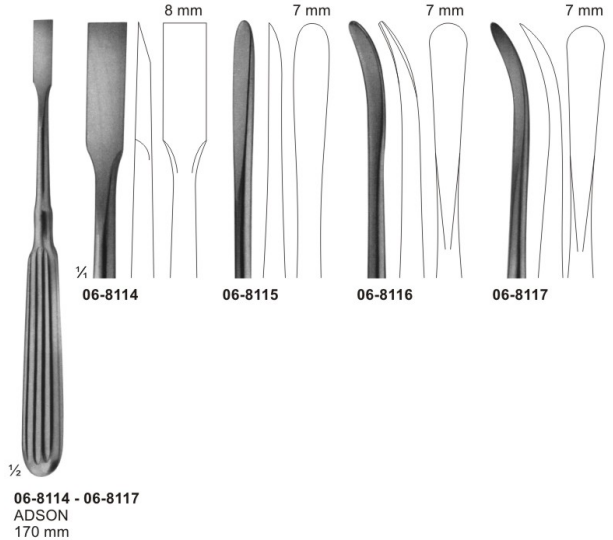
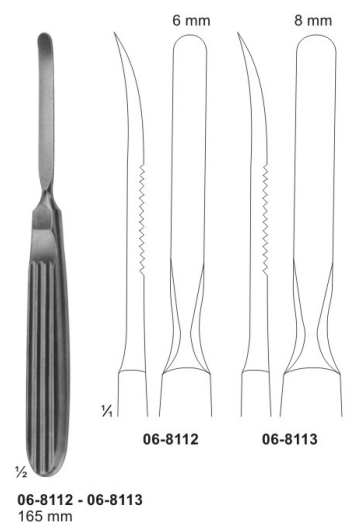
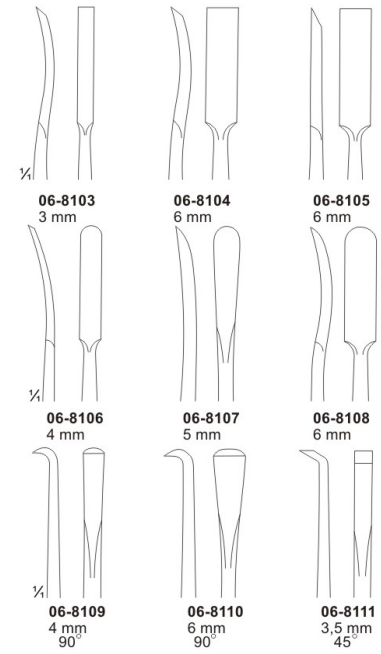
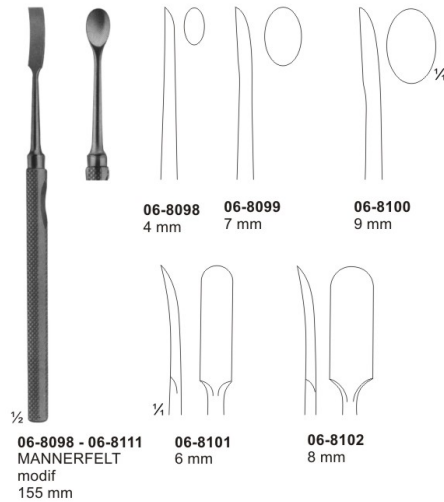

Raspatories

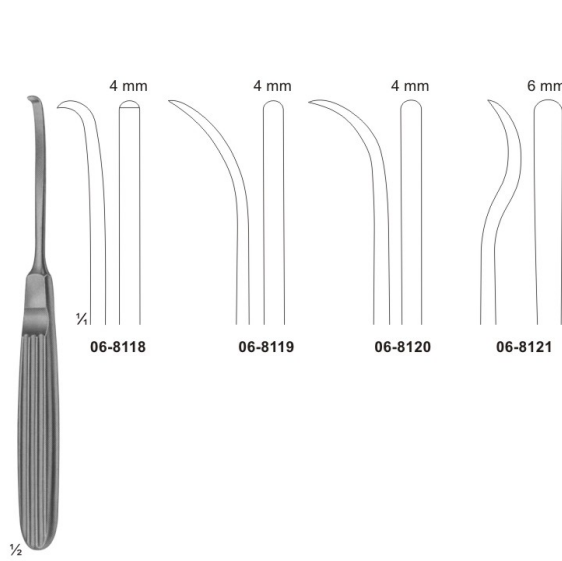

06-8118 - 06-8121
MUEHLING
170 mm

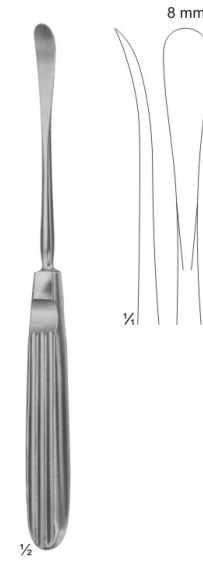

06-8122
COTTLE
195 mm

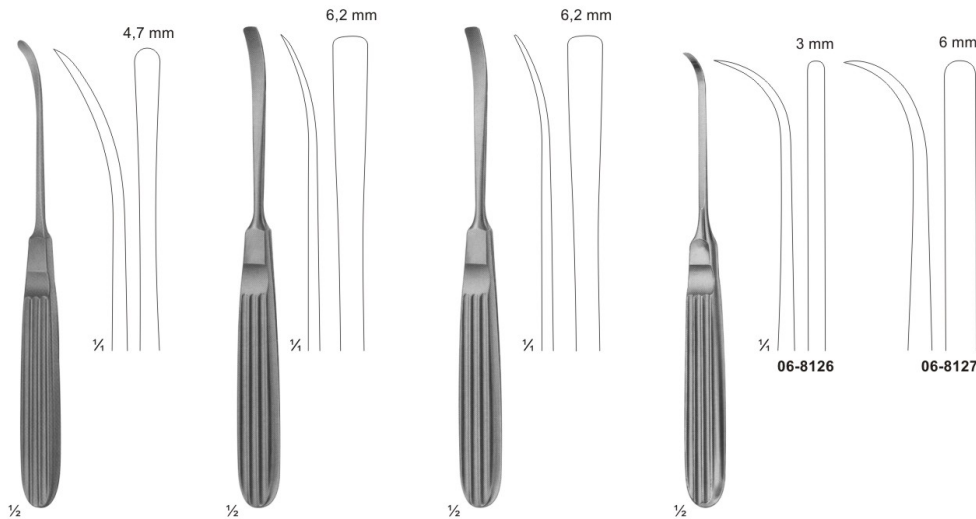

06-8123
LANDOLT
175 mm

06-8124
CASPAR
180 mm

06-8125
CASPAR
180 mm

06-8126 - 06-8127
170 mm

Raspatories

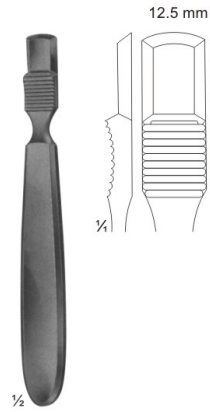

06-8128
FARABEU
140 mm

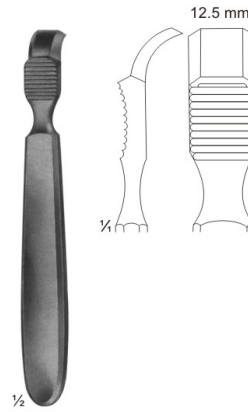

06-8129
FARABEU
140 mm

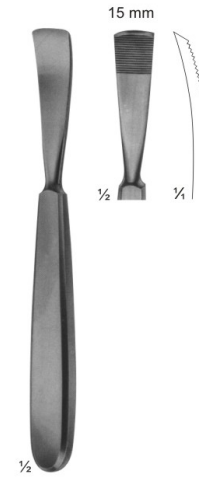

06-8130
JANSEN
165 mm

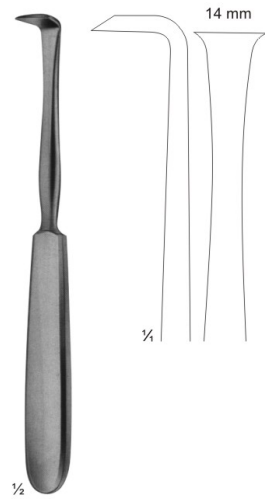

06-8131
LANGENBECK
180 mm

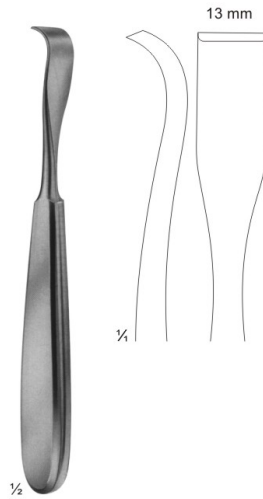

06-8132
SCHNEIDER
175 mm

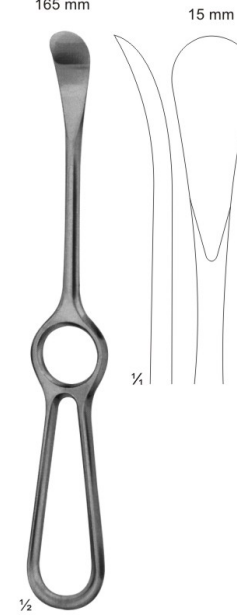

06-8133
SEDILLOT
215 mm

Raspatories

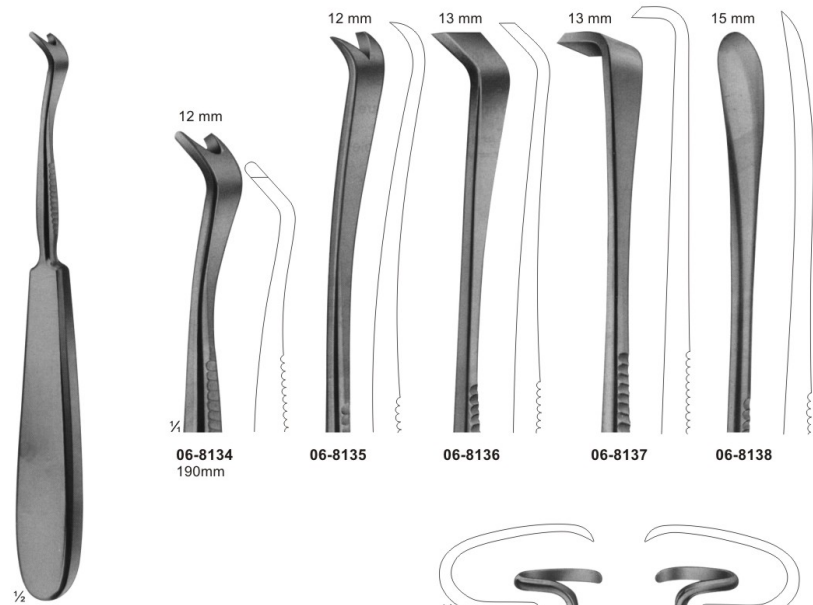

06-8134
190mm

06-8135

06-8136

06-8137

06-8138

06-8134 - 06-8138
SEMB
230 mm



06-8143

06-8144



06-8139

06-8140

06-8141

06-8142

06-8139 - 06-8140
DOYEN for children
06-8141 - 06-8142
for adults 175 mm

06-8143 - 06-8144
DOYEN
240 mm

Raspatories with HARTPRESS-handle

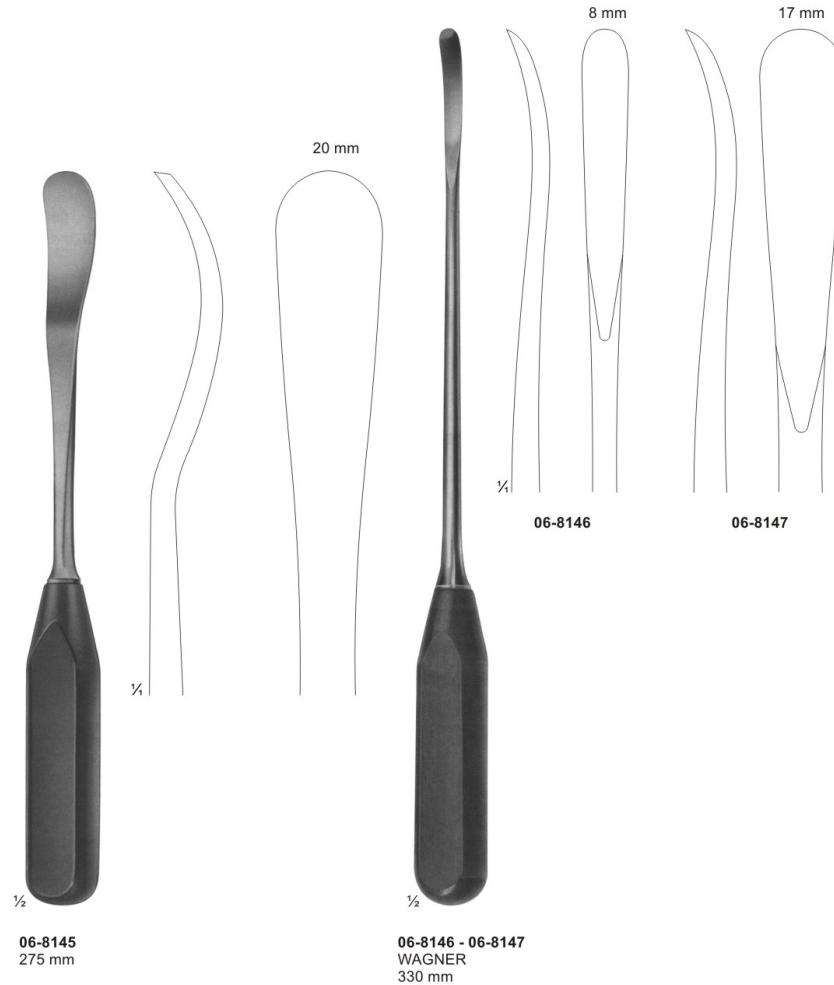

Bone File and Rasps



06-8148
JOSEPH
fine, chequered

06-8149
coarse, chequered
165 mm



06-8152
MALTZ
down stroke
180 mm



06-8153
AUFRICHT
up stroke

06-8154
down stroke
220 mm

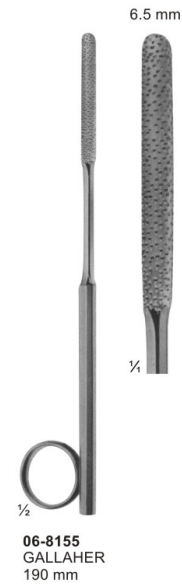
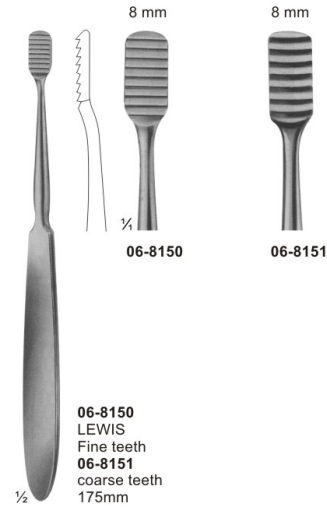
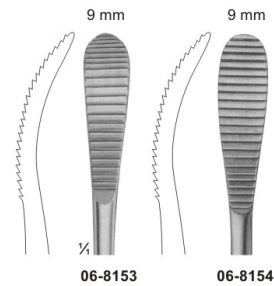

Bone File and Rasps, Durogrip Rasps

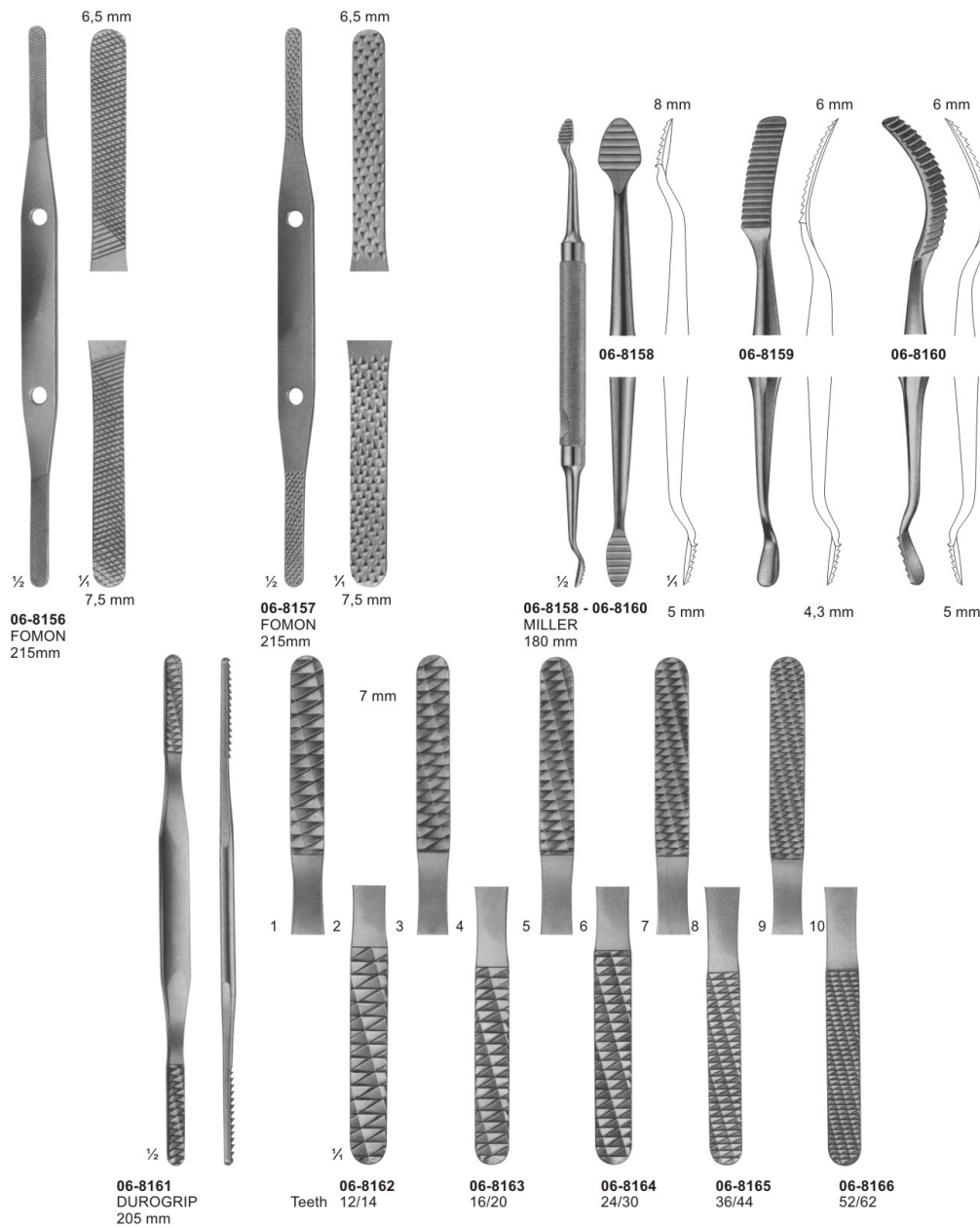

Bone File and Rasps

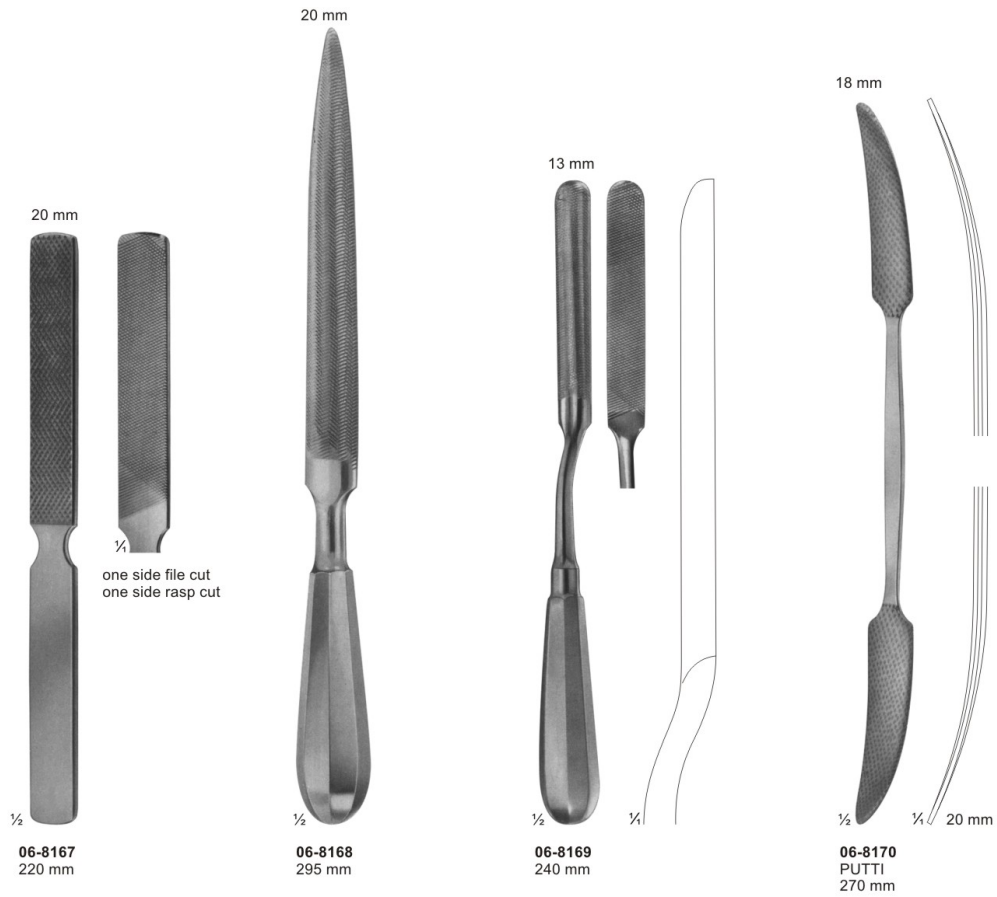

Bone Currettes



06-8171
JACOBSON
140 mm



06-8172
MARTINI
140 mm

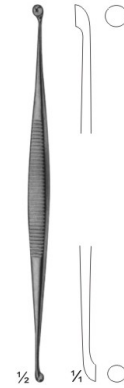

06-8173
MARTINI
140 mm



06-8174
WILLIGER
145 mm



06-8175
JANSEN
160 mm



06-8176
BARTH
180 mm

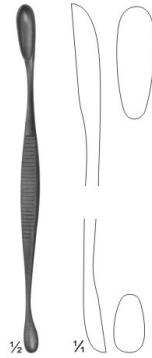

06-8177
VOLKMANN
130 mm

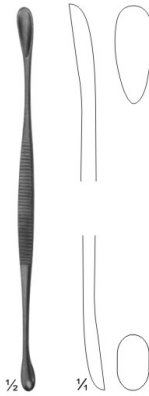

06-8178
VOLKMANN
145 mm

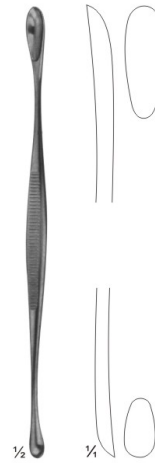

06-8179
VOLKMANN
170 mm

Bone Currettes



06-8180
JANSEN
160 mm



06-8181
HEMINGWAY
170 mm

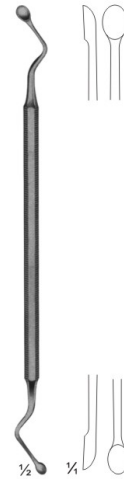

06-8182
HEMINGWAY
175 mm

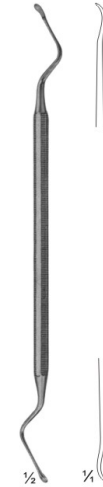

06-8183
LUCAS
180 mm

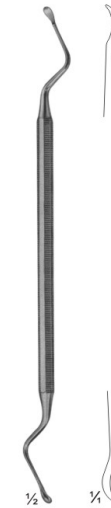

06-8184
LUCAS
185 mm



06-8185
06-8186

06-8187
06-8188

06-8185 - 06-8187
KERPEL
145 mm

06-8186 - 06-8188
KERPEL
145 mm

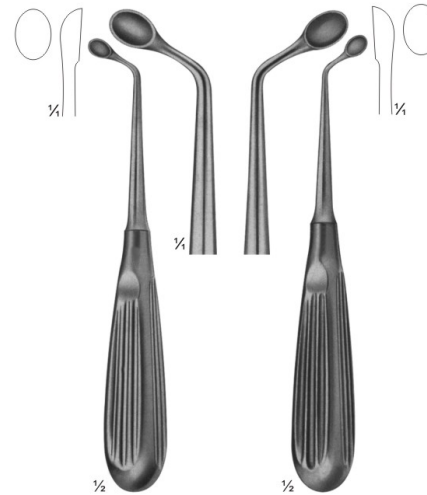

06-8189
UFFENORDE
170 mm

06-8190
UFFENORDE
170 mm

Bone Currettes



½

06-8191 - 06-8197
BRUNS
165 mm

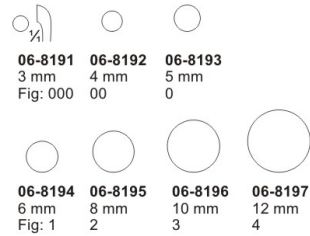

½

06-8198 - 06-8204
SCHEDE
170 mm

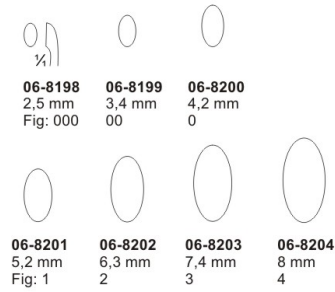

½

06-8205 - 06-8214
VOLKMANN
170 mm

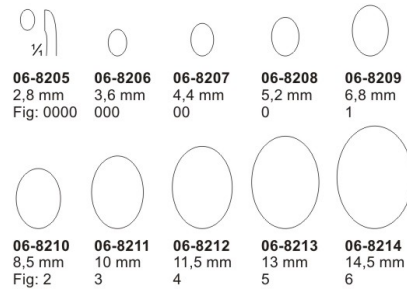

½

06-8215 - 06-8216
WILLIGER
170 mm

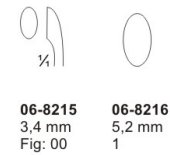

Bone Currettes

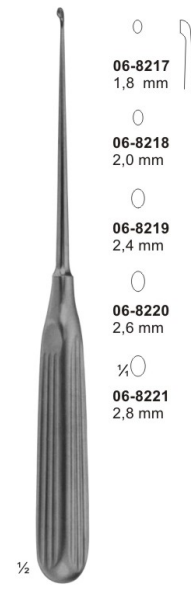

06-8217
1,8 mm

06-8218
2,0 mm

06-8219
2,4 mm

06-8220
2,6 mm

06-8221
2,8 mm

½

06-8217 - 06-8221
LEMPERT
215 mm

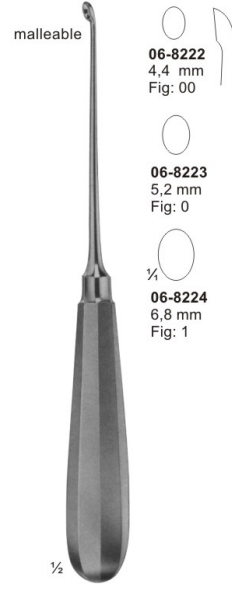

malleable

06-8222
4,4 mm
Fig: 00

06-8223
5,2 mm
Fig: 0

06-8224
6,8 mm
Fig: 1

¼

½

06-8222 - 06-8224
HALLE
215 mm

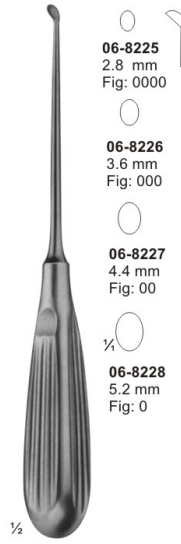

06-8225
2,8 mm
Fig: 0000

06-8226
3,6 mm
Fig: 000

06-8227
4,4 mm
Fig: 00

06-8228
5,2 mm
Fig: 0

½

06-8225 - 06-8228
DAUBENSPECK
200 mm



06-8229
3,6 mm
Fig: 000

06-8230
4,4 mm
Fig: 00

06-8231
5,2 mm
Fig: 0

06-8232
6,8 mm
Fig: 1

½

06-8229 - 06-8232
250 mm



06-8233
3,6 mm
Fig: 000

06-8234
4,4 mm
Fig: 00

06-8235
5,2 mm
Fig: 0

06-8236
6,8 mm
Fig: 1

½

06-8233 - 06-8236
250 mm



06-8237
3 mm

06-8238
4 mm

06-8239
5 mm

½

06-8237 - 06-8239
BUSHE 250 mm

Bone Currettes

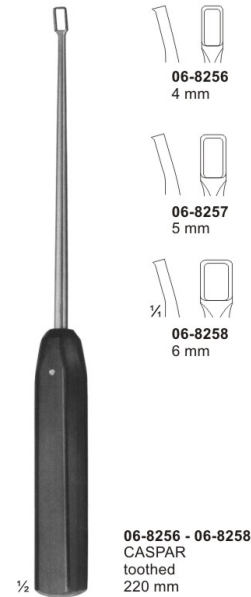
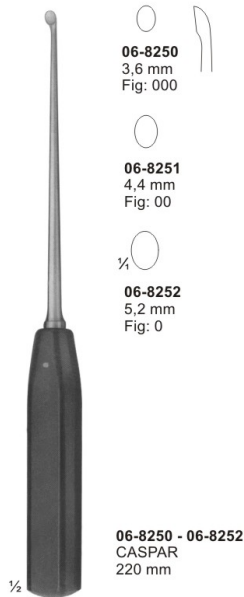
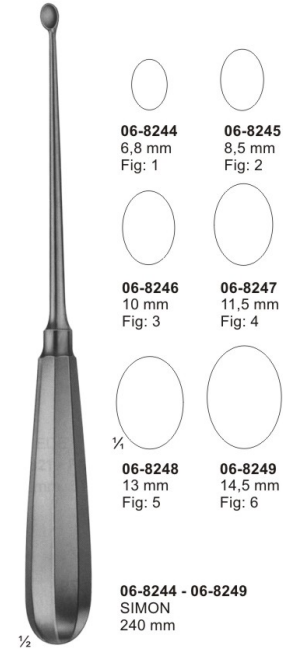
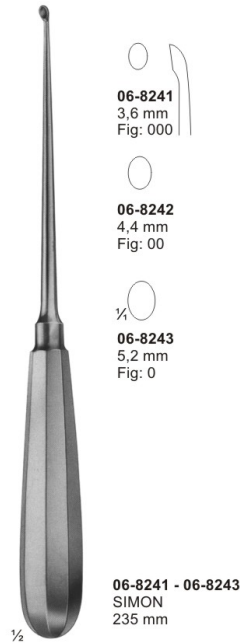

Bone Currettes With Hartpress Handle

can be sterilized in a steam sterilizer upto 3 bar over pressure (143 C).



06-8259 - 06-8262
270 mm

- 4,4 mm
Fig. 00
06-8259
- 6,8 mm
Fig. 1
06-8260
- 8,5 mm
Fig. 2
06-8261
- 10 mm
Fig. 3
06-8262



06-8263 - 06-8270
SYPERT
380 mm

- | | |
|--------------------------------|--------------------------------|
| 2,8 mm
Fig. 0000
06-8263 | 2,8 mm
Fig. 0000
06-8267 |
| 3,6 mm
Fig. 000
06-8264 | 3,6 mm
Fig. 000
06-8268 |
| 5,2 mm
Fig. 0
06-8265 | 5,2 mm
Fig. 0
06-8269 |
| 10,0 mm
Fig. 3
06-8266 | 10,0 mm
Fig. 3
06-8270 |

**Mallets Weight Refer To The Heads Of
The Mallets**



06-8271
MEAD
185 g
with interchangeable
plastic disks
190 mm
06-8272
pair of spare disks



06-8273
140 g
with interchangeable
plastic disks
185 mm
06-8274
pair of spare disks



06-8275
COTTLE
240 g
1 Side flat
1 Side convex
185 mm



06-8276
165 g
lead filled head
190 mm

Mallets, Weights Refer To The Heads Of The



06-8277
HAJEK
140 g
220 mm



06-8278
215 g
with interchangeable
plastic disks
245 mm
06-8279
pair of spare disks

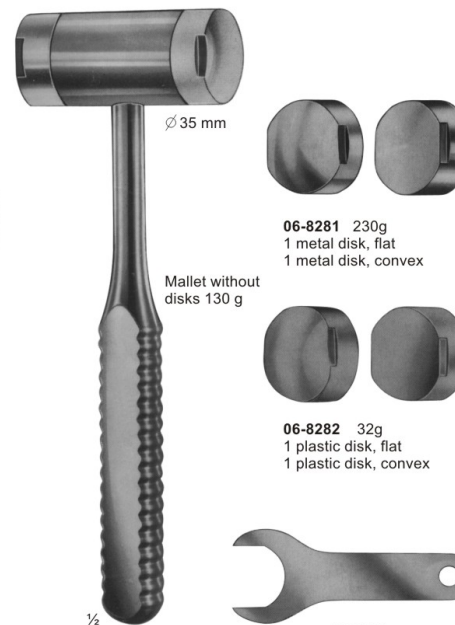

06-8280 - 06-8283
WAGNER
complete with:
1 pair of metal disks (**06-8281**) and
1 pair of plastic disks (**06-8282**) and
1 wrench (**06-8283**)
235 mm

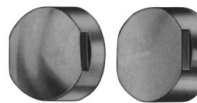

06-8281 230g
1 metal disk, flat
1 metal disk, convex

Mallet without
disks 130 g

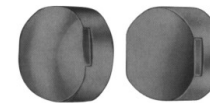

06-8282 32g
1 plastic disk, flat
1 plastic disk, convex

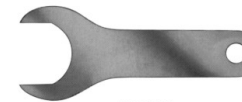

06-8283
Wrench

Mallets Weight Refer To The Heads Of The Mallets



06-8284 300g
BERGMANN
245 mm



06-8285 300g
BERGMANN
235 mm



06-8286 550g
OMBREDANNE
240 mm

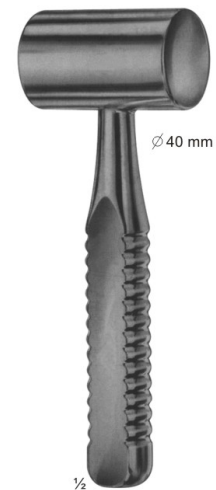

06-8287
HEATH
copper filled head
700 g
185 mm

Tampers - Osteotomes, Chisels and Gouges

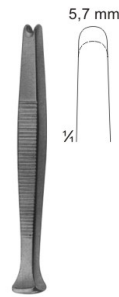

06-8288
HAASE
100 mm



06-8289 - 06-8290
PASSOW
120 mm

□
06-8289
2.5 mm
1/4 □
06-8290
3.5 mm



06-8291 - 06-8293
CASPAR
200 mm

●
06-8291
∅ 3 mm
●
06-8292
∅ 5 mm
1/4 ●
06-8293
∅ 8 mm



06-8294 - 06-8296
200 mm

●
06-8294
∅ 12 mm
●
06-8295
∅ 14 mm
1/4 ●
06-8296
∅ 16 mm

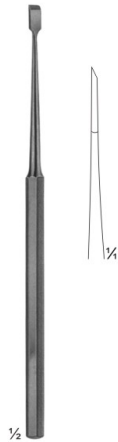

06-8297 4mm
FREER
Chisel
160 mm

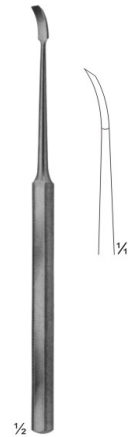

06-8298 4mm
FREER
Chisel, curved
160 mm

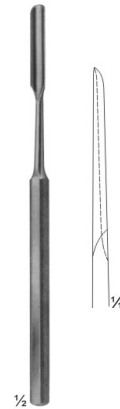

06-8299 6mm
FREER
Gouge
150 mm

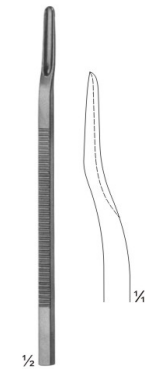

06-8300 3.4mm
Scaphoid gouge,
downwards curved
135 mm

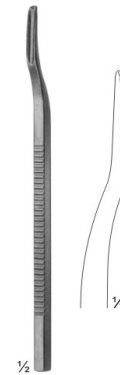

06-8301 3.4mm
Scaphoid gouge,
upwards curved
135 mm



06-8302 - 06-8304
MANNERFELT modif
Osteotomes
06-8302 4 mm
06-8303 6 mm
06-8304 8 mm
155 mm

Osteotomes Chisels and Gouges

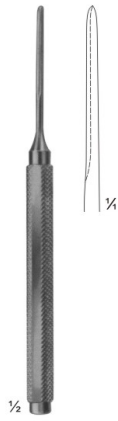

06-8305 3mm
MANNERFELT modif.
Gouge
155 mm

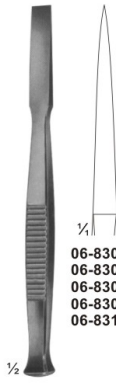

06-8306 - 06-8310
Osteotomes
140 mm

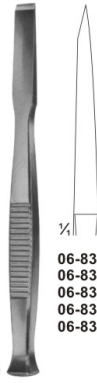

06-8311 - 06-8315
Chisels
140 mm

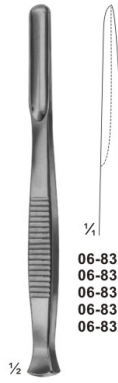

06-8316 - 06-8320
Gouges
140 mm

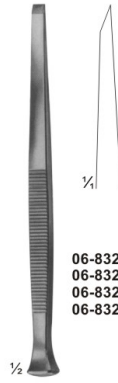

PARTSCH
06-8321 - 06-8324
Chisels
140 mm

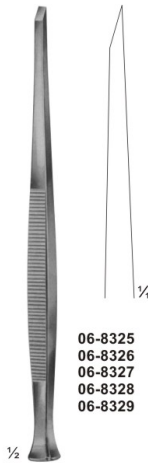

PARTSCH
06-8325 - 06-8329
Chisels
170 mm

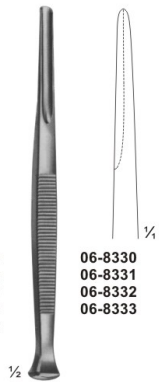

PARTSCH
06-8330 - 06-8333
Gouges
140 mm

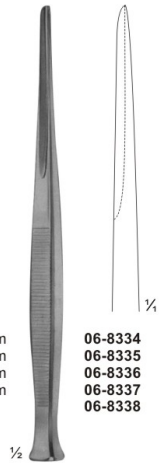

PARTSCH
06-8334 - 06-8338
Gouges
170 mm

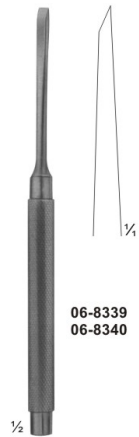

LUCAS
06-8339 - 06-8340
Chisels
160 mm



LUCAS
06-8341 - 06-8342
Gouges
160 mm

Osteotomes Chisels and Gouges

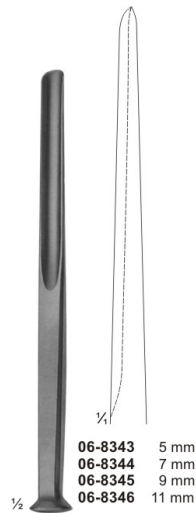

06-8343 5 mm
06-8344 7 mm
06-8345 9 mm
06-8346 11 mm

ALEXANDER
06-8343 - 06-8346
Gouges
170 mm

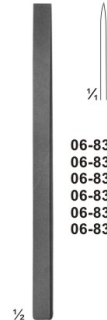

06-8347 4 mm
06-8348 6 mm
06-8349 8 mm
06-8350 10 mm
06-8351 12 mm
06-8352 15 mm

LAMBOTTE
06-8347 - 06-8352
Osteotomes
125 mm

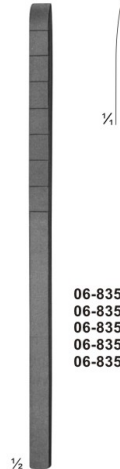

06-8353 4 mm
06-8354 6 mm
06-8355 8 mm
06-8356 10 mm
06-8357 12 mm

COTTLE
06-8353 - 06-8357
Osteotomes with depth
markings
180 mm

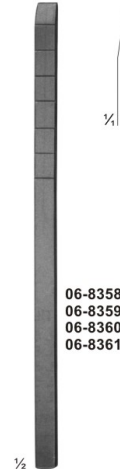

06-8358 4 mm
06-8359 7 mm
06-8360 9 mm
06-8361 12 mm

COTTLE
06-8358 - 06-8361
Chisel-Osteotomes
with depth markings
180 mm



COTTLE
06-8362 8mm
Fishtail Chisel,
with protected ends
180 mm

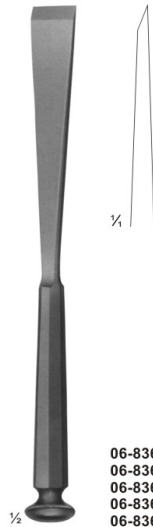

06-8363 10 mm
06-8364 12 mm
06-8365 15 mm
06-8366 20 mm
06-8367 25 mm

STILLE
06-8363 - 06-8367
Chisels
205 mm

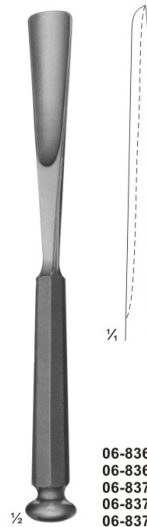

06-8368 10 mm
06-8369 12 mm
06-8370 15 mm
06-8371 20 mm
06-8372 25 mm

STILLE
06-8368 - 06-8372
Gouges
205 mm

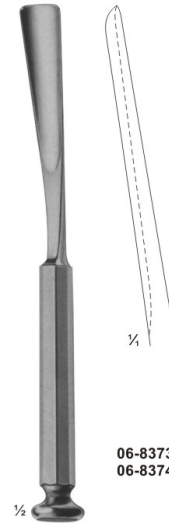

06-8373 10 mm
06-8374 15 mm

WALTER
06-8373 - 06-8374
gouges for taking
grafts from the ribs
205 mm















06-8375 8mm
06-8376 10 mm
06-8377 12 mm
06-8378 15 mm
06-8379 20 mm
06-8380 25 mm

STILLE
06-8375 - 06-8380
Osteotomes
205 mm

Osteotomes

<p>06-8381 10 mm 06-8382 12 mm 06-8383 15 mm 06-8384 20 mm 06-8385 25 mm</p>	<p>06-8386 10 mm 06-8387 12 mm 06-8388 15 mm 06-8389 20 mm 06-8390 25 mm</p>	<p>06-8391 4 mm 06-8392 8 mm 06-8393 10 mm 06-8394 13 mm 06-8395 15 mm 06-8396 18 mm 06-8397 20 mm 06-8398 25 mm 06-8399 30 mm 06-8400 38 mm 06-8401 44 mm 06-8402 50 mm</p>	<p>06-8403 8 mm 06-8404 13 mm 06-8405 18 mm 06-8406 25 mm 06-8407 30 mm 06-8408 38 mm</p>
<p>STILLE 06-8381 - 06-8385 Osteotomes 205 mm</p>	<p>STILLE 06-8386 - 06-8390 Osteotomes, curved 205 mm</p>	<p>LAMBOTTE 06-8391 - 06-8402 Osteotomes 245 mm</p>	<p>LAMBOTTE 06-8403 - 06-8408 Osteotomes, curved 245 mm</p>

**Osteotomes, Chisels and Gouges with
HARTPRESS -handle**

		<p>06-8409 4 mm 06-8410 6 mm 06-8411 8 mm 06-8412 10 mm 06-8413 12 mm</p>			<p>06-8414 4 mm 06-8415 6 mm 06-8416 8 mm 06-8417 10 mm 06-8418 12 mm</p>			<p>06-8419 5 mm 06-8420 7 mm 06-8421 10 mm 06-8422 15 mm 06-8423 20 mm 06-8424 25 mm 06-8425 30 mm</p>		
<p>LEXER-MINI 06-8409 - 06-8413 Osteotomes 180 mm</p>	<p>LEXER-MINI 06-8414 - 06-8418 Gouges 180 mm</p>	<p>LEXER 06-8419 - 06-8425 Gouges 220 mm</p>			<p>06-8426 5 mm 06-8427 7 mm 06-8428 10 mm 06-8429 15 mm 06-8430 20 mm 06-8431 25 mm 06-8432 30 mm</p>					<p>06-8434 5,5 mm 06-8435 9,0 mm</p>
<p>LEXER 06-8426 - 06-8432 Osteotomes 220 mm</p>	<p>06-8433 9mm Gouge for removing broken screws 220 mm</p>	<p>ZIELKE 06-8434 - 06-8435 Gouges for scoliosis-operations 230 mm</p>								

**Osteotomes ,Chisels and Gouges with
HARTPRESS -handle**



Reposition Forceps



06-8442
Reposition forceps,
for small fragments
135 mm

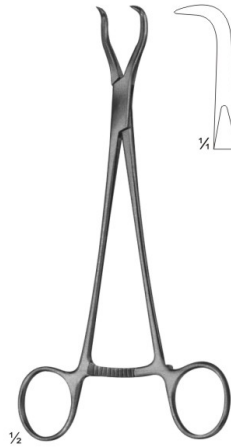

06-8443
HAASE
Reposition forceps,
for mandibular
fractures
165 mm

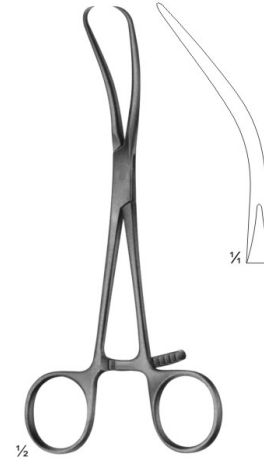

06-8444
REILL
Reposition forceps,
170 mm



06-8445
Reposition forceps
205 mm

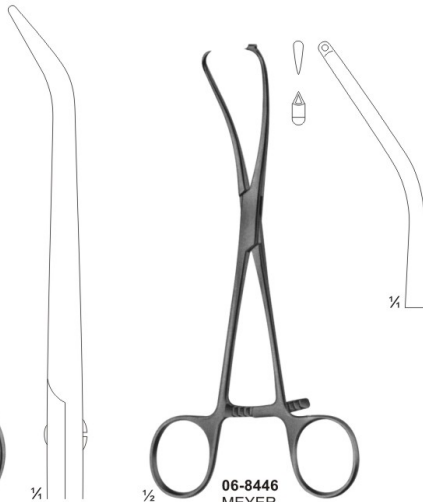

06-8446
MEYER
Reposition forceps
for fingers, with drill
guide for KIRSCHNER
wires up to daim.1.0 mm
170 mm

Reposition Forceps, Bone Holding Forceps



06-8447
Patella forceps
185 mm



06-8448
Forceps with
ratchet fixation
140 mm



06-8449
Forceps with
thread fixation
170 mm



06-8450
Forceps with
thread fixation
235 mm

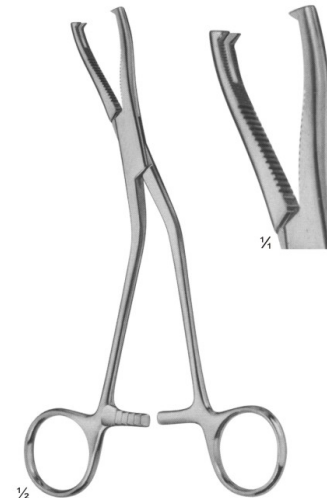

06-8451
DINGMANN modif
185 mm

Bone Holding Forceps



06-8452
Sequestrum
forceps
200 mm



06-8453
VAN BUREN
Sequestrum
forceps
225 mm

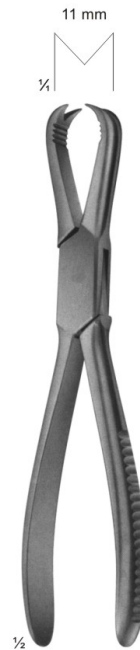

06-8454
LANGENBECK
205 mm



06-8455
FERGUSSON
205 mm

Bone Holding Forceps

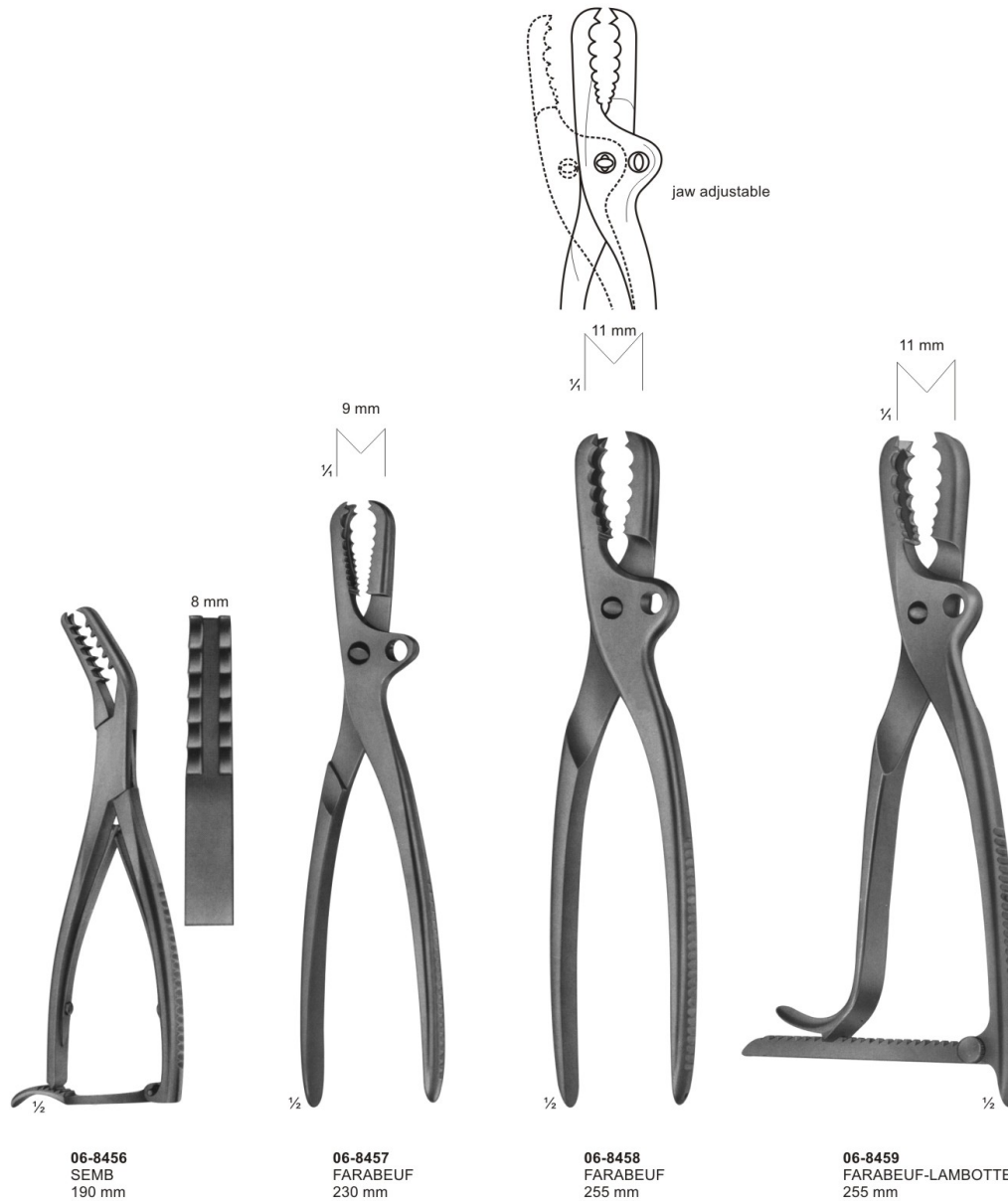

Bone Holding Forceps

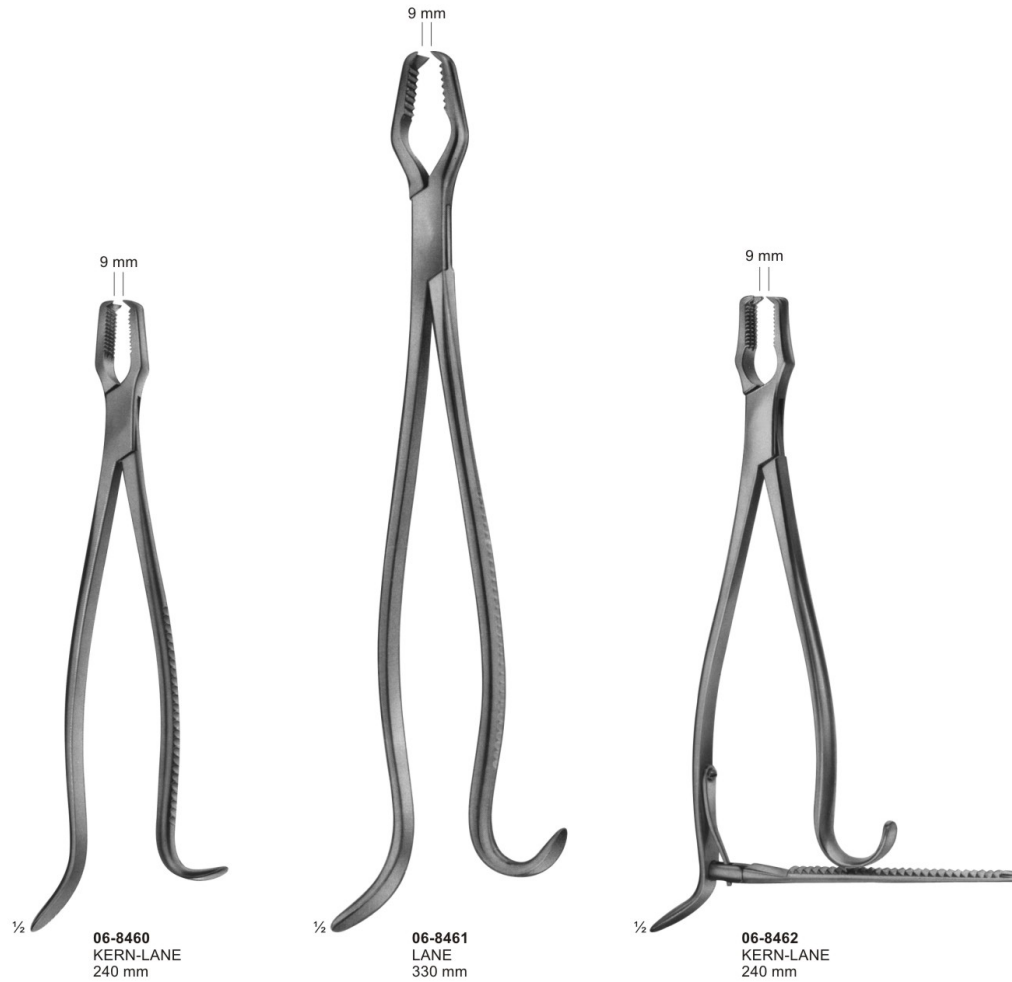

Bone Holding Forceps



Bone Holding Forceps

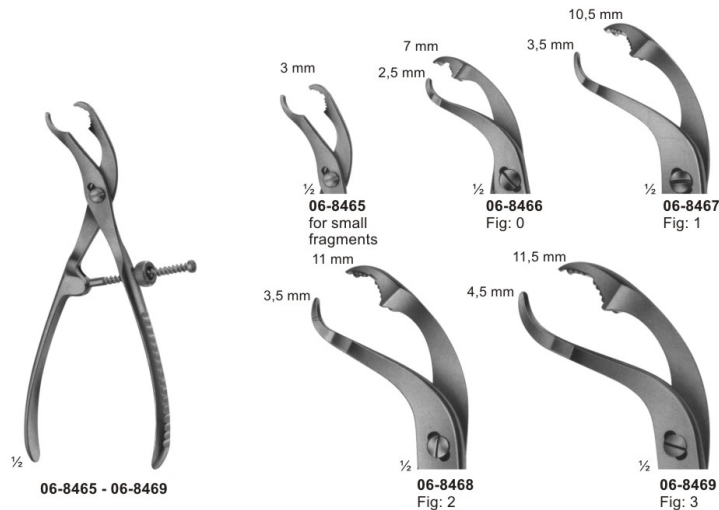

06-8465 - 06-8469

- 06-8465 145 mm
- 06-8466 190 mm
- 06-8467 240 mm
- 06-8468 260 mm
- 06-8469 280 mm

Self-centering forceps
with thread fixation

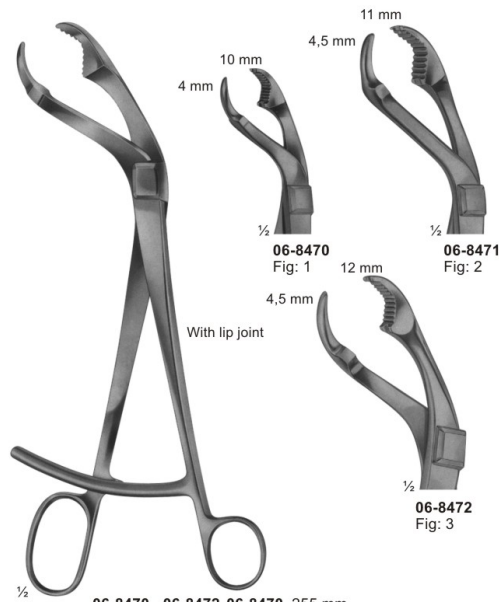

06-8470 - 06-8472 06-8470 255 mm
VERBRUGGE 06-8471 265 mm
06-8472 270 mm



06-8473
LAMBOTTE
265 mm

Bone Clamps



06-8474 - 06-8475
LOWMAN
06-8474 170 mm
06-8475 205 mm



06-8476
LOWMAN-GERSTER
210 mm



06-8477
LOWMAN-HOGLUND
175 mm

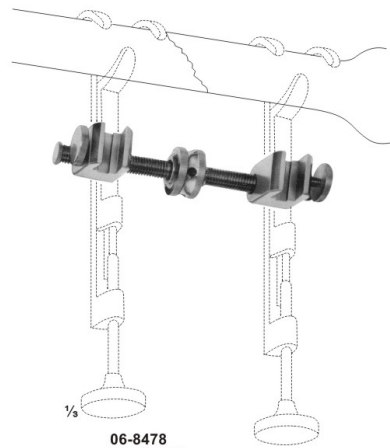

06-8478
GERSTER
Traction bar for 06-8474 - 06-8477

Synovectomy-Rongeurs, Bone Rongeurs



06-8479 - 06-8480
Synovectomy rongeur
width of jaws 1.2 mm
130 mm



06-8481 - 06-8482
Synovectomy rongeur
width of jaws 2.0 mm
130 mm



06-8483
STELLBRINK
Synovectomy rongeur
175 mm



06-8484
STELLBRINK
Synovectomy rongeur
170 mm



06-8485
LUER-FRIEDMANN
145 mm



06-8486
140 mm

Bone Rongeurs



06-8487
LUER
150 mm

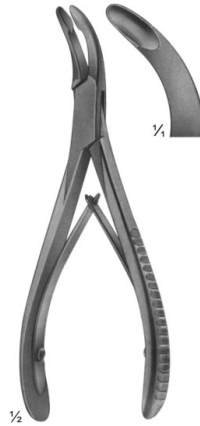

06-8488
LUER
155 mm



06-8489
BLUMENTHAL
155 mm

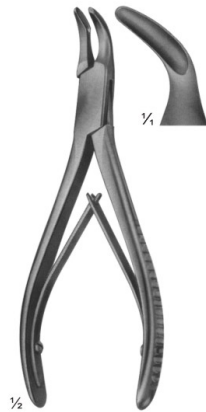

06-8490
BLUMENTHAL
150 mm



06-8491 - 06-8492
JANSEN
175 mm

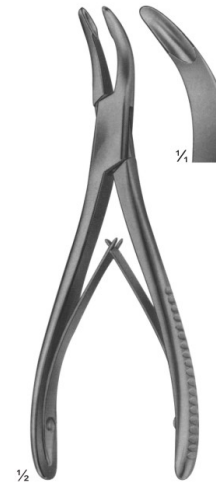

06-8493
BANE-HARTMANN
175 mm

Bone Rongeurs

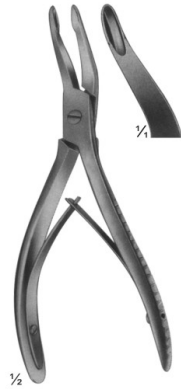

06-8494
ALEXANDER
140 mm

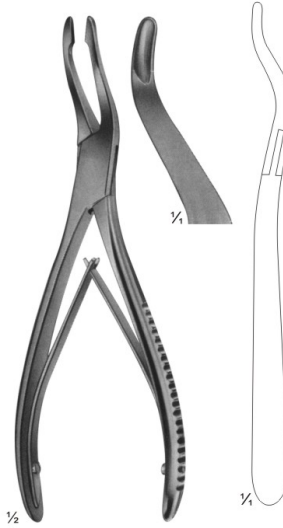

06-8495
JANSEN
190 mm

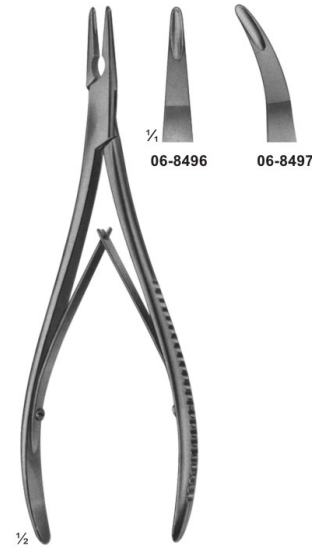

06-8496 - 06-8497
LEMPERT
200 mm

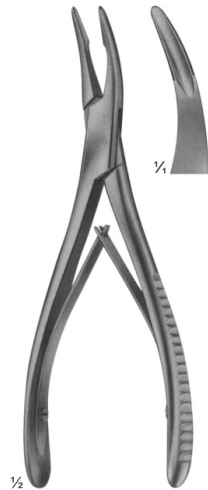

06-8498
BEYER
180 mm

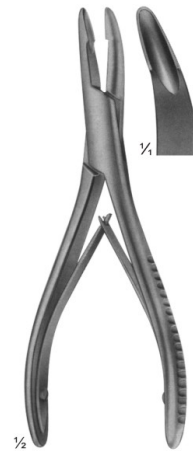

06-8499
MEAD
165 mm

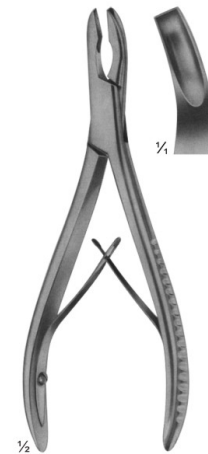

06-8500
MEAD
165 mm

Bone Rongeurs

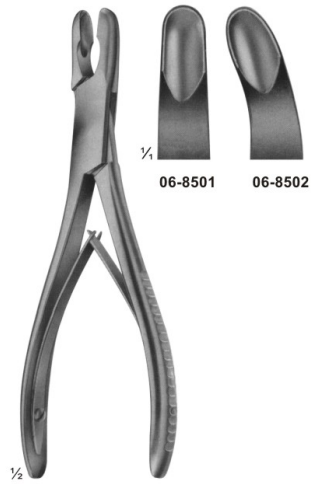

06-8501 - 06-8502
LUER
175 mm

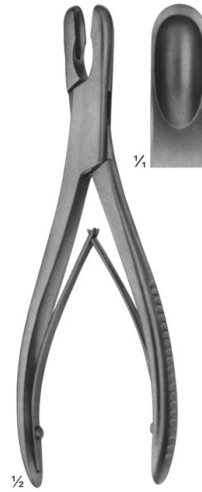

06-8503
LUER
180 mm

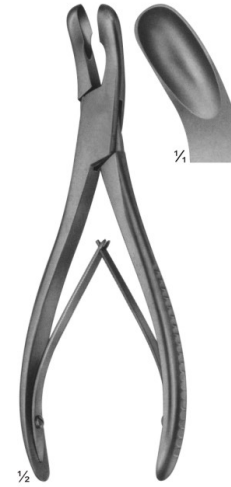

06-8504
LUER
180 mm

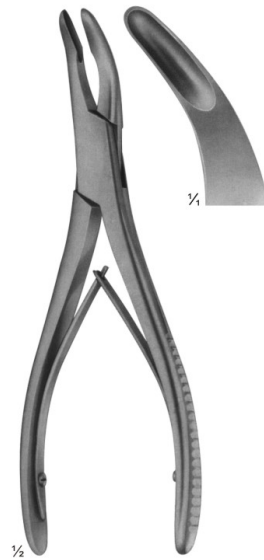

06-8505
OLIVECRONA
205 mm



06-8506 - 06-8507
BOHLER
155 mm



06-8508
MARQUARDT
200 mm

Bone Rongeurs

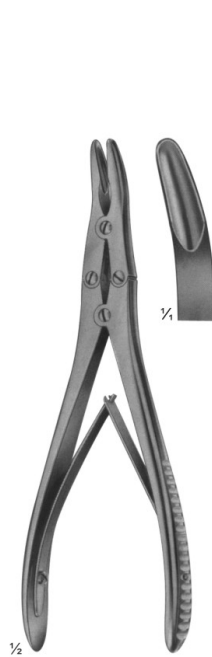

06-8509
RUSKIN
190 mm



06-8510
ROETTGEN-RUSKIN
240 mm

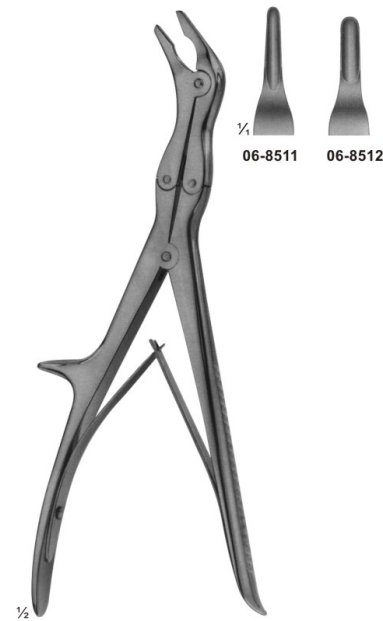

06-8511 - 06-8512
ECHLIN
230 mm

Bone Rongeurs



06-8513
STILLE
235 mm



06-8514
LEKSELL-STILLE
240mm



06-8515
STILLE-RUSKIN
240mm

Bone Rongeurs



06-8516
LUER-STILLE
225 mm



06-8517
LUER-STILLE
225 mm

Bone Rongeurs



06-8518
LUER-STILLE
270 mm

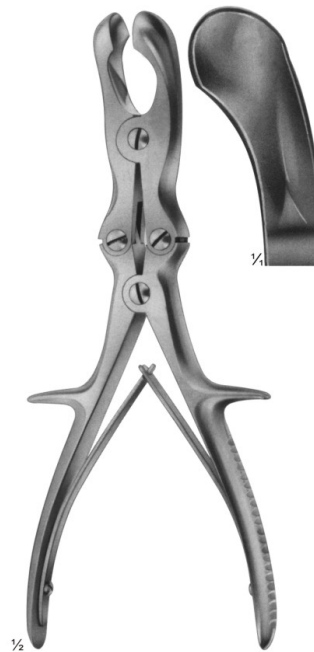

06-8519
SEMB
240 mm

Bone Cutting Forceps

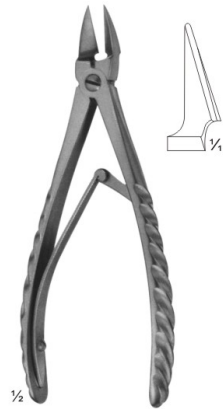

06-8520
STAMM
150 mm



06-8521
KAZANJIAN
185 mm



06-8522 - 06-8525
LISTON



06-8522
140 mm



06-8523
170 mm



06-8524
200 mm



06-8525
220 mm



06-8526 - 06-8528
LISTON



06-8526
170 mm



06-8527
200 mm



06-8528
220 mm

Bone Cutting Forceps



06-8529
BOEHLER
145 mm

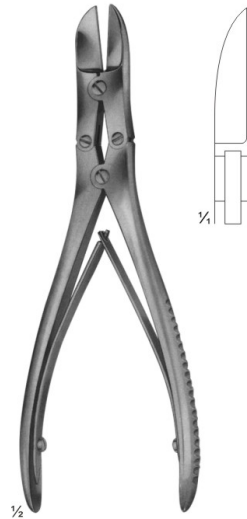

06-8530
RUSKIN-LISTON
190 mm



06-8531
RUSKIN-LISTON
190 mm

Bone Cutting Forceps

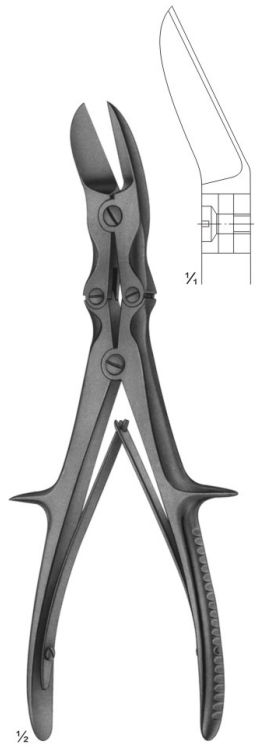

06-8532
LISTON
curved on flat
240 mm

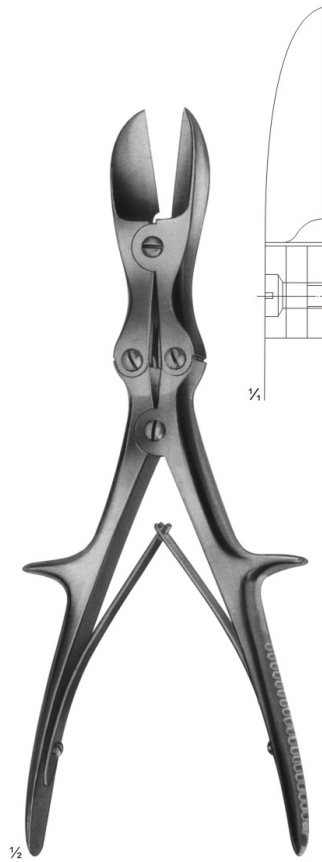

06-8533
LISTON
straight
280 mm



06-8534
LISTON
curved on flat
280 mm

Bone Cutting Forceps

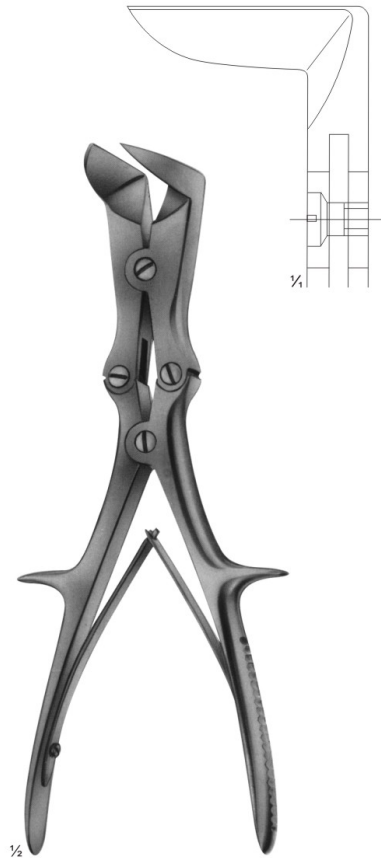

06-8535
LISTON-STILLE
265 mm

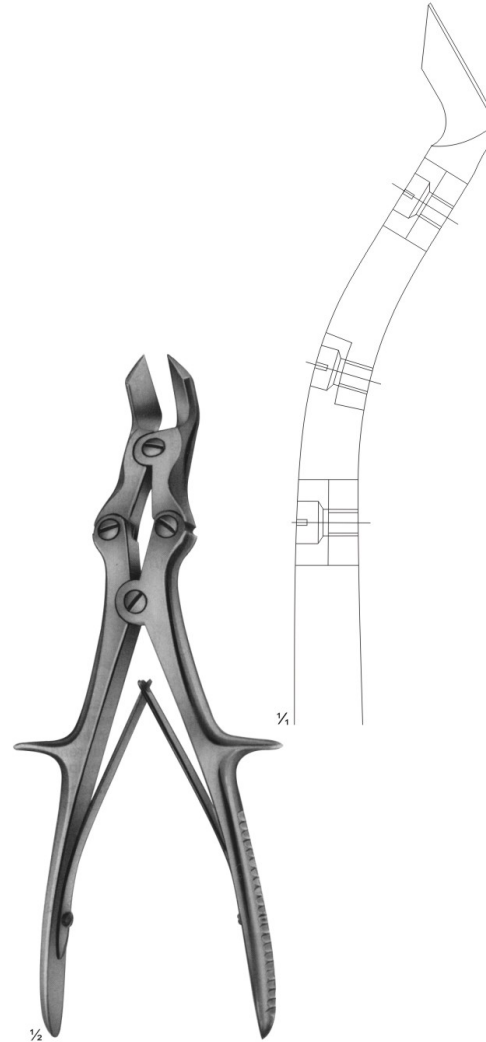

06-8536
LISTON-KEY-HORSLEY
(TUDOR EDWARDS)
255 mm

Meniscus-and Cartilage Forceps

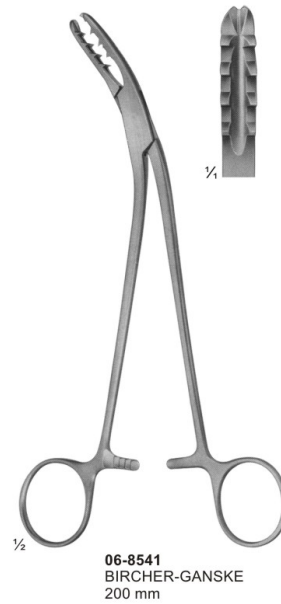
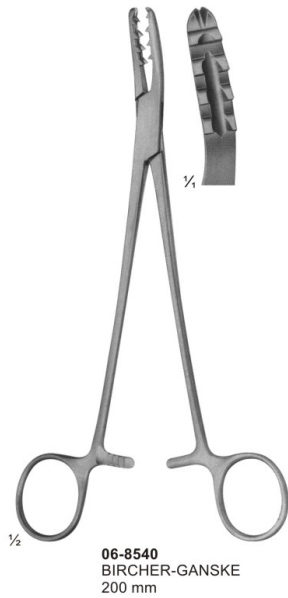
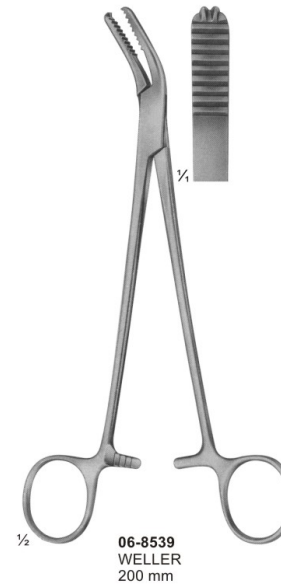

Meniscus Knives

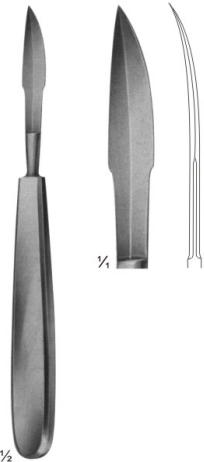

1/2
06-8543
170 mm

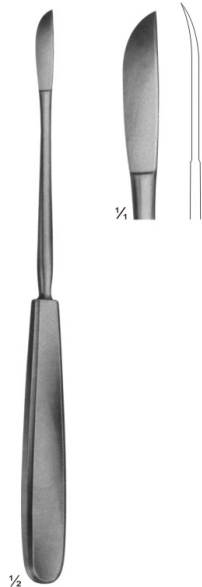

1/2
06-8544
NEFF
215 mm



1/2
06-8545
NEFF
215 mm



1/2
06-8546
WAGNER
215 mm

Meniscus Knives

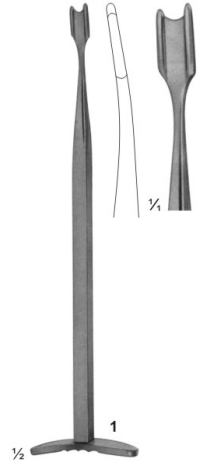

06-8547
SMILLIE
170 mm

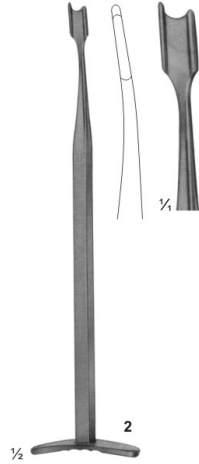

06-8548
SMILLIE
170 mm

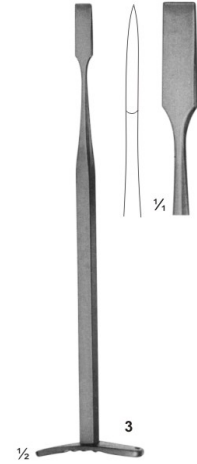

06-8549
SMILLIE
170 mm

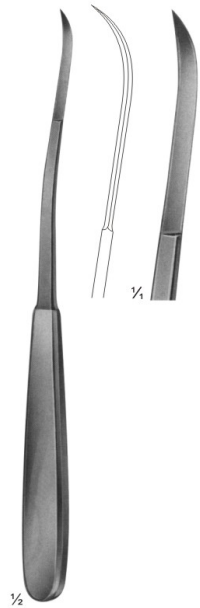

06-8550
SALENIUS
220 mm

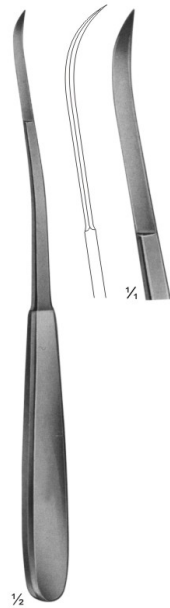

06-8551
SALENIUS
220 mm

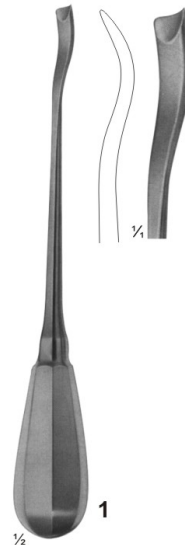

06-8552
CANAD. MODELL
200 mm

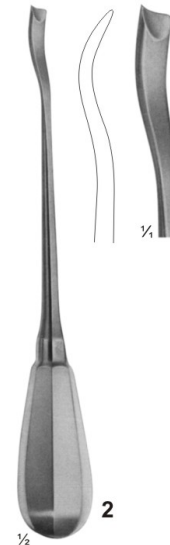

06-8553
CANAD. MODELL
200 mm

Wire Extension

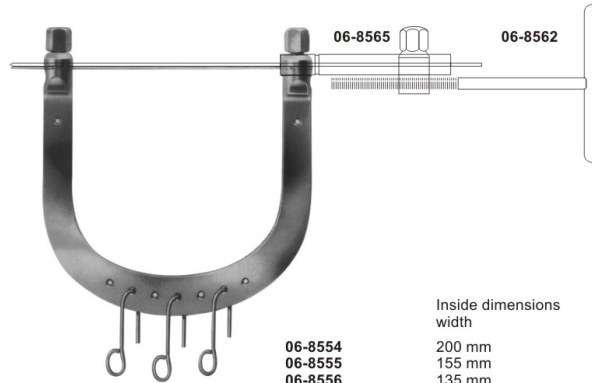

06-8554 - 06-8560
KIRSCHNER
Wire traction bows,
to be used with
KIRSCHNER-wires
up to 2.5 mm diam.,
With 3 hooks,
stainless steel

06-8554
06-8555
06-8556
06-8557
06-8558
06-8559
06-8560

Inside dimensions
width

200 mm
155 mm
135 mm
120 mm
105 mm
95 mm
95 mm

depth

155 mm for the hip
155 mm for the femur
130 mm for the knee
120 mm for the knee
100 mm for the knee
110 mm for the calcaneus
70 mm for the arm and elbow



06-8561
Wrench, double - ended,
for wire traction bows

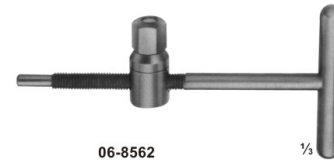

06-8562
Wire tightener, with
clamping jaws



06-8563
Traction hook only,
large size



06-8564
Traction hook only,
small size



06-8565
Fixation clamp, to secure clamping
jaws of **06-8562** stainless steel

Wire Extension

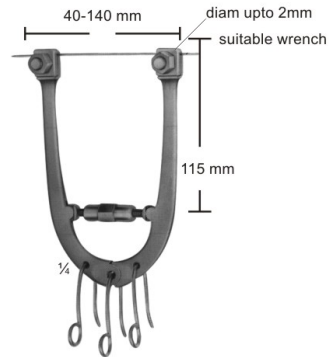

06-8566
Wire traction bow, adjustable,
with 3 hooks, small size

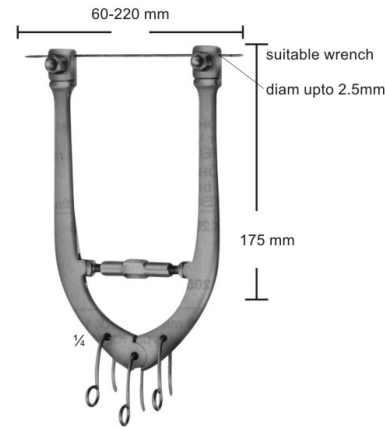

06-8567
Wire traction bow, adjustable,
with 3 hooks, large size

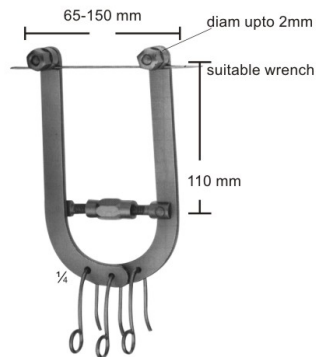

06-8568
Wire traction bow, adjustable,
with 3 hooks, small size for
elbow and calcaneus, for
adolescents

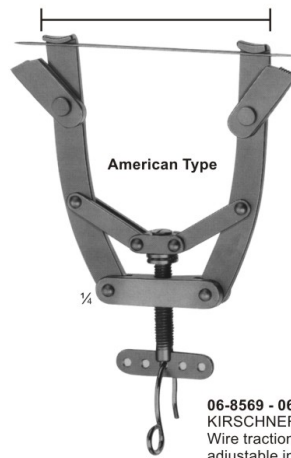

American Type

06-8569 max. 105 mm
06-8570 max. 160 mm
06-8571 max. 200 mm

06-8569 80-95 mm
06-8570 90-120 mm
06-8571 140-170 mm

diam upto
06-8569 1,6 mm
06-8570 2,0 mm
06-8571 2,5 mm

06-8569 - 06-8571
KIRSCHNER
Wire traction bows, modified,
adjustable in width, holds wire
securely, with 1 hook



06-8572
Fixation disc, slotted



06-8573
idem, aluminum, transparent
to X-rays



06-8574
Fixation disc, slotted



06-8575
Screw driver, for above
fixations discs

Traction Bows, Distractor

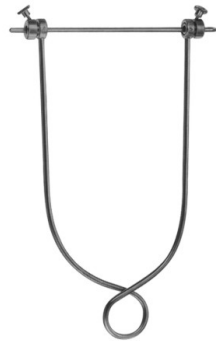

Boehler traction bows, to be used with STEINMANN pins, 4mm diam	Boehler traction bows, to be used with STEINMANN pins, 5mm diam	Inside width	For
06-8576 with pin (09-8588)		16x9cm	Arm
06-8577 without pin	06-8582 without pin		
06-8578 with pin (09-8590)		21x11cm	Femur and knee
06-8579 without pin	06-8583 without pin		
06-8580 with pin (09-8592)		21x15cm	Femur and knee
06-8581 without pin			



06-8584 - 06-8598
STEINMANN
triangular shaft ended and trocar point

diam ϕ	4,0 mm	5,0 mm
Length		
80 mm	06-8584	
100 mm	06-8585	
120 mm	06-8586	
140 mm	06-8587	
150 mm	06-8588	06-8594
160 mm	06-8589	06-8595
180 mm	06-8590	06-8596
200 mm	06-8591	06-8596
210 mm	06-8592	
250 mm	06-8593	06-8597
300 mm		06-8598



06-8599
SCHWARZ
Traction bow for fingers,
to be used with KIRSCHNER-
wire up to 1.6 mm diam.

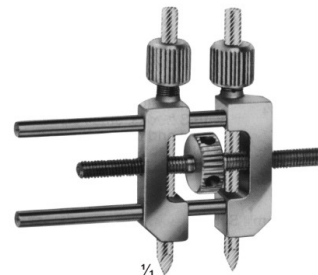

06-8600
Small distractor
as a repositioning device for
distraction and compression of small bones,
for wires with 3.0 mm diam.



06-8601
Protection cap
for 4,0 mm STEINMANN Pins



06-8602
Protection cap
for 5,0 mm STEINMANN Pins

Drilling Chucks and Cerclage Wire Tightener



06-8603
REILL
Drilling chuck, cannulated, for shanks from 2.0 - 2.5 mm diam 115 mm



06-8604
Drilling chuck, cannulated, for shanks from 0.8 - 2.0 mm diam 150 mm



06-8605
Drilling chuck, cannulated, for shanks up to 4.5 mm diam with key 140 mm

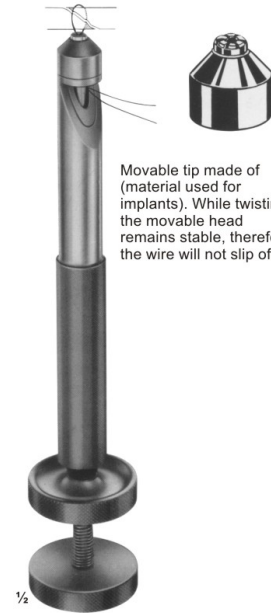

Movable tip made of (material used for implants). While twisting the movable head remains stable, therefore the wire will not slip off.

06-8606
LOUTE
Wire tightener, improved pattern, with movable tip, for wires up to 1.0 mm diam. 220 mm

Chuck jaws made of material used for implants



06-8607
Drilling chuck, cannulated, for shanks up to 6.35 mm diam., To be tightened by hand 100 mm



06-8608
Drilling chuck, cannulated, for shanks up to 4.5 mm diam., And for triangular shaft width across flats 4.7 mm (schanz screws, steinmann pins). with key **06-8609**



06-8610
Drilling chuck, cannulated, for shanks up to 6.35 mm diam., With key (**06-8611**) 160 mm

Cerclage Instruments

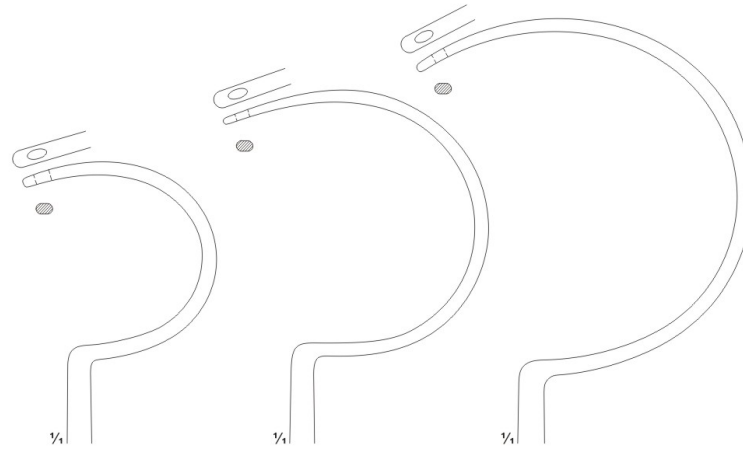

06-8612
275 mm

06-8613
285 mm

06-8614
305 mm



06-8612 - 06-8614
DEMEL
Wire guides

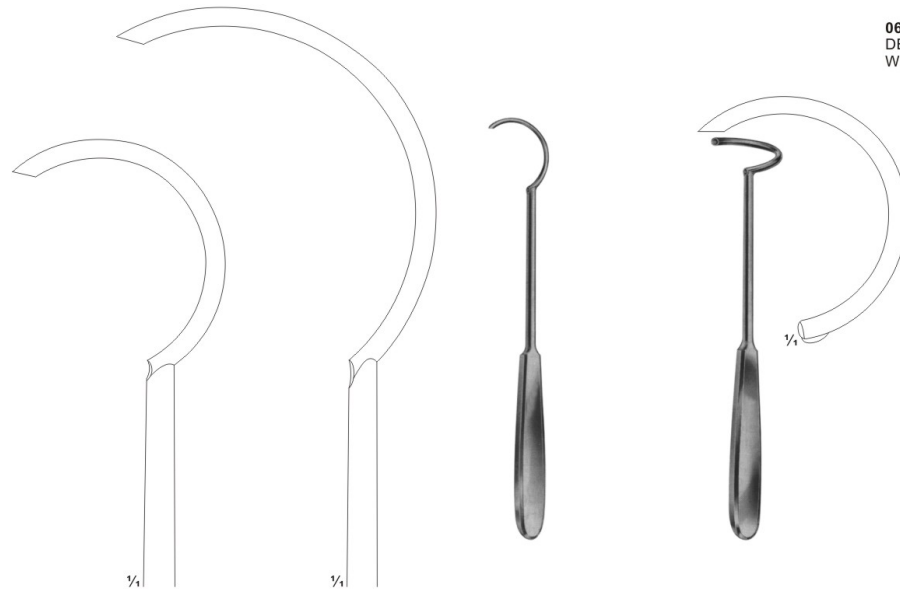

06-8615
240 mm

06-8616
270 mm

06-8617
225 mm

**JORDAN instruments for subcutaneous
Tibia Cerclage**

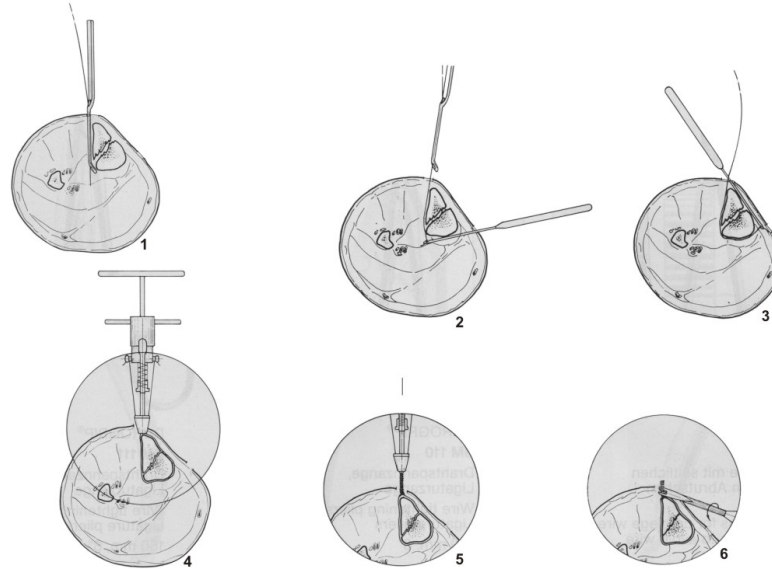

06-8618
JORDAN
Wire tightener



06-8619
JORDAN
Wire twister
170 mm



06-8620
JORDAN
Wire catcher
180 mm



06-8621
JORDAN
Probe, cannulated
170 mm

**Wire Holding forceps, Wire Tightening Pliers,
Flat-nosed Pliers DUROGRIP with Hard Metal
Inserts**

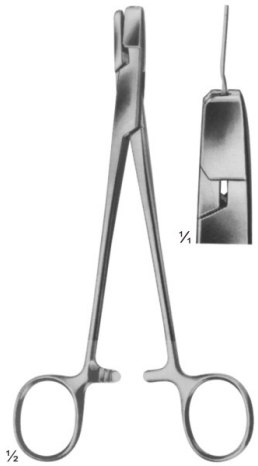

06-8622
DUROGRIP
Holding forceps for cerclage
wire, with lateral jaws to avoid
wire slipping off
170 mm



06-8623
DUROGRIP
Wire, tightening pliers,
Ligature pliers
150 mm



06-8624
DUROGRIP
Wire, tightening pliers,
Ligature pliers
150 mm



06-8625
with serrated jaws
140 mm



06-8626
one jaw smooth,
one jaw serrated
140 mm



06-8627
with serrated jaws
06-8628
with longitudinal and
transversal grooves
170 mm



06-8629
190 mm

**Wire Holding forceps, Flat-nosed Pliers,
Pliers for bending and cutting wires**



06-8630
130 mm

06-8631
180 mm



06-8630 - 06-8631
Extraction pliers
for boring wires



06-8632
Flat-nosed pliers,
parallel
185 mm

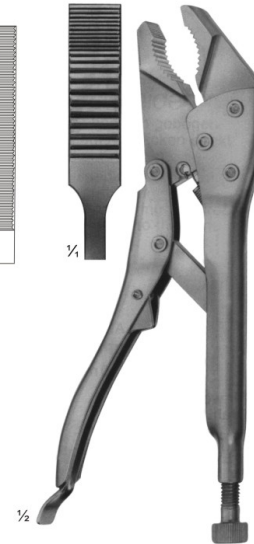
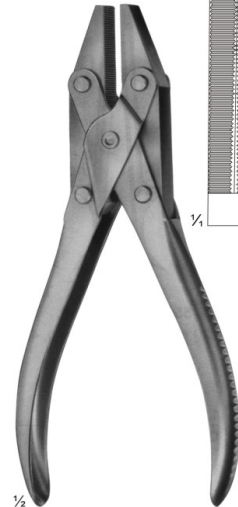

06-8633
Vise grip
200 mm

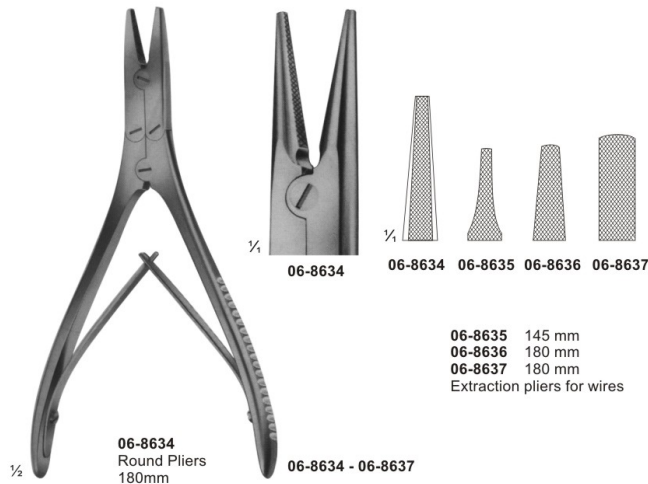

06-8634
Round Pliers
180mm

06-8634 - 06-8637

06-8635 145 mm
06-8636 180 mm
06-8637 180 mm
Extraction pliers for wires



06-8638
Bending pliers
for wires up to
1.8 mm diam.



Wire Cutters and wire Cutting Scissors
DUROTIP with Carbide Cutting Edges



06-8639 ANGLE
130 mm

06-8640 DUROTIP
ANGLE
130 mm

for soft wire
up to diam. 0,5 mm
for hard wire
up to diam. 0,3 mm

0,6 mm
0,4 mm

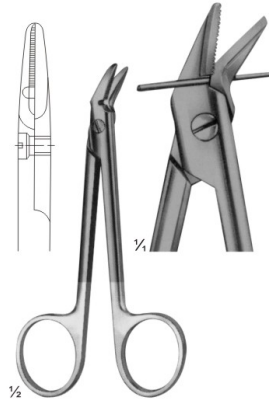

06-8641 120 mm

06-8642 DUROTIP
120 mm

for soft wire
up to diam. 1,2 mm
for hard wire
up to diam. 0,8 mm

1,2 mm
0,8 mm



06-8643 HARVEY
125 mm

0,4 mm
0,3 mm

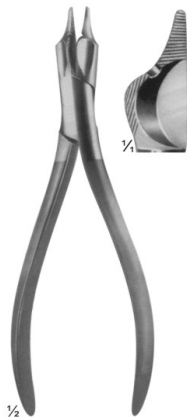

06-8644
150 mm

for soft wire
up to diam 1,5 mm
for hard wire
up to diam 1,0 mm



06-8645
160 mm

1,5 mm
1,2 mm



06-8646
140 mm
DUROTIP
1,5 mm

1,0 mm

Wire Cutting Pliers, Lateral Cutting Action



06-8647
180 mm

for soft wire
up to diam. 2,0 mm
For hard wire 1,5 mm
up to diam
specially hardened
cutting edges, front
and lateral cutting
action



06-8648
REILL
175 mm

for soft wire
up to diam. 2,0 mm
For hard wire 1,6 mm
up to diam
specially hardened
cutting edges, for
cutting off wires close
to the bone



DUROTIP

06-8649
235 mm

for soft wire
up to diam. 3,0 mm
For hard wire 2,2 mm
up to diam

**Wire Cutting Pliers, Lateral and Front
Cutting Action**

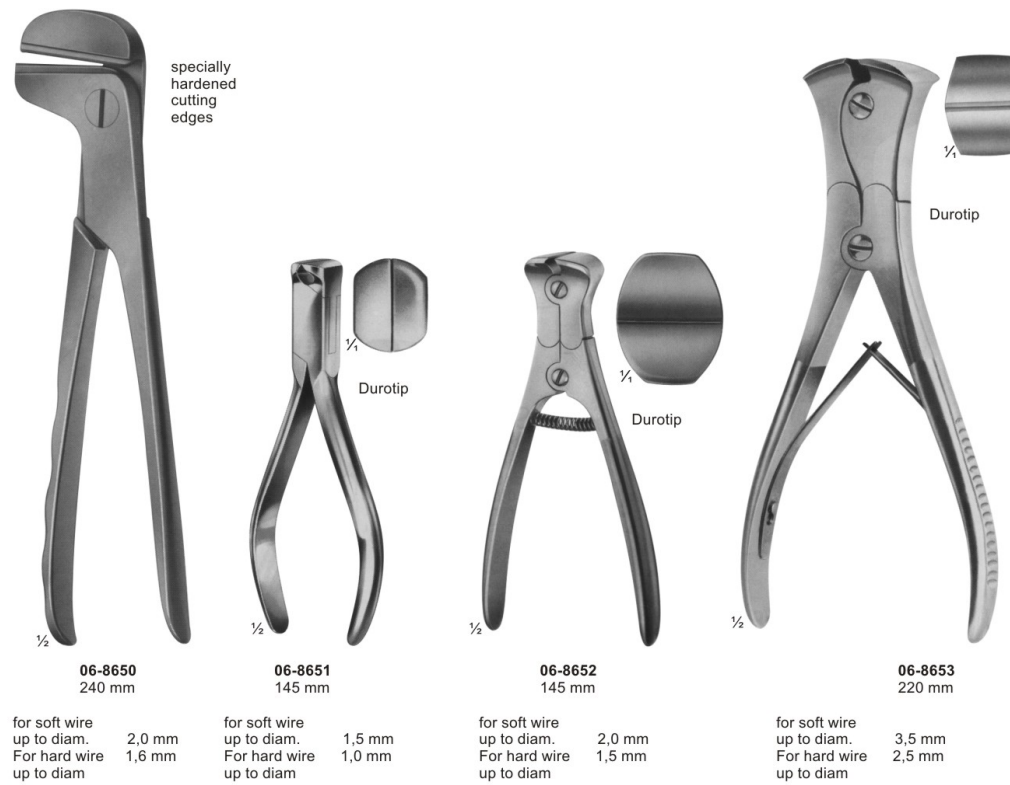

Wire Cutting Pliers



06-8654
320 mm

for soft wire
up to diam. 3,0 mm
For hard wire
up to diam 3,0 mm

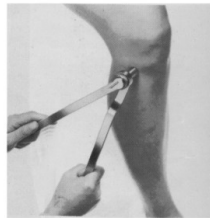

Cutter for cutting off
KIRSCHNER wires,
Tibia head screws,
bolts, pins, up to 3 mm diam.



DUROTIP

06-8655
Cutter for cutting off
KIRSCHNER wires,
Tibia head screws,
bolts, pins, up to 6 mm diam.
470 mm

Finger Nail Instruments

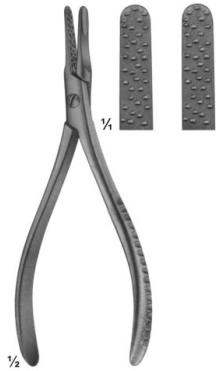

06-8656
Nail extracting
forceps
135 mm



06-8657
Nail extracting
forceps
145 mm



06-8658
Finger nail drill
with 3 drill points

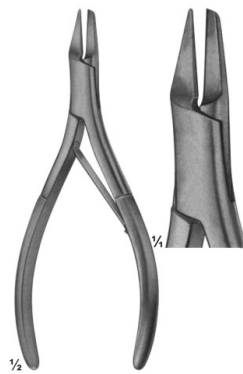

06-8662
Nail splitting
forceps
135 mm



06-8663
SYSTRUNK
Scissors, for splitting
finger nails
130 mm



06-8664
Finger ring saw
150 mm

Plaster Instruments

Plaster Knives



with ebony handle

07-9001
HOPKINS
200 mm



1/2

07-9002
ESMARCH
180 mm

Plaster Saw



1/2

07-9003
ENGEL
160 mm

Bandage and First-Aid scissors



1/2

07-9004 - 07-9012 145mm

07-9004 black	07-9008 yellow
07-9005 red	07-9009 white
07-9006 blue	07-9010 orange
07-9007 light green	07-9011 violet
	07-9012 bright pink



1/2

07-9013 - 07-9021 180mm

07-9013 black	07-9017 yellow
07-9014 red	07-9018 white
07-9015 blue	07-9019 orange
07-9016 light green	07-9020 violet
	07-9021 bright pink

Plaster Scissors

For small plaster dressings



07-9022
160 mm

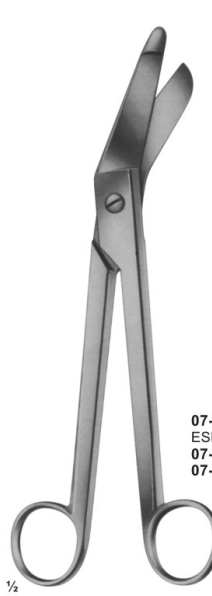

07-9023 - 07-9024
ESMARCH
07-9023 200mm
07-9024 230mm



07-9025
BERGMANN
230 mm



07-9026
BRUNS
235 mm



07-9027
235 mm

also to be used as
bandage scissors



07-9028
SEUTIN
230 mm

also to be used as
bandage scissors

Plaster Shears

Special features:

The construction of the open jaws avoids tiresome clogging by plaster remnants and allows furthermore an easy cleaning. The shears do not glide off the plaster owing to the deep teething on the jaws.

The knives with hollow grinding have a better cutting ability and therefore less force is required.

The knives are guided by ball bearings.

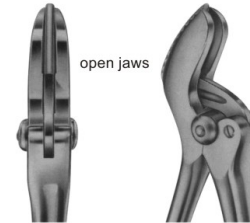

open jaws



07-9029A

Spare blade

open jaws

1/4

07-9029
STILLE
260 mm



07-9031

Spare blade

open jaws

1/4

07-9030
STILLE
360 mm

STILLE Plaster Shears

Blade with reinforced back



1/2

07-9032
STILLE
230 mm

07-9033
Spare blade



1/2

07-9034
STILLE
370 mm

07-9035
Spare blade



1/2

07-9036
STILLE
240 mm

07-9037
Spare blade

Plaster Spreader, Plaster Breakers



07-9038
HENNIG
270 mm



07-9039
MOD.USA
230 mm



07-9040
290 mm



with removable jaws



07-9041 - 07-9042
WOLFF
07-9041 180 mm
07-9042 240 mm
plaster breakers

Vacuum Curettes for Aspiration Lipectomy, Suction Instruments

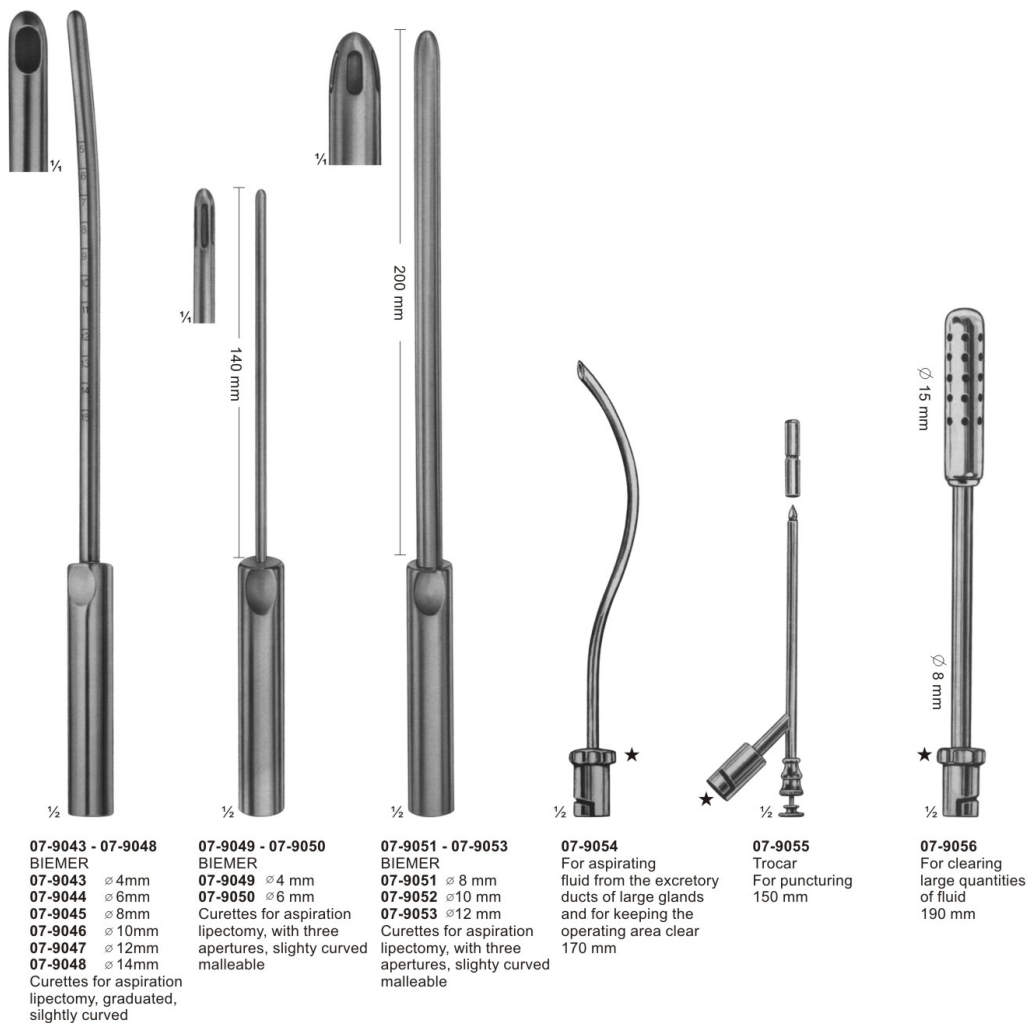

Suction Instruments

07-9057 150mm
Suction handle, with vacuum regulator and finger cut-off, brass, mirror-finish chromium-plated

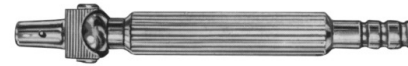

olive
Ø 9 mm

07-9058 170mm
Suction handle, with hand regulation valve and quick-shutter, brass, mirror-finish chromium-plated

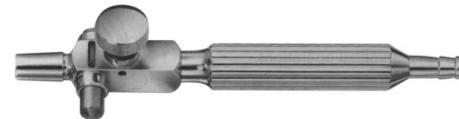

★ Both suction handles have bayonet fitting olive and can be used for the suction cannulae. Ø 9 mm



07-9059
Trocar
For puncturing
170 mm



★
07-9060
Hollow needle,
sharp
150 mm



★
07-9061
double curved
For general
surgery
230 mm



★
07-9062
For tonsillectomy,
oral and laryngeal
operations
190 mm



★
07-9063
For tonsillectomy,
oral and laryngeal
operations
220 mm

★ With bayonet fitting to be used with suction handles (07-9057 - 07-9058)

Suction Instruments

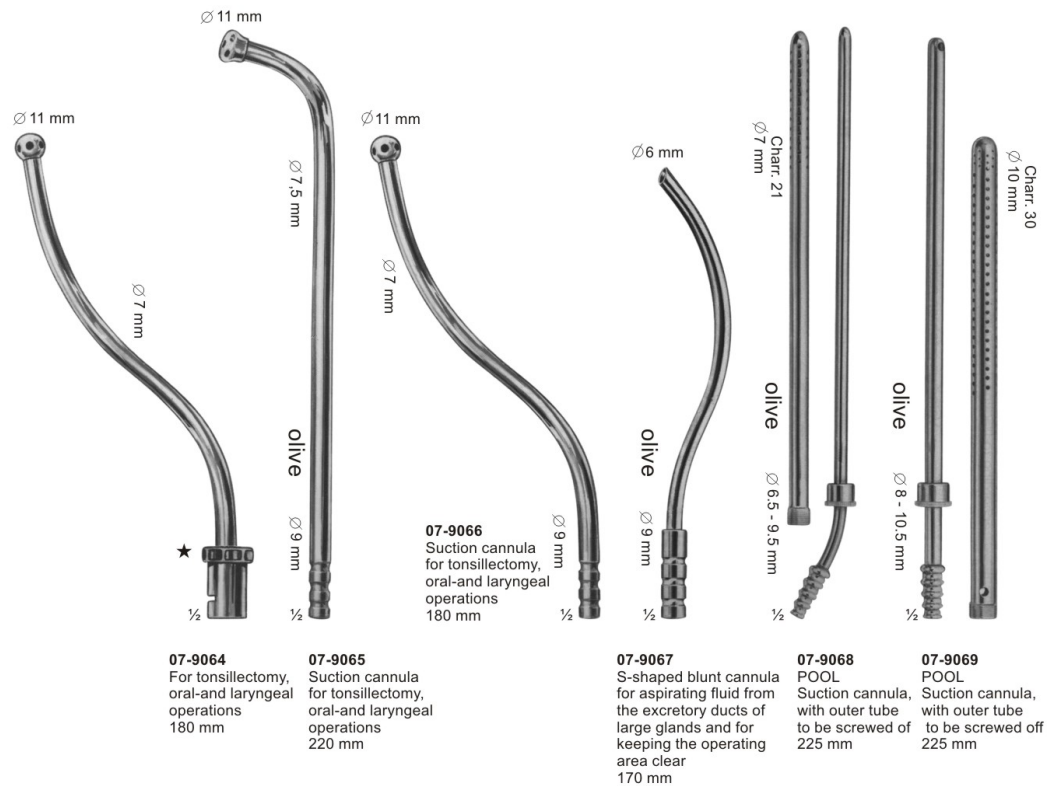

Suction Instruments

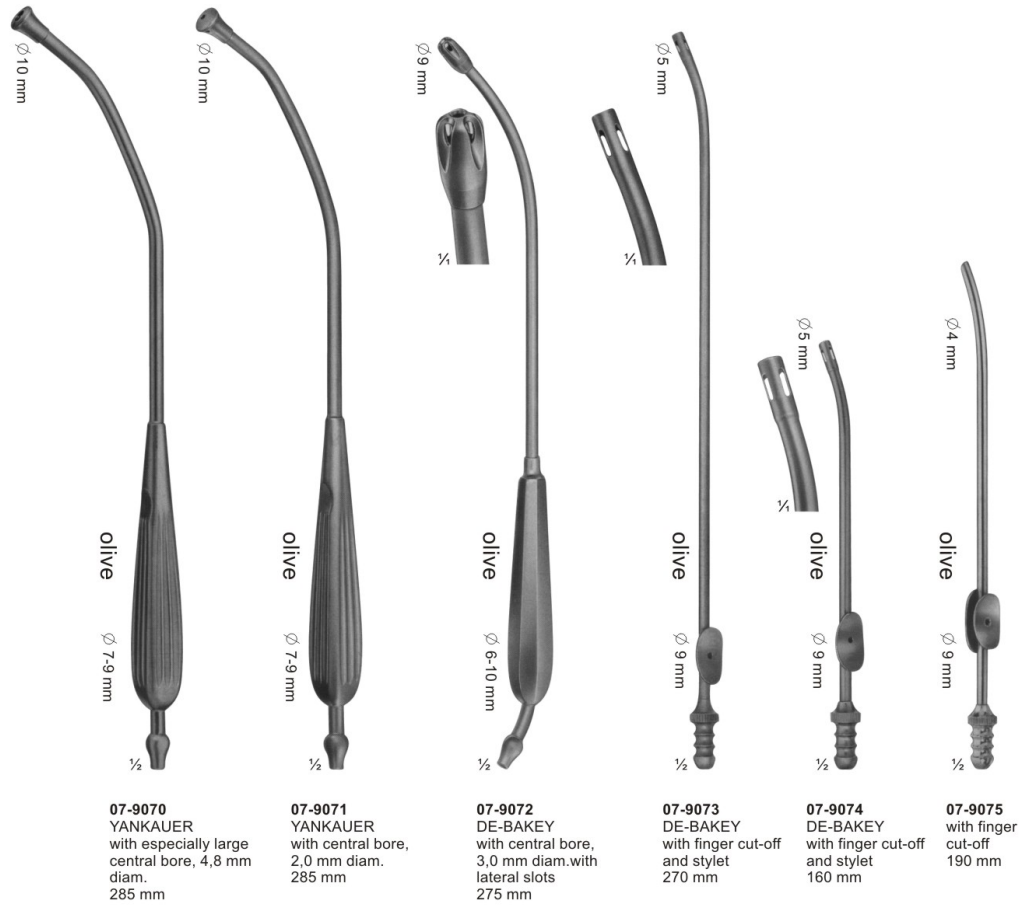

Suction Instruments

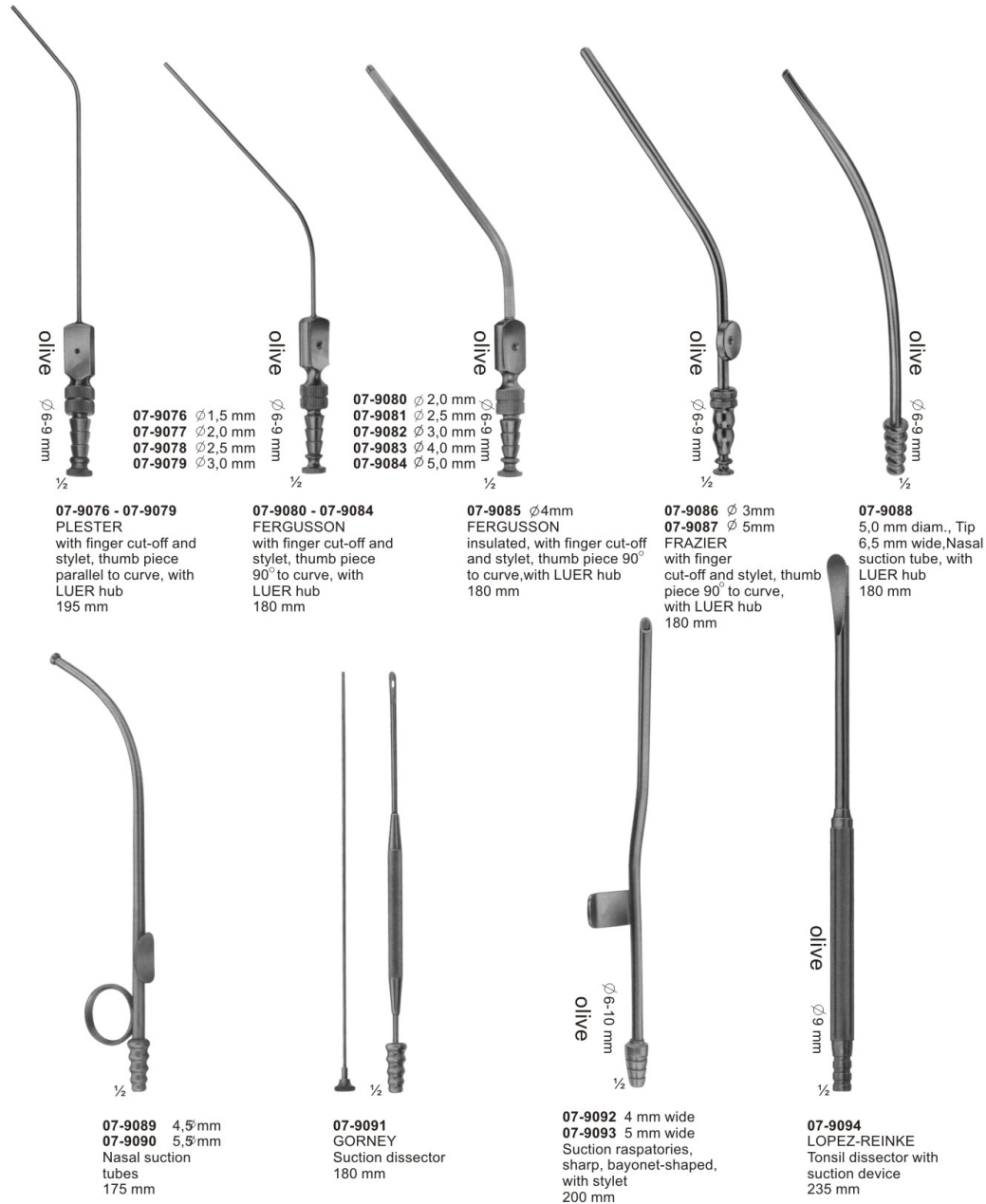

Suction Instruments

07-9095 \varnothing 1,75 mm \varnothing 3 mm
WULLSTEIN
Suction tube, conical, silver, olive
with LUER hub
160 mm
olive \varnothing 8 mm $\frac{1}{2}$

07-9096 1.5 mm
07-9097 2.0 mm
WULLSTEIN
Suction tube, cylindrical, silver, with
stylet olive with LUER hub
160 mm
olive \varnothing 8 mm $\frac{1}{2}$

Usable length

YASARGIL usable length diam.		YASARGIL usable length diam.	
07-9098	130 mm 1,5 mm	07-9106	130 mm 2,5 mm
07-9099	150 mm 1,5 mm	07-9107	150 mm 2,5 mm
07-9100	180 mm 1,5 mm	07-9108	180 mm 2,5 mm
07-9101	220 mm 1,5 mm	07-9109	220 mm 2,5 mm
07-9102	130 mm 2,0 mm	07-9110	130 mm 3,5 mm
07-9103	150 mm 2,0 mm	07-9111	150 mm 3,5 mm
07-9104	180 mm 2,0 mm	07-9112	180 mm 3,5 mm
07-9105	220 mm 2,0 mm	07-9113	220 mm 3,5 mm
		07-9114	180 mm 4,5 mm

olive \varnothing 6,5-9 mm with LUER hub $\frac{1}{2}$

07-9115 - 07-9117
LANDOLT
150 MM
diam \varnothing 3 mm

07-9115	8 mm / curved
07-9116	11mm / curved
07-9117	15mm / curved

\varnothing 3.5 mm \varnothing 2.0 mm

07-9118 500 mm
07-9119 350 mm
with rubber tip,
with LUER hub
olive \varnothing 9 mm $\frac{1}{2}$

07-9120 2.0 mm diam
07-9121 2.5 mm diam
07-9122 3.0 mm diam
with finger cut-off,
thumb piece 90° to
curve, with LUER hub
250 mm
olive \varnothing 6-9 mm $\frac{1}{2}$

**Combined Suction and Irrigation Cannulae,
Coagulation Suction Cannulae**

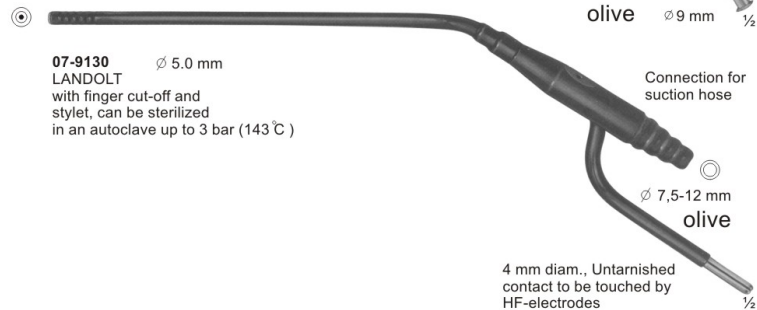
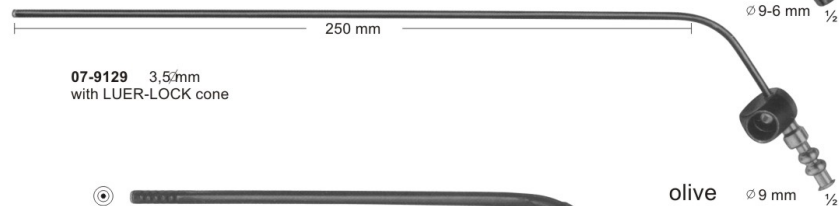
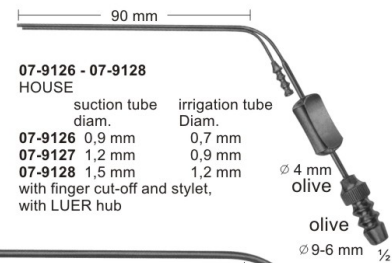
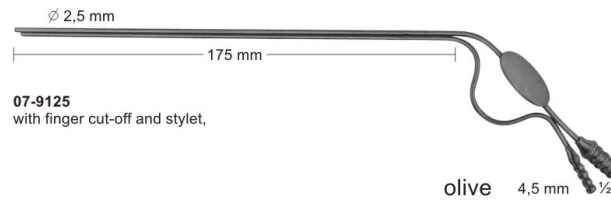
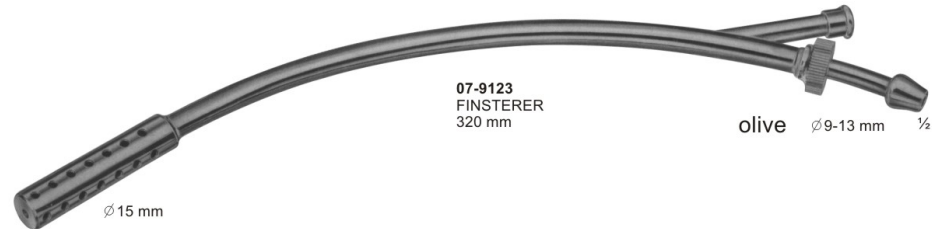

Scissors with Tungsten Carbide Inserts



07-9131 - 07-9133
STANDARD
07-9131 14,5cm
07-9132 16,5cm
07-9133 18,5cm



07-9134 - 07-9136
STANDARD
07-9134 14,5cm
07-9135 16,5cm
07-9136 18,5cm



07-9137 - 07-9139
STANDARD
07-9137 14,5cm
07-9138 16,5cm
07-9139 18,5cm



07-9140 - 07-9142
STANDARD
07-9140 14,5cm
07-9141 16,5cm
07-9142 18,5cm



07-9143 - 07-9145
STANDARD
07-9143 14,5cm
07-9144 16,5cm
07-9145 18,5cm



07-9146 - 07-9148
STANDARD
07-9146 14,5cm
07-9147 16,5cm
07-9148 18,5cm

Scissors with Tungsten Carbide Inserts

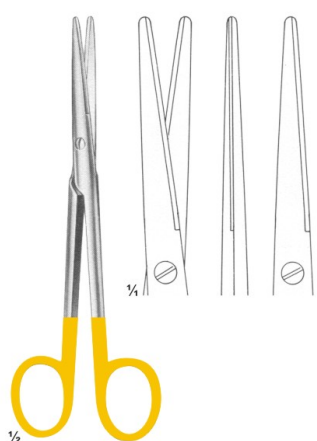

07-9149
MAYO-LEXER
16cm

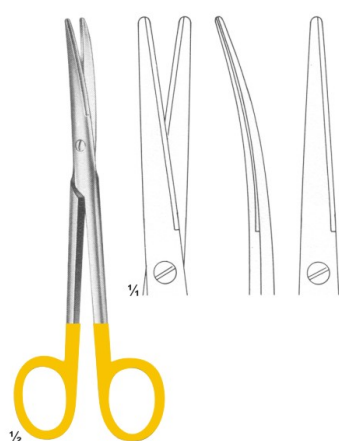

07-9150
MAYO-LEXER
16cm



07-9151 - 07-9152
LEXER
07-9151 16cm
07-9152 21cm

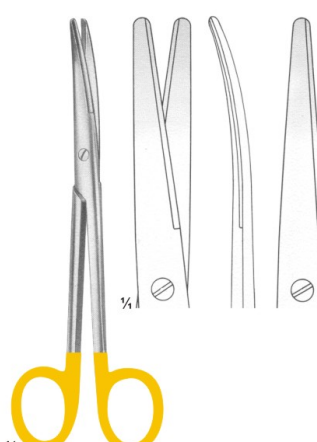

07-9153 - 07-9154
LEXER
07-9153 16cm
07-9154 21cm

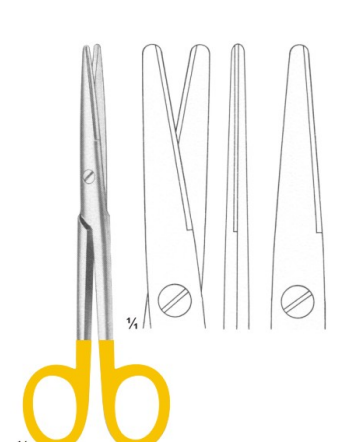

07-9155 - 07-9156
MAYO-STILLE
07-9155 15cm
07-9156 17cm

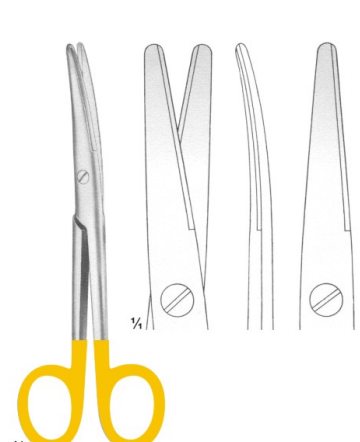

07-9157 - 07-9158
MAYO-STILLE
07-9157 15cm
07-9158 17cm

Scissors with Tungsten Carbide Inserts



07-9159 - 07-9160
METZENBAUM

07-9159 11.5cm
07-9160 14.5cm

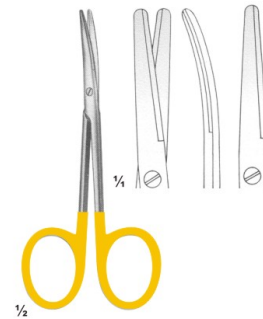

07-9161 - 07-9164
METZENBAUM

07-9161 11.5cm
07-9162 14.5cm
07-9163 23cm
07-9164 25cm

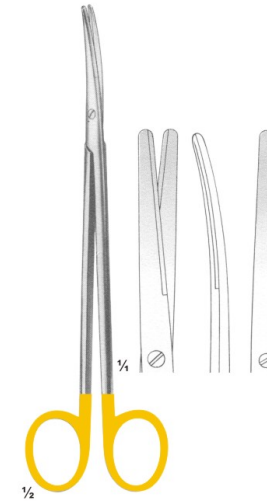

07-9165 - 07-9170
METZENBAUM

07-9165 18cm
07-9166 20cm
07-9167 23.5cm
07-9168 25.5cm
07-9169 28cm
07-9170 30cm

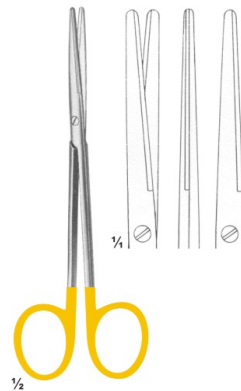

07-9171 - 07-9176
METZENBAUM-FINO

07-9171 14cm
07-9172 18cm
07-9173 20cm
07-9174 23cm
07-9175 25cm
07-9176 28cm

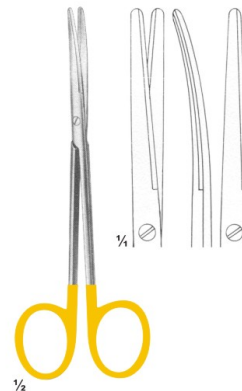

07-9177 - 07-9182
METZENBAUM-FINO

07-9177 14cm
07-9178 18cm
07-9179 20cm
07-9180 23cm
07-9181 25cm
07-9182 28cm

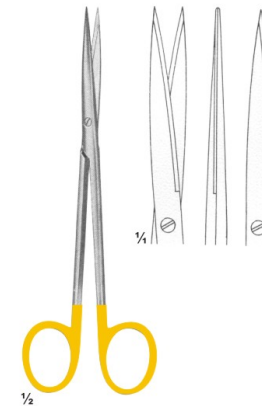

07-9183 - 07-9186
METZENBAUM-FINO

07-9183 14cm
07-9184 18cm
07-9185 20cm
07-9186 23cm

Scissors with Tungsten Carbide Inserts

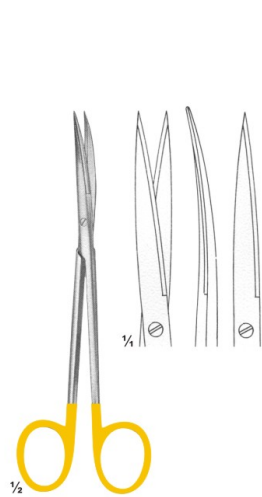

07-9187 - 07-9190
METZENBAUM-FINO

07-9187 14cm
07-9188 18cm
07-9189 20cm
07-9190 23cm

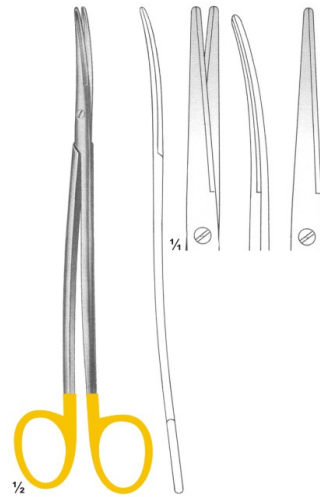

07-9191 - 07-9193
METZENBAUM-FINO

07-9191 18cm
07-9192 20cm
07-9193 23cm

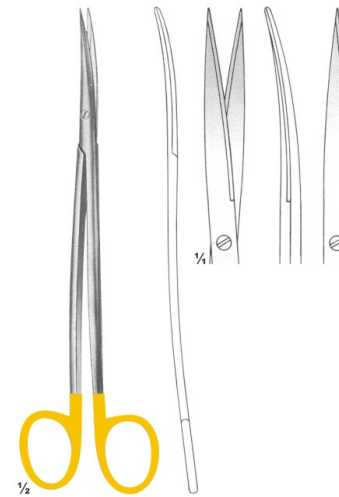

07-9194 - 07-9196
METZENBAUM-FINO

07-9194 18cm
07-9195 20cm
07-9196 23cm

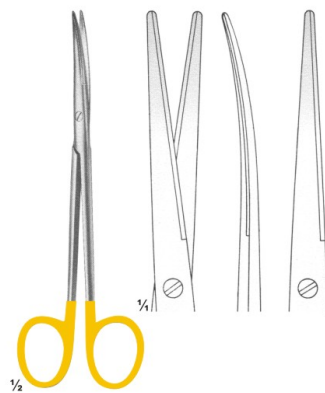

07-9197 - 07-9198
METZENBAUM

07-9197 20cm
07-9198 23cm

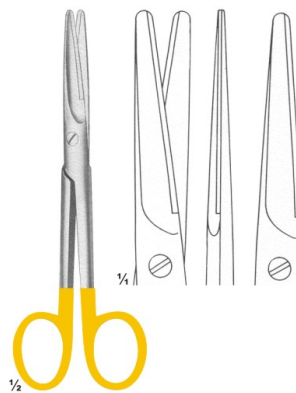

07-9199 - 07-9201
MAYO

07-9199 14.5cm
07-9200 17cm
07-9201 23cm



07-9202 - 07-9204
MAYO

07-9202 14.5cm
07-9203 17cm
07-9204 23cm

Scissors with Tungsten Carbide Inserts

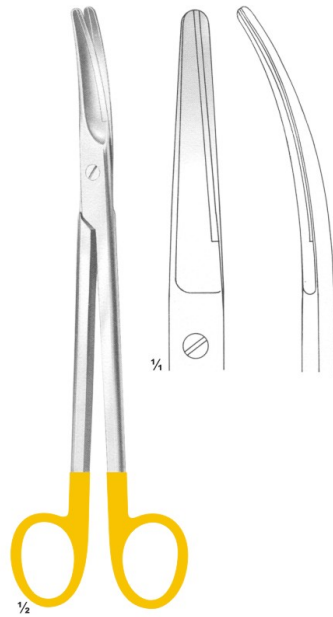

07-9205
WERTHEIM
Dissecting Scissors
23cm

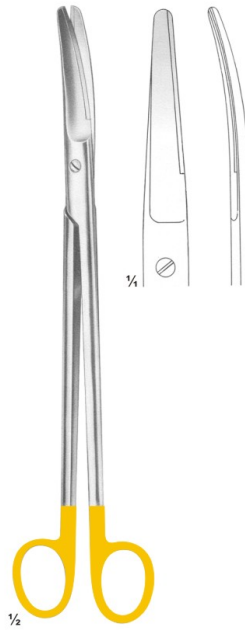

07-9206
SIMS
20cm
07-9207
23cm

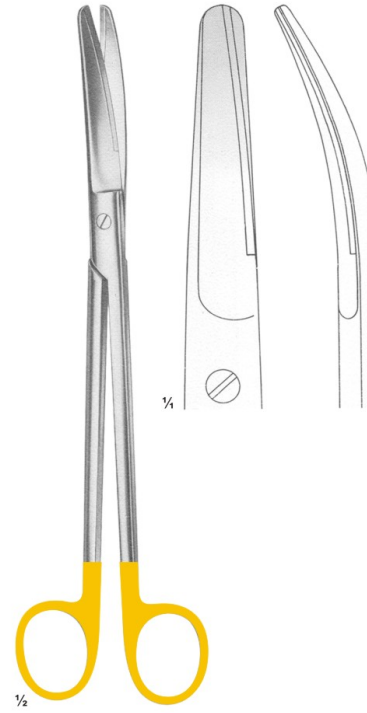

07-9208
MAYO-HARRINGTON
28cm

Scissors with Tungsten Carbide Inserts

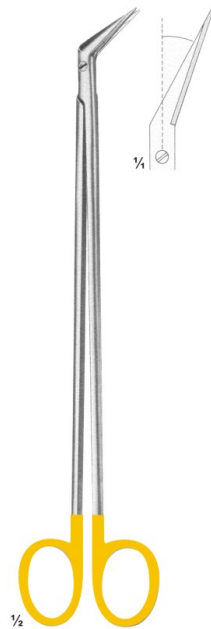

07-9209 - 07-9211
DE-BAKEY
(Potts-Smith)



07-9212 - 07-9214
DE-BAKEY
(Potts-Smith)

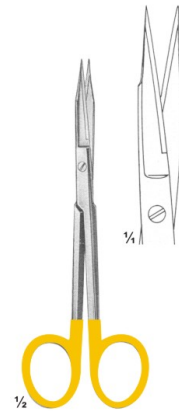

07-9215
GOLDMANN FOX
13cm

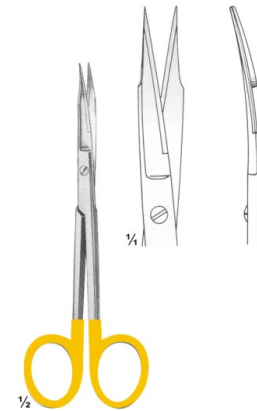

07-9216
GOLDMANN FOX
13cm

07-9209 23cm 25
07-9210 23cm 45
07-9211 23cm 60

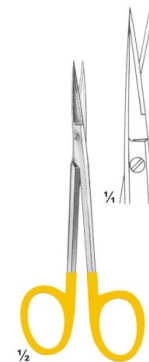

07-9217
Fine Scissor
11,5cm

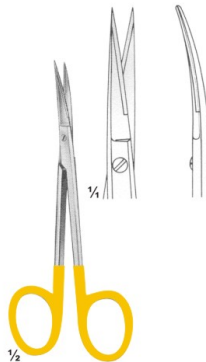

07-9218
Fine Scissor
11,5cm



07-9219
11,5cm



07-9220
RAGNELL (Kilner)
12cm

Scissors & Dissecting Forceps with Tungsten Carbide Inserts

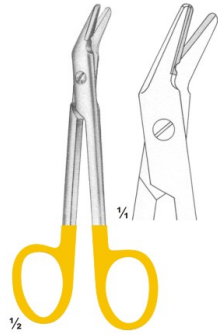

07-9221
UNIVERSAL
12cm



07-9222 - 07-9224
SUTURE SCISSORS
1 Black & 1 Gold Plated ring

07-9222 14cm
07-9223 17cm
07-9224 23cm

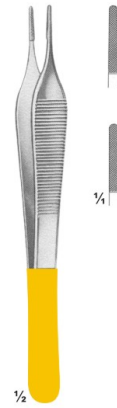

07-9225 - 07-9226 ADSON
07-9225 12cm
07-9226 15cm



07-9227
CUSHING
With dissector end
17,5cm



07-9228
CUSHING
With dissector end
18cm



07-9229
CUSHING-TAYLOR
18cm



07-9230
DISSECTING FORCEPS
15cm



07-9231
SEMKEN
15cm

**Dissecting Forceps and Needle holders with
Tungsten Carbide Inserts**

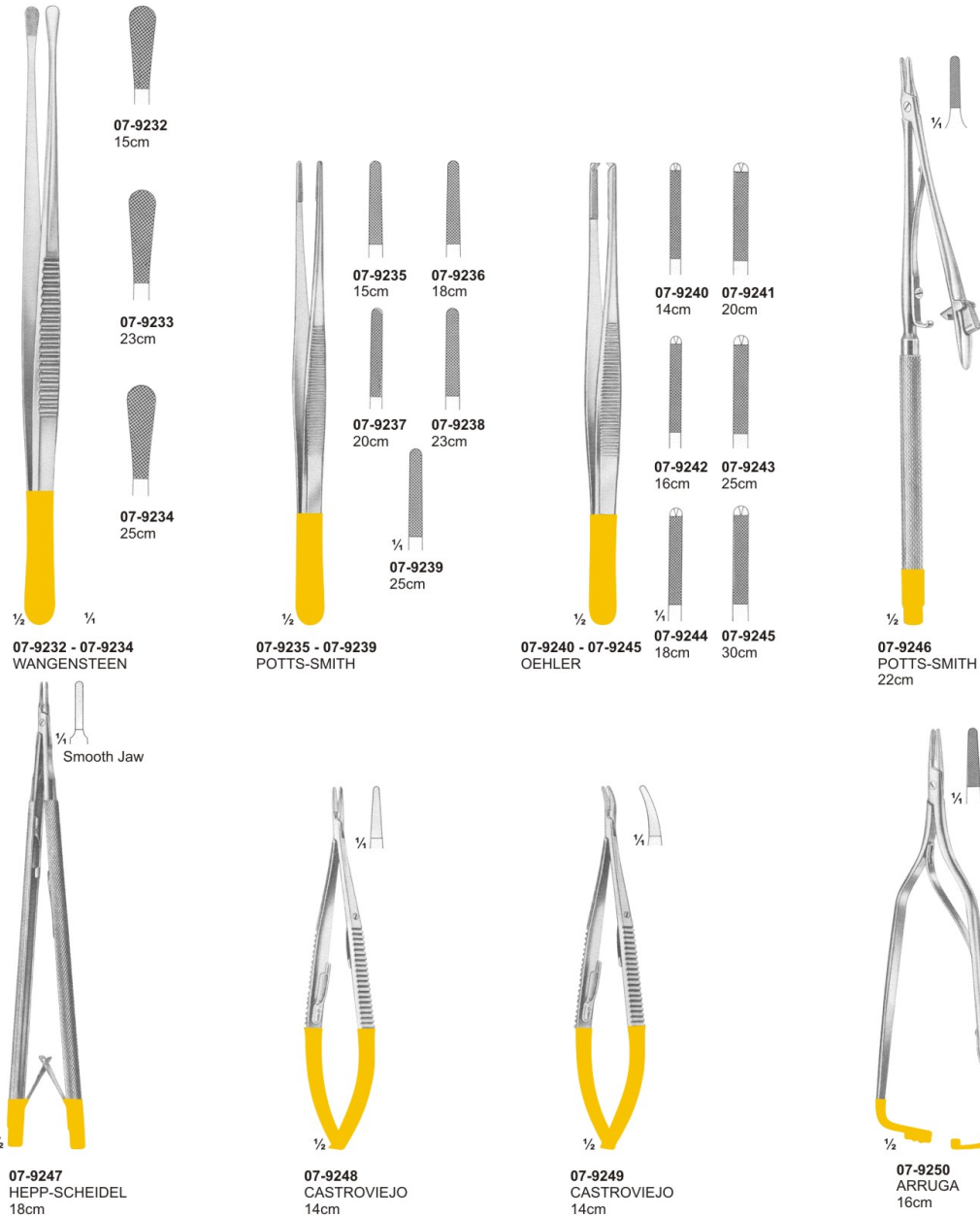

Needle holders with Tungsten Carbide Inserts



07-9251
ARRUGA
16cm



07-9252
CASTROVIEJO
13cm



07-9253 07-9254
20cm 24cm

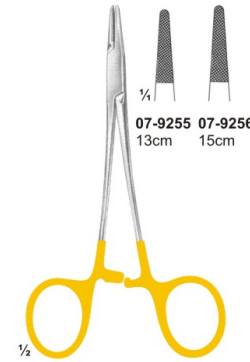

07-9255 07-9256
13cm 15cm

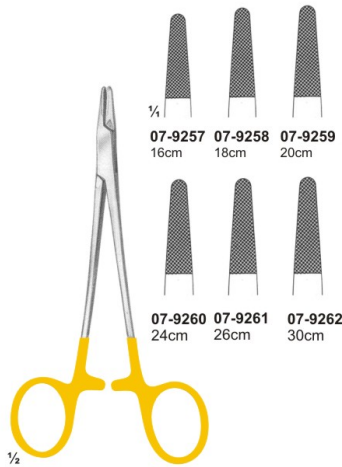

07-9257 - 07-9262
MAYO-HEGAR

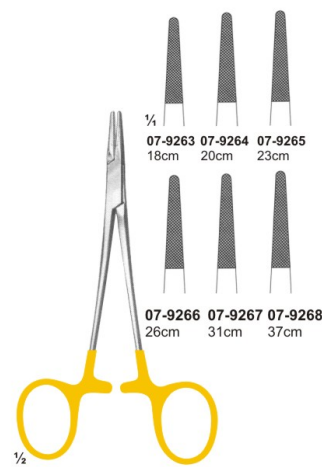

07-9263 - 07-9268
DE-BAKEY

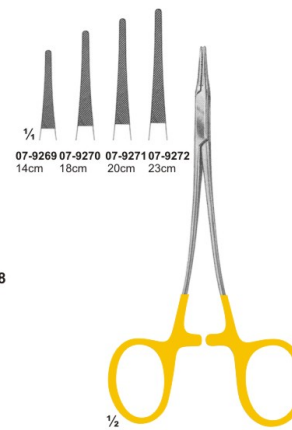

07-9269 - 07-9272
HEGAR-VASCULAR

Needle holders with Tungsten Carbide Inserts

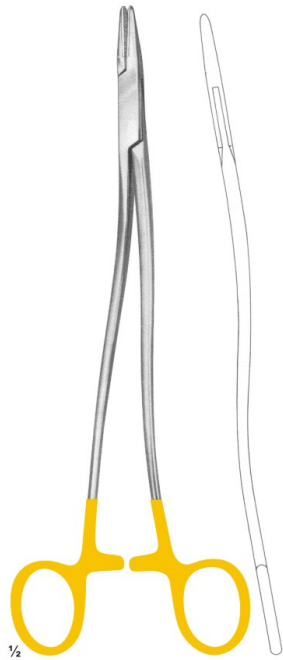

07-9273 - 07-9275
BOZEMANN

07-9273	20cm
07-9274	24cm
07-9275	26cm

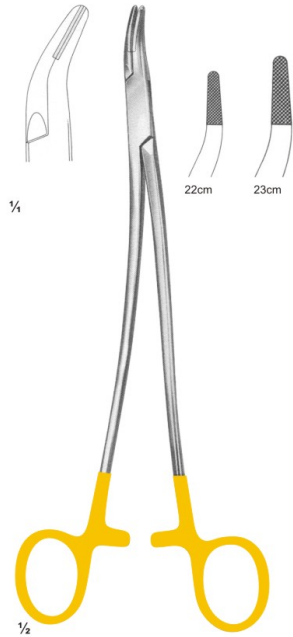

07-9276 - 07-9277
STRATTE

07-9276	22cm
07-9277	23cm

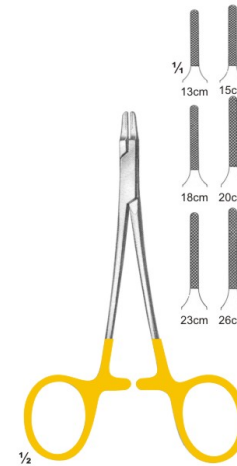

07-9278 - 07-9283
RYDER

07-9278	13cm
07-9279	15cm
07-9280	18cm
07-9281	20cm
07-9282	23cm
07-9283	26cm

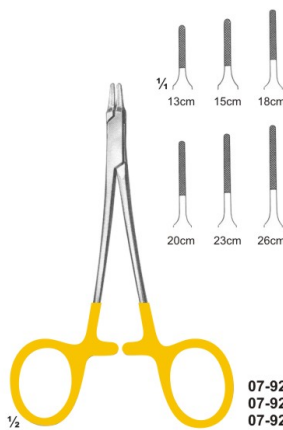

07-9284 - 07-9288
RYDER-VASCULAR

07-9284	13cm
07-9285	15cm
07-9286	20cm
07-9287	23cm
07-9288	26cm



07-9289 - 07-9291
MARTIN

07-9289	15cm
07-9290	17cm
07-9291	20cm

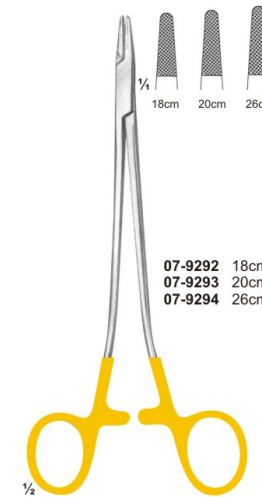

07-9292 - 07-9294
SAROT

07-9292	18cm
07-9293	20cm
07-9294	26cm

Needle holders with Tungsten Carbide Inserts

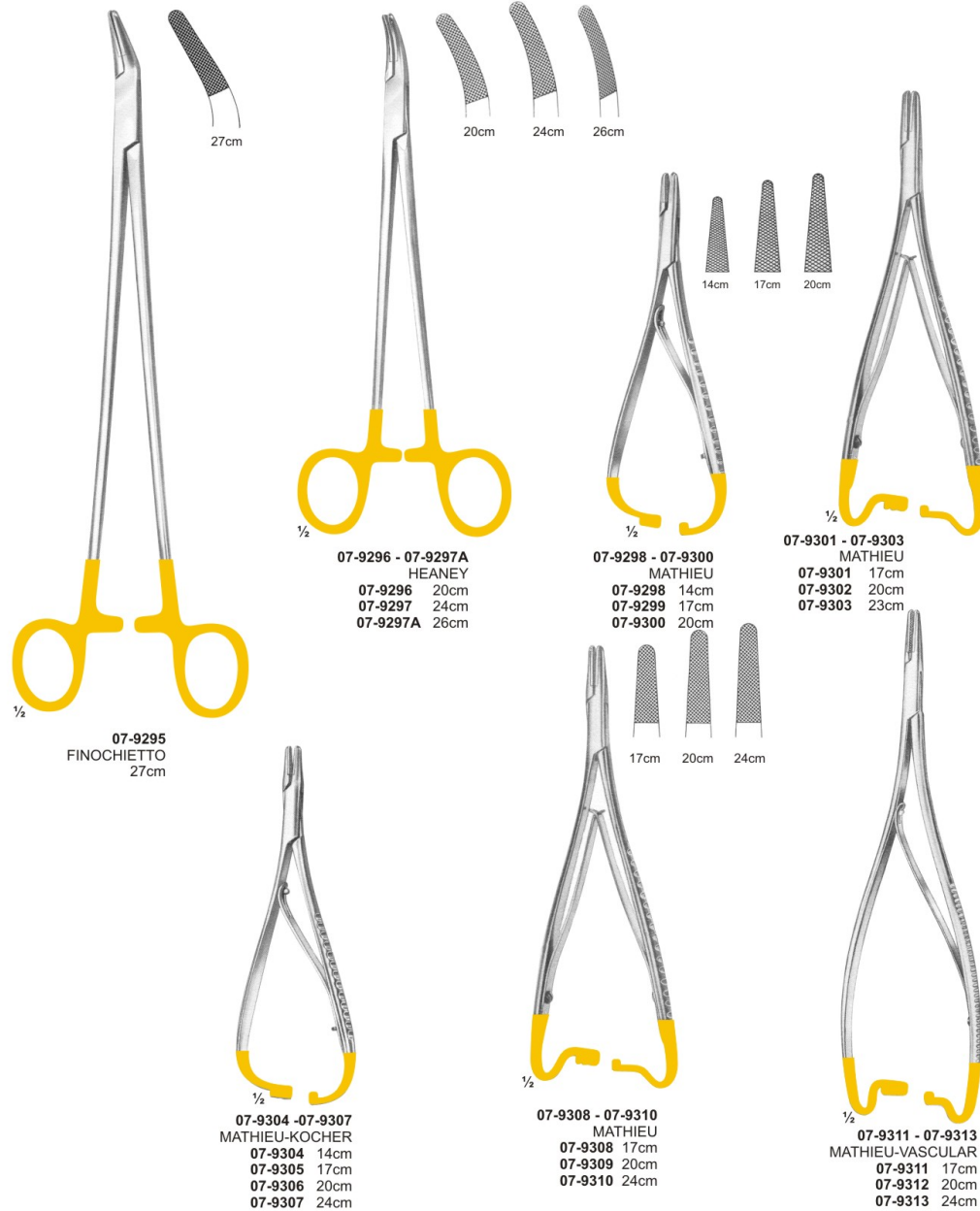

Needle holders with Tungsten Carbide Inserts

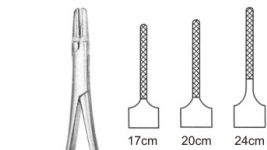

07-9314 - 07-9316
MATHIEU-RYDER
07-9314 17cm
07-9315 20cm
07-9316 24cm



07-9317
LICHTENBERG
20cm

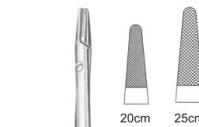

07-9318 - 07-9319
LANGHALS
07-9318 20cm
07-9319 25cm

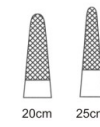

07-9320 - 07-9321
LICHTENBERG
07-9320 20cm
07-9321 25cm

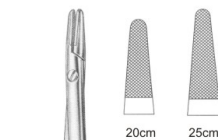

07-9322 - 07-9323
LUETHY-BECK
07-9322 20cm
07-9323 25cm



07-9324 - 07-9325
LUETHY-BECK
07-9324 20cm
07-9325 25cm



07-9326 - 07-9328
LANGENBECK
07-9326 18cm
07-9327 20cm
07-9328 23cm



07-9329 - 07-9331
LANGENBECK
07-9329 18cm
07-9330 20cm
07-9331 23cm

**Needle holders with Tungsten Carbide
Inserts and Without TC**



07-9332
STEVENS
15 cm



07-9333
KALT
14 cm



07-9334
KALT "HM"
14 cm

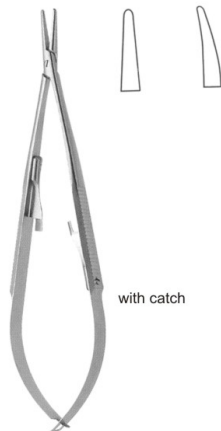

07-9335 - 07-9338
CASTROVIEJO
07-9335 14 cm STR
07-9336 17 cm STR
07-9337 14 cm CVD
07-9338 17 cm CVD



07-9339 - 07-9340
CASTROVIEJO
07-9339 14 cm
07-9340 17 cm



07-9341
CASTROVIEJO "HM"
13 cm

Needle holders with Tungsten Carbide Inserts and Without TC



07-9342 - 07-9345
CASTROVIEJO "HM"
07-9342 14 cm smooth
07-9343 17 cm smooth
07-9344 14 cm serrated
07-9345 17 cm serrated



07-9346 - 07-9347
CASTROVIEJO-MICRO
14, 5 cm
07-9346 14.5 cm STR
07-9347 14.5 cm CVD



07-9348 - 07-9349
CASTROVIEJO-MICRO
14, 5 cm
07-9348 14.5 cm STR
07-9349 14.5 cm CVD

Ultra Fine



07-9350 - 07-9351
CASTROVIEJO
(KOSHIMA)
14, 5 cm
07-9350 14.5 cm STR
07-9351 14.5 cm CVD



07-9352 - 07-9353
CASTROVIEJO
(KOSHIMA)
14, 5 cm
07-9352 14.5 cm STR
07-9353 14.5 cm CVD

**Needle holders with Tungsten Carbide Inserts
and Without TC**



07-9354 - 07-9355
BARRAQUER
07-9354 11,5 cm
07-9355 14 cm



07-9356 - 07-9357
BARRAQUER
07-9356 11,5 cm
07-9357 14 cm



07-9358 - 07-9359
JACOBSON "HM"
07-9358 18,5 cm
07-9359 21 cm



07-9360 - 07-9361
JACOBSON "HM"
07-9360 18,5 cm
07-9361 21 cm



07-9362 - 07-9363
JACOBSON
07-9362 18,5 cm
07-9363 21 cm



07-9364 - 07-9365
JACOBSON "HM"
18 cm
07-9364 18 cm STR
07-9365 18 cm CVD



07-9366 - 07-9367
JACOBSON "HM"
18 cm
07-9366 18 cm STR
07-9367 18 cm CVD

Micro Needle Holders



07-9368 - 07-9369
MICRO 2000
12 cm
07-9368 12 cm STR
07-9369 12 cm CVD



07-9370 - 07-9371
MICRO 2000
12 cm
07-9370 12 cm STR
07-9371 12 cm CVD



07-9372
MICRO 2000
15 cm



07-9373 - 07-9374
MICRO 2000
15 cm
07-9373 15 cm STR
07-9374 15 cm CVD



07-9375 - 07-9376
YASARGIL
16 cm
07-9375 16 cm STR
07-9376 16 cm CVD

Wire Cutting Plier With T.C. Inserts



07-9377
TOENNIS
Elastic pattern for
dura-or intestinal suture
180 mm

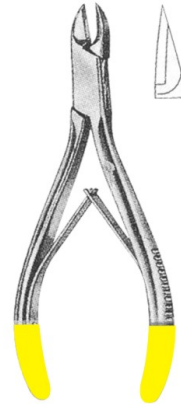

07-9378
Cutting Plier
12 cm

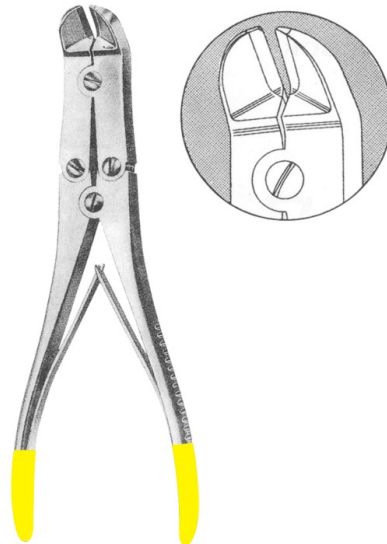

07-9379
MULLAR CLAUS
Plier
22 cm



07-9380
Plier
17.5 cm

Dressing Sterilizing Drums, Storing Cases and Needle Cases



07-9381 - 07-9395
SCHIMMELBUSCH
without filter laterally
perforated lockable
by sliding mechanism.

	Ø x H sizes in mm
07-9381	80 x 80
07-9382	105 x 120
07-9383	140 x 140
07-9384	160 x 120
07-9385	160 x 150
07-9386	190 x 150
07-9387	190 x 190
07-9388	240 x 160
07-9389	240 x 240
07-9390	290 x 160
07-9391	290 x 240
07-9392	340 x 160
07-9393	340 x 340
07-9394	390 x 190
07-9395	390 x 290



07-9396
BOX
120 x 65 x 13mm
(without Bulldog clamps,
without silicone tape)

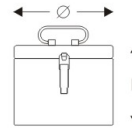

07-9397 - 07-9409
KONRICH

	Ø x H sizes in mm
07-9397	100 x 100
07-9398	150 x 150
07-9399	200 x 150
07-9400	200 x 190
07-9401	240 x 160
07-9402	240 x 230
07-9403	290 x 160
07-9404	290 x 240
07-9405	340 x 160
07-9406	340 x 240
07-9407	390 x 145
07-9408	390 x 240
07-9409	390 x 290



07-9410
Box with support for
needle electrodes,
without instruments

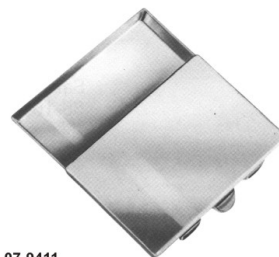

07-9411
50 x 25 x 4,5 mm
07-9412
65 x 42 x 8 mm
07-9413
75 x 25 x 4,5 mm



07-9414
Box with support
120 x 65 x 13 mm
(with bulldog clamps)

07-9415
Ø 62mmx13mm
Interior box
perforated lid
and bottom.

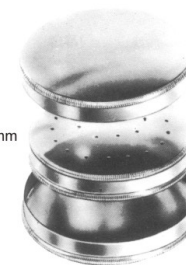

07-9416
complete with perforated
interior box.
Ø 65mm x 15mm

Jars and Instrument boxes

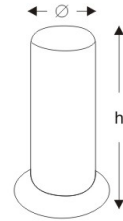

Ø x H	Jar without lid	lid only	lid only with triangle hole
30x90mm	07-9417	07-9426	07-9435
50x100mm	07-9418	07-9427	07-9436
50x130mm	07-9419	07-9428	07-9437
50x175mm	07-9420	07-9429	07-9438
75x100mm	07-9421	07-9430	07-9439
75x130mm	07-9422	07-9431	07-9440
75x175mm	07-9423	07-9432	07-9441
100x175mm	07-9424	07-9433	07-9442
100x200mm	07-9425	07-9434	07-9443

07-9417 - 07-9443



07-9444 - 07-9467

L x B x H	Lid with knob	Lid without knob
07-9444 165 x 85 x 35 mm	07-9452	07-9460
07-9445 200 x 100 x 35 mm	07-9453	07-9461
07-9446 200 x 100 x 50 mm	07-9454	07-9462
07-9447 230 x 130 x 50 mm	07-9455	07-9463
07-9448 260 x 150 x 50 mm	07-9456	07-9464
07-9449 270 x 235 x 50 mm	07-9457	07-9465
07-9450 300 x 200 x 50 mm	07-9458	07-9466
07-9451 325 x 275 x 50 mm	07-9459	07-9467



07-9468
205 x 105 x 35 mm

Dressing Forceps in Jar with Cap



07-9469 - 07-9470

- 07-9469** Sterilizing Forceps
consisting of:
1 Sterilizing Forceps, curved, 25 cm,
without ratchet, with lid for jar
1 jar with wide bottom plate (anti-tilt)
- 07-9470** ditto, with 32 cm long Sterilizing Forceps

Round Metal Boxes, Medicine Cups and Kidney Dishes



Lid with knob

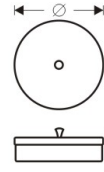

07-9471 - 07-9477

Ø x H

07-9471	75 x 60 mm
07-9472	75 x 75 mm
07-9473	100 x 60 mm
07-9474	100 x 100 mm
07-9475	125 x 80 mm
07-9476	125 x 125 mm
07-9477	150 x 150 mm



07-9478
25 cc
graduated
inside

07-9479
50 cc
graduated
inside



07-9480
20 cc
Medicine Spoon
graduated
inside



07-9481
Ø75 x 12 mm
Tablet Tray



07-9482
Ø90 x 90 mm
Metal Cup



07-9483
Ø75 x 80 mm
Sputum Cup

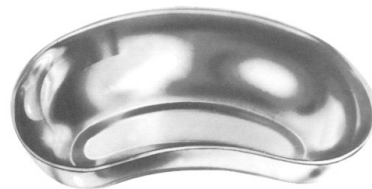

Kidney Dish



Lid for kidney dishes

07-9484 - 07-9486

L x B x H

07-9484	170 x 100 x 35 mm
07-9485	250 x 140 x 40 mm
07-9486	275 x 150 x 45 mm

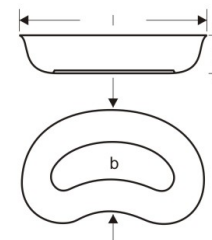

Round Bowls, Graduated Measures and Trays



07-9487 - 07-9494

	∅ x H		
07-9487	40 x 19 mm	0.05L	
07-9488	61 x 30 mm	0.07L	
07-9489	80 x 40 mm	0.14L	
07-9490	116 x 50 mm	0.35L	
07-9491	128 x 55 mm	0.45L	
07-9492	147 x 65 mm	0.70L	
07-9493	167 x 75 mm	1.10L	
07-9494	187 x 85 mm	1.60L	



07-9495 - 07-9499

	∅ x H		
07-9495	116 x 35 mm	0.30L	
07-9496	128 x 38 mm	0.40L	
07-9497	147 x 40 mm	0.50L	
07-9498	157 x 45 mm	0.75L	
07-9499	187 x 45 mm	1.00L	



07-9500
∅ 110 x 28 mm 0.15L



07-9501
100 cc = 0.1L
graduated
inside



07-9502 - 07-9505

07-9502	0.25L
07-9503	0.50L
07-9504	1.00L
07-9505	2.00L

graduated
inside



07-9506
235 x 190 x 40 mm



07-9507
∅ 220 x 70 mm

**Powder Strewer, Triangular Basins,
Placenta and Bed Pans**



07-9508
∅ 50 x 100 mm
Powder Pot



07-9509
∅ 50 x 75 mm
Methot With Lid



07-9510
∅ 50 x 75 mm
Methot Without Lid



graduated inside upto 600ml with handle
07-9511

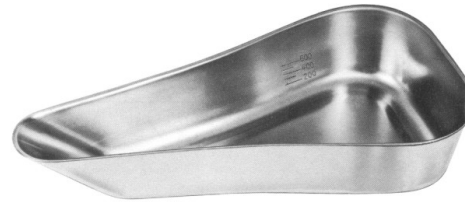

graduated inside upto 600ml
07-9512



07-9513
PLACENTA PAN

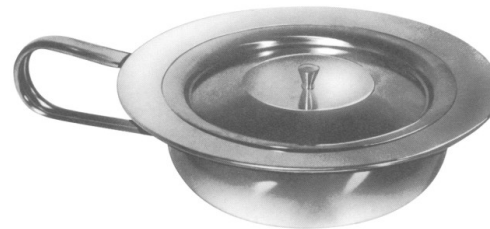

07-9514 - 07-9515
BED PAN
07-9514 ∅ 235 mm
07-9515 ∅ 310 mm

Needle Sterilizing Cases



07-9516
Sauerbruch
210 x 125 x 17 mm
perforated lid and
bottom



07-9517
Sauerbruch
210 x 125 x 17 mm
perforated lid and
bottom



07-9518
150 x 95 x 13 mm



07-9519
150 x 95 x 13 mm
perforated lid and
bottom



07-9520
150 x 95 x 13 mm
perforated bottom



07-9521
150 x 95 x 13 mm
perforated lid and
bottom



07-9522
150 x 95 x 13 mm



07-9523
150 x 95 x 13 mm
perforated lid and
bottom



07-9524
150 x 95 x 11 mm
Needle tray perforated
bottom

**Storing Cases Perforated Bottom with
Textile Filter**



07-9525
Deponette
245 x 135 x 35mm

Perforated bottom,
with textile filter ref.



07-9526
Deponette
245 x 135 x 50mm

Perforated bottom,
with textile filter ref.



07-9527
Deponette
245 x 135 x 60mm

Perforated bottom,
with textile filter ref.



Perforated Bottom

Universal Trays and Storing Cases

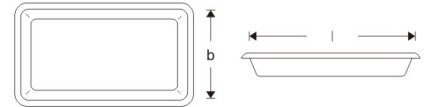

07-9528 - 07-9532

satin finish	size in mm l x b x h
07-9528	230 x 165 x 30
07-9529	300 x 155 x 30
07-9530	300 x 175 x 40
07-9531	350 x 240 x 36
07-9532	400 x 300 x 50

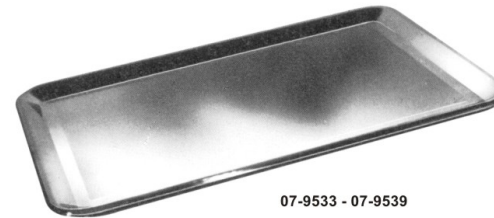

07-9533 - 07-9539

satin finish	size in mm ∅ x H
07-9533	210 x 160 x 10
07-9534	240 x 180 x 10
07-9535	310 x 150 x 10
07-9536	310 x 210 x 10
07-9537	350 x 240 x 10
07-9538	400 x 270 x 20
07-9539	420 x 280 x 10



07-9540 - 07-9550

	L x H x B mm
07-9540	230 x 130 x 50
07-9541	260 x 150 x 50
07-9542	275 x 235 x 50
07-9543	300 x 200 x 50
07-9544	325 x 275 x 50
07-9545	420 x 175 x 50
07-9546	230 x 130 x 75
07-9547	260 x 150 x 75
07-9548	300 x 200 x 75
07-9549	325 x 275 x 75
07-9550	420 x 175 x 75

Sterilizing Baskets / Trays

Sterilizing tray of wire mesh
for container 30cm long

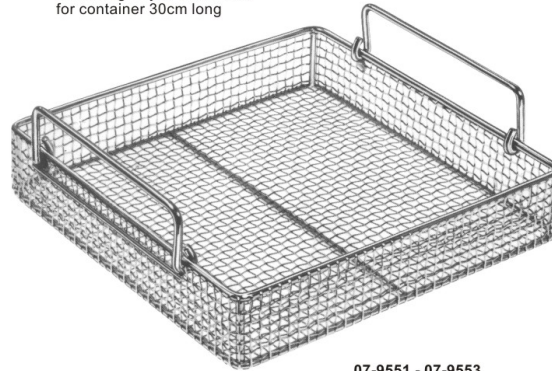

07-9553
250 x 250 x 50mm

07-9551 480 x 250 x 50 mm
07-9552 520 x 250 x 75 mm
07-9553 520 x 250 x 100 mm
Sterilizing Trays of wire mesh
for container 60cm long.

07-9551 - 07-9553



Sterilizing tray of perforated steel sheet **07-9554 - 07-9559**

07-9554 240 x 240 x 50 mm
07-9555 240 x 240 x 80 mm
07-9556 240 x 240 x 100 mm
07-9557 480 x 260 x 50 mm
07-9558 520 x 260 x 80 mm
07-9559 520 x 260 x 100 mm

Sterilizing Basket

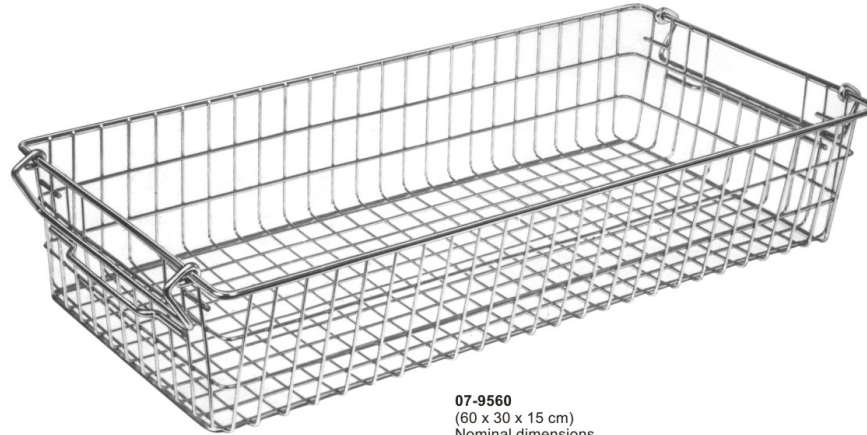

07-9560
(60 x 30 x 15 cm)
Nominal dimensions

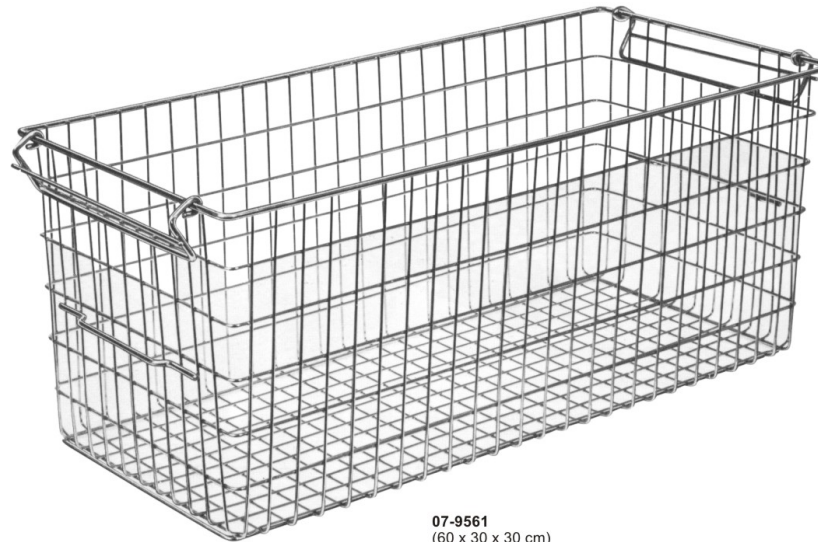

07-9561
(60 x 30 x 30 cm)
Nominal dimensions

ALPHABETICAL INDEX

A

Abdominal Blades	163	Baby-Mixer Forceps	87
Retractors	144-147, 162-164-167	Baby-Mosquito , Delicate Haemostatic Forceps	79
Abraham Tonsil Knife	17	Baby-Nail Scissors	49
Adson Delicate Haemostatic Forceps	80	Baby-Overholt Forceps	87
Dissecting Forceps	55,62,411	Baby-Roux Retractors	123
Needle Holders	98	Baby-Senn-Miller Retractors	123
Raspatories	334	Backhaus Towel Clamps	75
Retractors	155-156	Backhaus-Kocher Towel Clamps	75
Adson-Baby Self-Retaining Retractors	154	Bailey Rib Spreaders and Contractors	307
Adson-Brown Tissue Forceps	63	Bainbridge Intestinal Clamps	173
Aesthesiometers	1	Bakes Common Bile Duct Dilators	198
Alexander Bone Rongeurs	367	Balfour Abdominal Retractors	165
Gouges	353	Balfour-Baby Abdominal Retractors	164
Rib Raspatories	299	Bandage Cutting Scissors	49-51,393,394
Organ Grasping Forceps	74	Bane-Hartmann Bone Rongeurs	366
Retractors	151	Barraquer Micro Needle Holders	97,419
Sponge Forceps	68	Retractors	151
Allen Intestinal Clamps	173	Barth Bone Curettes	342
Allis Artery Traction Forceps	73	Bayonet Shaped Forceps	53-54,61
Intestinal Grasping Forceps	171	Bumgartner Needle Holders	98
Lung Grasping Forceps	290	Beckmann-Adson Retractors	156
Tissue Grasping Forceps	168	Beckmann-Eaton Retractors	156
Allison Lung Spatulas	138,309	Beebe Wire and Plate Scissors	48
ALY Aesthesiometers	1	Beer Cilia Forceps	66
Amputation Knives	16,319	Bed Pans	426
Retractors	320	Bending Pliers	387
Saws	321-322	Bengolea Delicate Haemostatic Forceps	81
Anastomosis Clamps	184-186,265-266, 269-270,275-276, 285-286	Bennett Bone Levers	330
	155	Berger Biopsy Forceps	240
Anderson-Adson Retractors	5	Bergh Cilia Forceps	66
Andrew Tongue Depressors	2	Bergmann Mallets	350
Anestophon Stethoscope	388	Plaster Scissors	394
Angle Wire Cutters	208	Trachea Retractors	118
Antrum Trocars	189	Berliner Percussion Hammer	1
Anuscopes	280-281,288	Bertillon Caliper for Head	11
Aorta Clamps	282	Bethune Rib Shears	296
Aorta-Anastomosis Clamps	278-279	Beyer Bone Rongeurs	367
Aorta-Aneurysm Clamps	276-277	Biemer Curettes for Aspiration Lipectomy	398
Aorta Cross Clamps	260	Vein Scissors	24
Aortic Dilators	182	Bier Amputation Saws	322
Appendectomy Clamps	235	Bircher Meniscus and Cartilage Forceps	377
Apprex Elevating Forceps	62	Bircher-Ganske Meniscus & Cartilage Forceps	377
Arruga Forceps	96,412,413	Biopsy Curettes	237
Needle Holders	73	Forceps	238-240
Artery Traction Forceps	237	Forceps For Rectum	190-191
Asch Secretion Curette/Scoop	398	Biopsy Instruments	237-240
Aspiration Curettes	34	Tips	240
Ateriotomy Scissors	339	Bioptome	260
Aufricht Bone Rasps	52	Bishop-Harmon Forceps	62
Austin Micro Forceps	13,16	Blade Breakers	19
Autopsy Knives	294	Bladder Retractors	204
Auricle Clamps	218	Spatula	204
Auvard Vaginal Speculums	17	Blake Embolus Grasping Forceps	257
Ayre Cone Knife		Gall Duct Dilators	198
		Gall Stone Forceps	199
		Uterine Curettes	242
		Blood Lancet	7
		Blumenthal Bone Rongeurs	366
		Bohler Bone Cutting Forceps	374
		Bone Rongeurs	368
		Traction Bows	382
		Bonaccollo Forceps	55
		Bone Clamps	364
		Curettes	342-347
		Cutting Forceps	297,373-376
		Files	399-341
		Holding Forceps	358-363
		Levers	324-330
		Rasps	339-341
		Retractors	125
		Rongeurs	365-372
Babcock Intestinal Grasping Forceps	169,171		
Lung Grasping Forceps	290		
Baby-Adson Forceps	87		
Baby-Allis Artery Traction Forceps	73		
Baby-Allis Tissue Grasping Forceps	168		
Baby-Collin Abdominal Retractors	162		
Baby-Crile Delicate Haemostatic Forceps	80		
Baby-Kocher Intestinal Clamps	173		
Baby-Metzenbaum Scissors	38		
Baby-Mikulicz Peritoneum Forceps	91		

B

ALPHABETICAL INDEX

E

Echlin Bone Rongeurs	369
Eiselsberg Ligature Scissors	47
Needle Holders	100
Eiselsberg-Mathieu Needle Holder	101
Elevators	258,299,324, 331-336
Elsching Forceps	62
Embolus Grasping Forceps	257
Emmet Fistula Hooks	121
Sponge and Dressing Forceps	69
Empyema Trocars	208
Endarterectomy Strippers	259
Endospecula For Cervix	223
Engel Plaster Saw	393
Engl. Mod. Towel Clamps	75
Enucleation Scissors	35
Episiotomy Scissors	45,248
Eppendorf Biopsy Forceps	240
Esmarch Bandage & Plaster Scissors	51,394
Plaster Knife	393
Ether Mask	6
Examination and Measuring Instruments	11
Exploration Hooks	116
Extension Cannulae	240
Cord	4
Extraction Pliers	387
Eye Scissors	23

F

Farabeuf Bone Holding Forceps	360
Raspatories	336
Retractors	123
Farabeuf-Lambotte Bone Holding Forceps	360
Farrell Cotton Applicators	109,110
Faure Biopsy Forceps	238
Peritoneum Forceps	91
Favoloro Artery Scissors	39
Feilchenfeld Splinter Forceps	66
Female Catheters Urinary Instruments	206
Femur Retractor	157
Fergusson Bone Holding Forceps	359
Haemorrhoidal Forceps	193
Suction Tube	402
Fergusson-Ackland Mouth Gag	6
Ferris-Smith-Kerrison Punches	312
Fiber Optic Batery Handle	10
Fine Scissors	33,34,410
Finger Nail Drill	392
Nail Instruments	392
Ring Saw	392
Finochietto Dissecting & Ligature Forceps	89,291
Needle Holders	415
Rib Spreaders	300,301
Finochietto-Burford Rib Spreaders	302
Finsen Self-Retaining Retractors	151
Finsterer Combined Cannulae	404
Fishtail Chisel	353
Fistula Hooks	121
Fixation Clamp	380
Discs	381
Flap Knives	16
Flat Nosed Pliers	386,387
Foerster-Ballenger Sponge Holding Forceps	70
Fomon Dissecting Scissors	35
Forceps	60-61
Nasal Scissors	41
Rasps/Bone File	340
Retractors	120

Forceps	52-66
With Tungsten Carbide Inserts	411-412
Ford-Bowles Stethoscopes	2
Fogger Laryngoscopes	10
Fowler Tonsil Knife	17
Francke Blood Lancet	7
Frazier Fine Wound Retractors	117
Suction Tube	402
Freer Chisels	351
Fine Wound Retractors	117
Gouges	351
Raspatories	332,333
Vascular Spatulas	258
Freer-Yasargil Raspatories	333
Frenzel Tongue Depressors	5
Fricke Artery Forceps	58,82
Fritsch Retractors	146

G

Gall Bladder Forceps	196
Trocars	208
Gall Duct Dilators	198
Forceps	194-195
Probes	197
Scissors	196
Gall Stone Forceps	199
Scoops	198
Gallaher Bone File	339
Gastro-Intestinal Forceps	181
Gauss Scalp Flap Forceps	251
Gelpi Retractors	157
Vaginal Retractors	220
Genito-Urinary Instruments	205-207
Gerald Dissecting Forceps	56
Tissue Forceps	64
Gerster Bone Clamps	364
Giertz- Stille Rib Shears	296
Gigli Wire Saws and Handle	323
Gill Forceps	62
Gill-Hess Forceps	62
Gillies Fine Wound Retractors	117
Needle Holders	100
Tissue Forceps	64
Glass Rods	236
Glover Anastomosis Clamps	269,270
Bulldog Clamps	78
Vena Cava Clamps	270
Gluck Rib Shears	296
Goldmann-Fox Scissors	410
Good Tonsil Scissors	41
Gorney Suction Dissector	402
Gosset Abdominal Retractors	164
Gouges	351-353,355-356
Graduated inside	425
Graefe Fine Wound Retractors	117
Knives	14
Nerve and Vessel Hooks	115
Tissue Forceps	63
Grave Vaginal Speculums	211
Gray Forceps	90,195
Green-Armytage Obstetrics Forceps	251
Gross Sponge Forceps	67
Gruenwald Forceps	61
Guedel-Negus Laryngoscopes	9
Guide	259
Guiding Probes	105,106
Guthrie Fine Wound Retractors	117
Guyon Catheter Guide	206

ALPHABETICAL INDEX

Kidney Clamps	200
Urethral Bougies	206-207
Gynaecological Instruments	245
Scissors	43-44

H

Haase Tampo	351
Reposition Forceps	357
Haberer Intestinal Spatulas	150
Haemostatic ATRAUMATA Forceps	267,268
Haemostatic Forceps	70,79-86,92
Haemorrhoidal Forceps	192-193
Hajek Irrigation Cannula	197
Mallets	349
Hajek-Kofler Punches	311
Halogen Replacement Lamp	10
Halle Bone Curettes	345
Raspatories	332
Vascular Spatulas	258
Halsey Needle Holder	98,413
Halsted Delicate Forceps	80,81
Halsted-Mosquito Delicate Forceps	79,81
Handles	7,20,21,137,215, 219,240,259,261, 323,399
Harken Vena Cava Clamps	293
Hartmann Intestinal Clamps	174
Harvey Wire Cutting Scissors	48,388
Harrington Retractors	138
Harrington-Pemberton Retractors	308
Head Bands	3
Lights	4
Mirrors	3
Heaney Hysterectomy Forceps	92,93
Needle Holders	415
Heaney (Hegar) Needle Holders	99
Heath Clip Removing Forceps	111
Mallet	350
Hebra Comedone Extractors	18
Hegar Needle Holders	99,413
Uterine Dilators	221-222
Hegar-Olsen Needle Holders	100
Hegar-Vascular Needle Holders	413
Hegenbarth Clip Applying Forceps	111
Heiss Delicate Haemostatic Forceps	81
Ligature Forceps	89
Heister Mouth Gag	6
Hemingway Bone Curettes	343
Hennig Plaster Spreader	397
Hepp-Scheidle Needle Holders	412
Herberhold Pocket-Accu	4
Herff Membrane Puncturing Forceps	247
Herget Biopsy Forceps	190
Herrick Kidney Pedicle Clamps	201
Hertzler Retractors	164
Rib Spreaders	300
Herz Tendon Seizing Forceps	72
Hess Forceps	62
Hey Groves Bone Holding Forceps	362
Heymann-Knight Nasal Scissors	41
Heywood-Smith Gall Bladder Forceps	196
Haemorrhoidal Forceps	192
Ovum Forceps	231
Sponge Holding Forceps	71
Tongue Forceps	6
Hoepfner Vessel Clamps	292
Hohmann-Aldinger Bone Levers	329
Holzbach Abdominal Retractor	162
Hopkins Plaster Instruments	393
Hose Connection	244

Hosel Retractors	131
Hosemann Choledochus Forceps	195
Hospital Wares	422-432
House Irrigation Cannulae	404
Howarth Raspatories	333
Huber Handle	240
Hunt Tumor & Vessel Forceps	54
Hunter Splinter Forceps	66
Hurd Ligature Needles	104
Hysterectomy Forceps	92-94

I

Incision Surgical Scissors	32
Inge Lamina Spreaders	161
Instrument Boxes	422,423
Instruments for Micro Tubal Operation	236
Interosseous Knife	16,319
Intestinal Clamps	173-180
Forceps	65,168-171
Spatulas	149-150
Intestinal And Pylorus Clamps	183
Iowa Membrane Puncturing Forceps	247
Irrigation Cannulae	257,404
Israel Retractors	127
Ives-Fansler Anusopes	189

J

Jackson Tendon Seizing Forceps	72
Tracheal Tubes	255
Vaginal Speculums	214
Jackson Burrows Retractors	157
Jacobs Tenaculum Forceps	230
Jacobson Bone Curettes	342
Needle Holder	96,419
Jaeger Fine Wound Retractors	117
Jager Tendon Seizing Forceps	72
Jameson Dissecting Scissors	34
Needle Holder	99
Jansen Bone Curettes	342,343
Bone Rongeurs	366,367
Forceps	61
Head Light with Plastic Band	4
Raspatories	336
Retractors	151
Jars	423,424
Jenkner Instrument set for Tunnelling and Pulling-through Vascular Grafts	261
Jeweler Forceps	52
Bulldog Clamps	77
Joll (Friedman) Retractors	157,220
Jones Towel Clamps	75
Jonesco Ligature Needles	104
Jordan Instruments	385
Joseph Bone File	339
Delicate Scissors	29
Fine Wound Retractors	117
Nasal Knives	18
Raspatories	331
Judd-Allis Tissue Grasping Forceps	168
Judd-Masson Bladder Retractors	204

K

Kader Intestinal Spatula	149
Kalt Needle Holders	96,417

V

ALPHABETICAL INDEX

Littlewood Tenaculum Forceps	230	Mayo-Adams Retractors	154
Liver Retractor	145	Mayo-Harrington Scissors	36,409
Lloyd-Davis Sigmoid Anastomosis Forceps	185	Mayo-Hegar Needle Holders	99,413
Lloyd-Davies Rectal Scissors (Goligher's)	46	Mayo-Lexer Scissors	37,406
Lockhart-Mummery Probes	107	Mayo-Noble Scissors	36
Locklin Scissors	41	Mayo-Robson Intestinal Clamps	180
Lockwood Intestinal Grasping Forceps	169	Mayo-Stille Scissors	35,36,406
Logan modif. Reill Self-Retaining Retractors	151	Mc Indoe Forceps	56
Lopez-Reinke Tonsil Dissector	402	Tissue Forceps	64
Lorna Towel Clamps	76	Mc Kenty Raspatories	331
Loute Wire Tightener	383	Mcintosh Laryngoscopes	10
Love-Gruenwald Rongeurs	314,316,317	Mead Bone Rongeurs	367
Lower Forceps	90,194	Mallets	348
Lowman Bone Clamps	364	Raspatories	333
Lowman-Gerster Bone Clamps	364	Measuring Instruments	11
Lowman-Hoglund Bone Clamps	364	Medicine Cups	424
Lucae Forceps	61	Spoons	424
Lucas Bone Curettes	343	Membrane Puncturing Forceps	247
Chisels	352	Meniscus Knives	378,379
Gouges	352	Forceps	377
Luethy-Beck Needle Holders	416	Mercedes Retractor	306
Luer Bone Rongeurs	366,368	Metacarpal Saw	322
Haemorrhoidal Forceps	192	Metal Cups	424
Retractors	123	Round Boxes	424
Tracheal Tubes	255	Method Pot	426
Luer-Friedmann Bone Rongeurs	365	Metzenbaum Dissecting Scissors	26,38,407,408
Luer-Koerte Gall Stone Scoops	198	Metzenbaum-Fino Dissecting Scissors	407,408
Luer-Stille Bone Rongeurs	371,372	Meyer Reposition Forceps	357
Lung Dissecting Forceps	65	Meyerding Retractors	120,134
Grasping Forceps	290	Michel Clip Applying and Removing Forceps	111
Spatulas, Retractors	138-143,308-309	Rhinoscopic Mirrors	7
Luxation Lever	330	Micro Dissecting Scissors	23-25
		Dissecting Scissors Bayonet	25
		Forceps	52,53
		Jeweller Types Forceps	52
		Ligature Forceps Bayonet	53-54,87
		Needle Holders	96-97,420
		Suture Tying Forceps	52
		Micro-2000 Needle Holders	420
		Micro-Adson Forceps	55,62,87
		Micro-Halsted Delicate Forceps	79
		Microscopic Forceps	55
		Middeldorff Retractors	130
		Mikulicz Forceps	86
		Intestinal Spatula	149
		Peritoneum Forceps	91
		Retractors	144,145
		Milium Knives	18
		Miller Laryngoscopes	9
		Rasps	340
		Millin Bladder Neck Spreader	205
		Bladder Retractors	204
		Center Blade for Retractors	204
		Ligature Holding Forceps	101
		Lobe Grasping Forceps	205
		Mills Gall Duct Scissors	196
		Mirror Handles	7
		Mirrors for Head light	4
		Mixer Dissecting and Ligature Forceps	89,90,292
		Gall Duct Forceps	195
		Mixer-O'Shaughnessy Forceps	89
		Modell Piccolo Cotton Applicators	109
		Mod. USA Plaster Spreader	397
		Modell Tubingen Retractors	135
		Mollison Self-Retaining Retractors	154
		Molt Raspatories	333
		Moeltgen Goniometer	11
		Moncorps Milium Knives	18
		Mosquito Atraumata Forceps	267
		Morris Anastomosis Clamps	186
		Ascending Aorta Cross Clamps	276

M

Mac Donald Raspatories	333
Magill Forceps	8
Maier Sponge Forceps	68
Maltz Bone Rasps	339
Mallets	348-350
Mannerfelt Osteotomes	351,352
Raspatories	334
Retractors	119
Markwalder Rib Rongeurs	297
Marquardt Bone Rongeurs	368
Martin Meniscus and Cartilage Forceps	377
Needle Holders	414
Pelvimeters	246
Retractors	135
Tenaculum Forceps	228
Uterine Probes	224
Vaginal Speculums	218
Martini Bone Curettes	342
Masing Retractors	122
Masson Needle Holders	99
Masson-Luethy Needle Holders	99
Mathieu Foreign Body Forceps	205
Needle Holders	101,415
Rectal Specula	188
Retractors	124
Vaginal Speculums	215
Mathieu-Kocher Needle Holders	415
Mathieu-Ryder Needle Holders	416
Mathieu-Stille Needle Holders	101
Mathieu-Vascular Needle Holders	415
Mayo Gall Duct Probes	197
Safety Pin	76
Scissors	35-37,408
Uterine Probes	224

ALPHABETICAL INDEX

Polyaethylen Splint Material	236
Polypus and Ovum Forceps	231,232
Pool Suction Tube	400
Post Mortem Knives	13
Potts-De Martel Gall Bladder Scissors	196
Potts-Smith Forceps	412
Needle Holders	412
Scissors	39,40,410
Powder Pot	427
Strewer	427
Pozzi Tenaculum Forceps	227
Pratt Organ Grasping Forceps	74
Rectal Specula	188
Pressure Clamps	94,184,193,276
Price Thomas Bronchus Forceps	295
Probes	106-109,385
Proctoscopes	189
Protection Caps (Steinmann Pins)	382
Providence-Hospital Delicate Forceps	79
Punches	310-312
Putti Bone File	341

Q

Quervain Bone Levers	324
Quinby Delicate Scissors	29

R

Rabiner Percussion Hammer	1
Ragnell Scissors Flat Point	26,410
Ramley Sponge Holding Forceps	70
Randall Endometrial Biopsy Curettes	237
Kidney Stone Forceps	203
Rankin Delicate Forceps	80
Raspatories	331-338
Rasps	339-341
Razors	22
Blade Holders	19
Recamier Ovum Curettes	243
Uterine Scoops	241
Rectal Scissors	46
Speculas	187-188
Reill Cutting Pliers	389
Drilling Chucks	383
Reposition Forceps	357
Replacement Lamps	10
Reposition Forceps	357,358
Resection Knives	14,319
Retractors	5,117,148,151-160,
For Cervical Spine	164-167,308
For Cervical Vertebral Column	159,164,167
For Deep Surgery	160
With Treangle Handles	134-135,144-145
	119
Reverdin Intestinal Spatula	150
Needles	102
Reynolds Dissecting Scissors	34
Rib Holding Forceps	297
Raspatories	298-299
Rongeurs	297
Shears	296
Spreaders	300-303,307
Ricard Abdominal Retractors	162
Richardson Retractors	132
Richardson-Eastman Retractors	132
Richter Vaginal Retractors	220
Ring Handle Bulldog Clamps	264,284
Robin Towel Clamps	76

Rochard Retractors	147
Rochester-Carmalt Haemostatic Forceps	86
Rochester-Ochsner Haemostatic Forceps	84
Rochester-Pean Haemostatic Forceps	83
Roeder Towel Clamps	75
Rohrschneider Needle Holder	96
Rollet Fine Wound Retractors	117
Rongeurs	313-318
Rose Retractors	123
Roser-Koenig Mouth Gag	6
Roettgen-Ruskin Bone Rongeurs	369
Round Bowls	426
Handle Needle Holders	97
Metal Boxes	425
Pliers	387
Roux Retractors	124
Rudd Haemorrhoidal Ligators	193
Rulers	11
Rumel Forceps	89
Rumel-Belmon Tourniquets	259
Ruskin Bone Rongeurs	369
Ruskin-Liston Bone Cutting Forceps	374
Russ-Modell Tissue Forceps	65
Rust Amputation Saws	321
Ryder Needle Holders	414
Ryder-Vascular Needle Holders	414

S

Saalfeld Knife	18
Saddle Hooks	119
Saenger Ovum Forceps	252,253
Safety Pins	76
Salenius Meniscus Knives	379
Salpingograph	260
Samii Tissue Grasping, Tumors Forceps	54
Sarot Needle Holders	414
Satinsky Anastomosis Clamps	293
Scissors	40
Satterlee Amputation Saws	322
Sauerbruch Retractors	129
Sterilizing Cases	428
Sauerbruch-Coryllos Rib Rongeurs	297
Saupe Cilia Forceps	66
Scalp Flap Forceps	251
Scalpel Handles	20,21
Knives	14,15,18
Scaphoid Gouges	351
Scapula Retractors	139,308
Schaaf Cilia Forceps	66
Schaedel Towel Clamps	75
Schede Bone Curettes	344
Scheinmann Biopsy Tip	240
Scherback Vaginal Speculums	219
Schimmelbusch Ether Mask	6
Sterilizing Drum	422
Schink Dermatomes	22
Schmid Irrigation Cannulae	257
Vascular Spatula	258
Schmieden Guiding Probes	106
Schmieden-Dick Ligature Needles	105
Schneider Pelvimeters	246
Raspatories	336
Schoemaker-Loth Needle Holder	100
Ligature Scissors	47
Schoenborn Retractors	122
Schroeder Organ Grasping Forceps	74
Tenaculum Forceps	227-229
Uterine Scoops	241
Schubert Biopsy Forceps	238

ALPHABETICAL INDEX

Schulz Bioptome	260	Spurling Rongeurs	314,316,317
Schulze Salpingograph	245	Sputum Cup	425
Schumacher Biopsy Forceps	239	St. Marks Retractors	148
Biopsy Tips	240	St. Martin Forceps	62
Bone Levers	329	Stacke Probes	109
Sternum Shears	296	Stamm Bone Cutting Forceps	373
Umbilical Cord Scissors	45,248	Standard Dissecting Forceps	57
Schumacher mod. Wagner Bone Levers	329	Scissors	30,31,405
Schwarz Traction Bows	382	Tissue Forceps	63
Scissors	23-51	Steinmann Pins	382
With Tungsten Carbide Inserts	405-411	Stellbrink Bone Rongeurs	365
Scoville-Richter Self-Retaining Retractors	158	Stelzner Rectal Scissors	46
Screw Driver	381	Sterilizing Baskets/Trays	431,432
Scudder Stomach Clamps	182	Cases	430
Sedillot Raspatories	336	Drums	422
Segond Myomatome	17,236	Forceps	55,424
Seidl DBP Biopsy Forceps	239	Sternal Puncture Needle	208
Vaginal Specula	211	Sternberg Cheek and Lip Retractor	5
Seiffert Probes	109	Retractors	123
Self Centering Forceps	363	Sternum Instruments	296
Self Retaining Retractors	151-156, 158	Sterotomy Spreaders	304-305
Laminectomy Retractors	155-156	Stethoscopes	2
Sellors Rib Spreader and Contractor	307	Stevens Dissecting Scissors	26,33
Semb Bone Holding Forceps	297,360	Needle Holders	417
Bone Rongeurs	372	Stieglitz Splinter Forceps	66
Dissecting and Ligature Forceps	291	Stille Bone Rongeurs	370
Rib Raspatories	299,337	Chisels	353
Rib Rongeurs	297	Dissecting Scissors	37
Semken Delicate Forceps	56,62,411	Gouges	353
Semm Abdominal Retractors	166	Kidney Clamps	201
Vaginal Specula	210	Osteotomes	353,354
Senn-Miller Retractors	123	Plaster Shears	395,396
Sequestrum Forceps	359	Stille-Barraya Dissecting Forceps	170
Seutin Plaster Scissors	51,394	Stille-Ruskin Bone Rongeurs	370
Sewall Raspatories	332	Stomach Clamps	182
Seyffert Vaginal Specula	210	Storing Cases	422,429,430
Siebold Uterine Scissors	44	Strack Scissors	48
Sigmoid Anastomosis Forceps	185-186	Strainer for Tissues	244
Silicone Operating Pad	236	Stratte Needle Holders	414
Silver Dermatomes	22	Strassburger Tissue Forceps	65
Simon Bone Curettes/Scoops	241,346	Strassmann Elevating Forceps	234
Fistula Hooks	121	Strully Scissors	40
Retractors	121,135	Subramanian Aorta Clamps	280
Uterine Scoops	241	Suction Cannula	309,400,401,404
Wound Retractors	218	Curettes	244
Simplex Cheek and Lip Retractor	5	Handles	399
Simpson Obstetrics Forceps	250	Hose Connection	244
Uterine Probes	224	Instruments	309,398-404
Simpson-Braun Obstetrics Forceps	249,250	Raspatories	402
Sims Gynaecological Scissors	43,409	Tubes	309,400-404
Rectal Specula	187,188	Surgical Scissors	30-32,405
Uterine Curettes	242	Suture Hook	106
Uterine Probes	224	Instruments	102-104
Vaginal Specula	211	Scissors	411
Sims-Maier Sponge Forceps	69	Suture Instrument Sets	112
Sims-Siebold Uterine Scissors	44	Swab Holder	191
Skin Retractors	117	Swedish Pattern Forceps	58
Smellie Perforator	254	Syme Suture Needle	104
Smillie Meniscus Knives	379	Synovectomy Rongeurs	365
Smith Bandage Scissors	49	Sypert Bone Curettes With Hartpress Handle	347
Somer Elevating Forceps	234	Systrunk Nail Splitting Scissors	32,392
Spatulas	109		
Special Bone Levers	330		
Retractors	157		
Spencer Ligature Scissors	47		
Spencer-Wells Haemostatic Forceps	83		
Sphincteroscopes	189		
Splint Guide	236		
Splinter Forceps	66		
Sponge Forceps	67-71		
Holding Forceps	70-71		

T

Tablet Tray	425
Tager Special Bone Levers	330
Takahashi Rongeurs	313
Tampers	351
Tangential Occlusion Clamps	271-272
Taylor Percussion Hammer	1

ALPHABETICAL INDEX

Teale Tenaculum Forceps	229	Unna Extractor	18
Tendon Hooks	121	Ureter Forceps	205
Interlacing Forceps	72	Urethral Bougies Urinary Instruments	206
Seizing Forceps	72	Uterine Curettes	241,242
Tenotomes	14-15	Depressor	224
Tessier Bone Curettes	346	Dilators	221,222
Thole Pelvimeter	246	Dressing Forceps	225,226
Thoms-Gaylor Biopsy Forceps	238	Elevating Forceps	233-235
Thoracic Retractors	306	Flushing Tube	245
Thorek Scissors	40	Probes	224
Thorpe Corneal Forceps	55	Scissors	43,44,409
Thyroid and Vaginal Retractors	157,220	Scoops	241
Tiemann Organ Grasping Forceps	74	Secretion Scoop	237
Tissue Forceps	62-65	Tenaculum Forceps	227-230
Grasping Forceps	54,70,71,73,74, 168,170,171	US-Army Retractors	124
Tobold Tongue Depressor	5		
Toennis Dissecting Scissors	34	V	
Fine Wound Retractors	117	Vacuum Curettes	244,398
Needle Holders	100	Vaginal Clamps	93-94
Vascular Spatulas	258	Retractors	157,217,218,220
Toennis Wire cutting Plier with T.C	421	Speculas	209-219
Toennis-Adson Dissecting Scissors	34	Vaginal and Wound Retractors	218
Tongue Depressors	5	Van Buren Bone Holding Forceps	359
Forceps	6	Vannas Micro Spring Scissors	23,24
Tourniquets	259	Vario Retractors	136,137,215
Tonsil Dissector	402	Vascular Dilators	257
Forceps	86	Spatulas	258
Knives	17	Vein Retractors	122
Scissors	41	Vena Cava Clamps	270,271,293
Towel Clamps	75,76	Venae Sectio Set	113-114
Townley Caliper	11	Verbrugge Bone Holding Forceps	363
Trachea Retractors	118	Verbrugge-Muller Bone Levers	328
Tracheal Dilators	256	Vernier Caliper	11
Hooks	256	Vessel Clamps	292
Tubes	255	Hooks	115,116
Traction Bows	382	Irrigation Cannulae	257
Hooks	380	Scissors	39
Transformer	4	Vidal Lupus Scraper	18
Transparent Suction Hose	244	Virchow Knife	13
Trays	426,430	Vise Grip Pliers	387
Trelat Raspatories	331	Micro Forceps	52
Triangular Basins	427	Volkmann Bone Curettes	342,344
Trigeminal Knife	17	Bone Retractors	125,126
Trocars	208,398,399		
Troeltsch Forceps	61	W	
Troemner Percussion Hammer	1	Wachenfeldt Clip Applying Forceps	111
Trousseau Tracheal Dilators	256	Wagner Vessel Hooks	115
Troutman-Chris Blade Holder	19	Wagner Bone Levers	327
Tubal Seizing Forceps	236	Mallets	349
Tubbs Aortic Dilators	260	Meniscus Knives	378
Tuffier Intestinal Spatula	150	Raspatories With Hartpress Handle	338
Rib Spreaders	300	Rongeurs	318
Tissue Grasping Forceps	168	Walb Knife	13
Tungsten Carbide Instruments	405-419	Walter Gouges	353
Tunnelling Instruments	261	Wangensteen Forceps	412
Turnable Biopsy Forceps	190	Intestinal Grasping Forceps	170
Tuttle Lung Dissecting Forceps	65	Needle Holders	99
Lung Grasping Forceps	290	Wartenberg Pinwheel	1
		Waugh Tissue Forceps	64
U		Weber Aorta-Anastomosis Clamps	282
Ueckermann-Denker Cryothyrotomy Trocar	255	Webster Needle Holders	98
Uffendorde Bone Curettes	343	Wecker Eye Scissors	23
Ultra-Light Forceps	59,172,262	Weil-Blakesley Rongeurs	313
Umbilical Cord Scissors	45,248	Weissbarth Vaginal Speculum	217
Universal Bandage Scissors	50	Weitlaner Self-Retaining Retractors	152-153
Handle	240	Weller Meniscus and Cartilage Forceps	377
Trays	430	Wertheim Anastomosis Clamps	275
Trocars	208		
Wire Cutting Scissors	48,388,411		

ALPHABETICAL INDEX

Clamps and Forceps	92-95,201
Gynaecological Scissors	43
Hysterectomy Forceps	92
Parametrium Clamps	93
Wertheim-Cullen Clamps and Forceps	95
Wieder Tongue Depressor	5
Wiener Modell Suture Hooks	106
Wikstroem Dissecting and Ligature Forceps	291
Wilde Forceps	61
Willett Scalp Flap Forceps	251
Williams Intestinal Grasping Forceps	170
Lung Grasping Forceps	290
Williger Bone Curettes	342,344
Elevators	324
Raspatories	331
Retractors	120
Winter Ovum Forceps	252
Wire Catcher	385
Cutters	388
Cutting Pliers	387,389,391,421
Cutting Scissors	48,388,411
Extensions	380,381
Guides	384
Holding Forceps	386,387
Saws	323
Tightener	380,383,385
Tightening Pliers	386
Traction Bow	380,381
Twister	385
Winkelmann Circumcision Clamps	207
Wolff Plaster Breakers	397
Wound Retractors	117-118,122
Wound and Tracheal Hooks	256
Wrenches	380
Wrigley Obstetrics Forceps	250
Wullstein Self-Retaining Retractors	153
Suction Tube	403

Y

Yankauer Suction Cannulae	309,401
Yasargil Ligature Forceps	53,87
Micro Forceps	53
Micro Needle Holders	96,97,420
Micro Scissors Bayonet Shape	25
Rongeurs	317
Suction Cannulae	309,403,404
Tumor & Vessel Forceps	54

Z

Zenker Forceps	89
Retractor	139
Ziegler Head band	3
Head Mirror	3
Milium Knives	18
Zielke Gouges	335